

The Rollei logo is displayed in white text on an orange rectangular background in the top left corner. The background of the entire page is a silhouette of a person carrying a tripod and camera against a sunset over water.

Rollei

Stativ | Tripod **Compact Traveler Star S2**

Bedienungsanleitung | User Guide

For German | English | French | Dutch | Spanish
Italian | Portuguese | Swedish | Hungarian

www.rollei.de

Bedienungsanleitung	3
Manual instruction	4
Notice d'utilisation.	5
Gebruiksaanwijzing	6
Instrucciones	7
Istruzioni	8
Instruções	9
Instruktioner	10
Használati utasítás	11

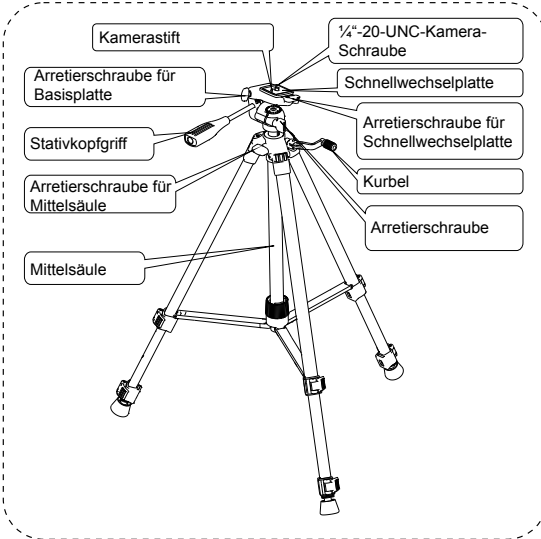

Modell	Segmente	Max. D	Höhe zus. geklappt	Min. H.	Nicht-zentr. H	Max. H	Gewicht	Tragkraft
CTStar S2	3 Seg.	24 mm	56 cm	53 cm	126 cm	150 cm	1,290 kg	2,5-3,5 kg

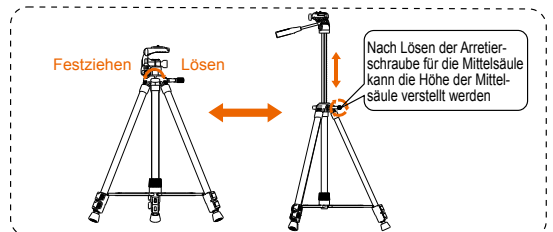
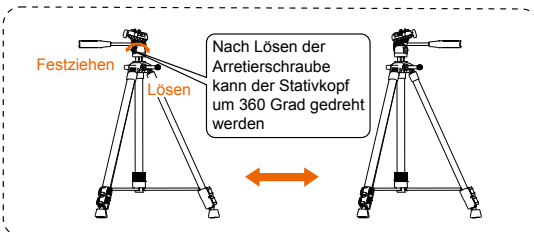
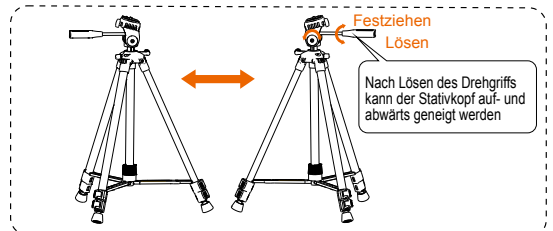
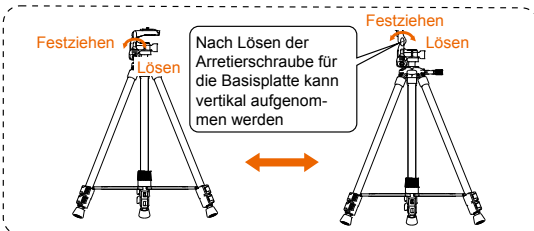
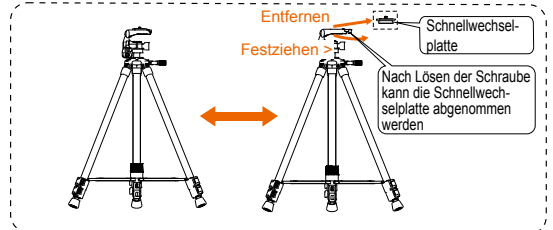
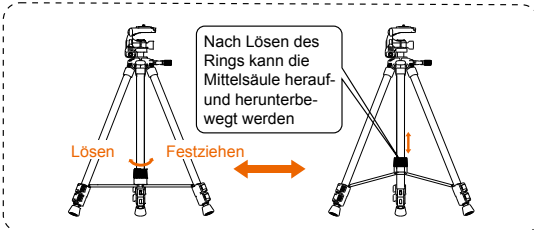
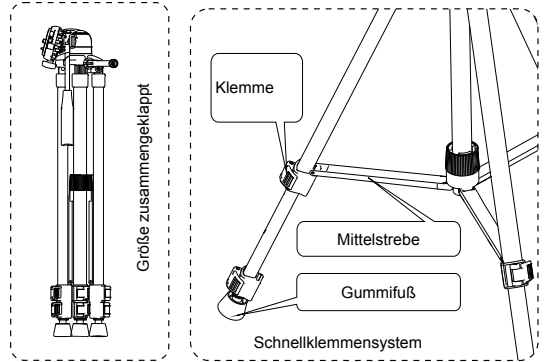

Eigenschaften des Stativs

1. Dieses kompakte Stativ wurde speziell für Foto-Einsteiger entwickelt. Es ist kompakt, leicht, bedienungsfreundlich und mit einem 3-Wege-Stativkopf versehen. Die Beine verfügen über bedienungsfreundliche Schnellklappen.
2. Die Beine verfügen über bedienungsfreundliche Schnellklappen.

* Abweichungen beim tatsächlichen Produkt aufgrund von Produktverbesserungen möglich.



Model	Section	Max. D	Folded H.	Min. H	Non-center H	Max. H	Weight	Loading
CTStar S2	3-sec.	24mm	55cm	53cm	126cm	150cm	1,290kg	2.5-3.5kg

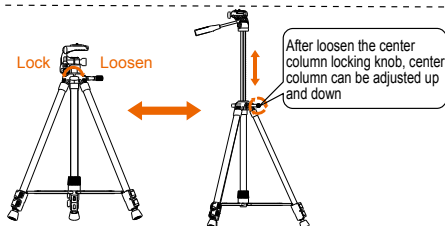
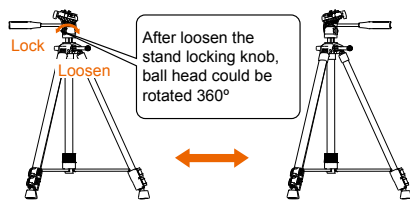
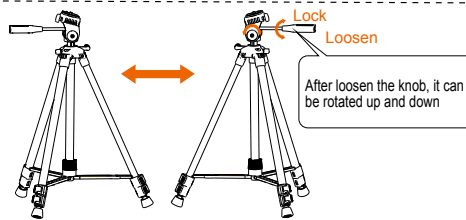
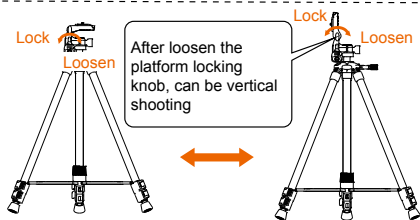
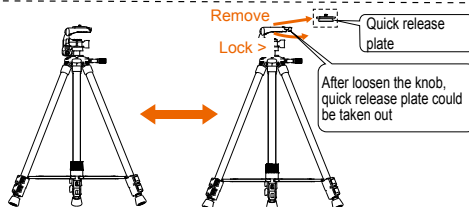
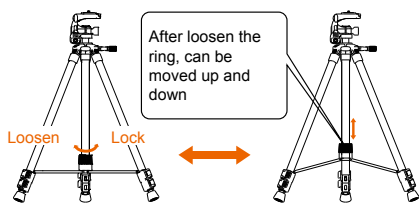
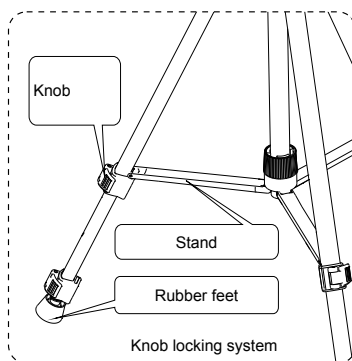
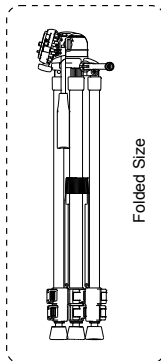
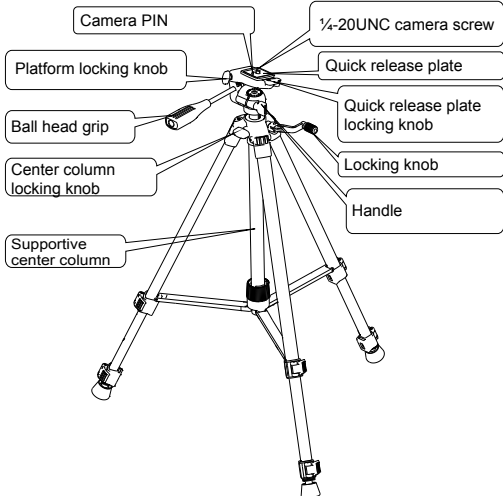

Tripod Features

1. This compact tripod is specially designed for entry-level shooting lovers. It's compact, lightweight, easy operation and with 3-way ball head shooting function.
 2. Quick locking leg structure system, easy operation.
- *To improve the product, any change in design/specification will be refer to real product.

Modèle	Section	Diam. max.	H replié	H min.	H sans col. cent.	Hauteur max.	Poids	Charge max.
CTStar S2	3 Seg.	24 mm	56 cm	53 cm	126 cm	150 cm	1,290 kg	2,5-3,5 kg

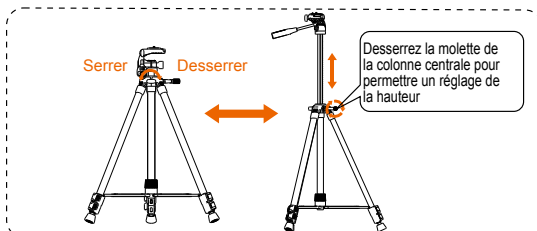
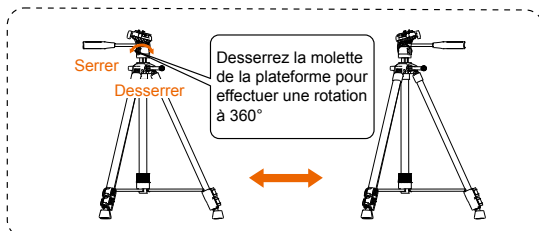
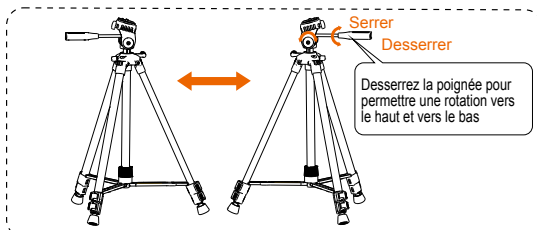
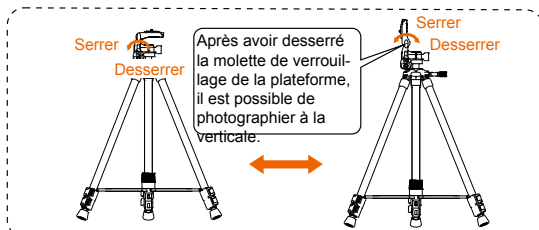
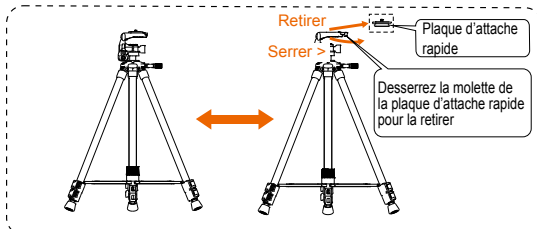
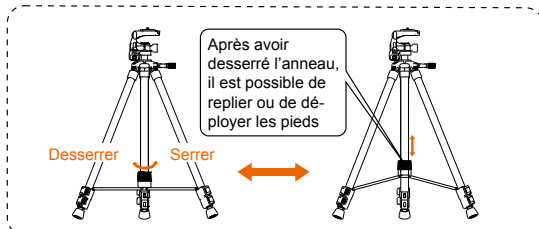
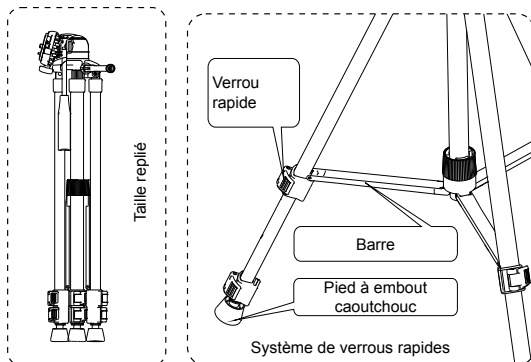
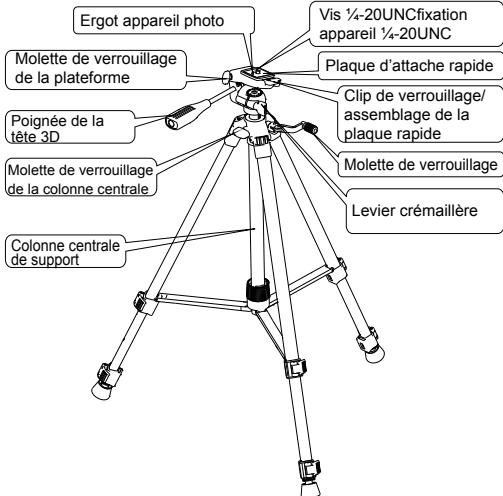

Caractéristiques du trépied

1. Ce trépied compact a été spécialement conçu pour les photographes débutants. Il est compact, léger, facile à utiliser et avec une tête réglable en trois directions.

2. Système de verrous rapides des pieds facile à utiliser.

*En cas de changement du design/des caractéristiques en vue d'améliorer les produits, veuillez vous reporter au produit d'origine.

Model	Segment	Max. D	Hoogte ingeklapt	Min. hoogte	Niet-midden H	Max. H	Gewicht	Draagvermogen
CTStar S2	3 Seg.	24 mm	56 cm	53 cm	126 cm	150 cm	1,290 kg	2,5-3,5 kg

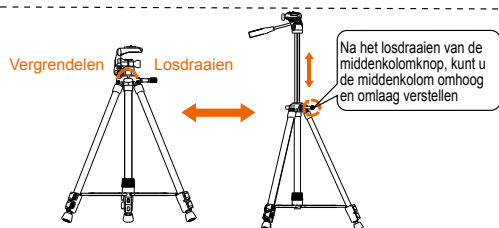
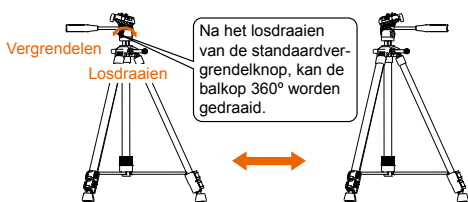
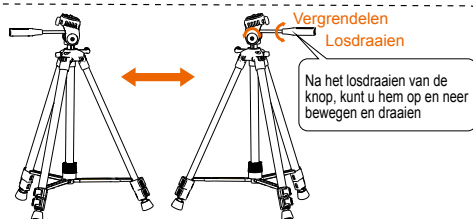
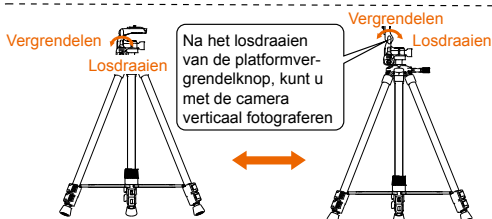
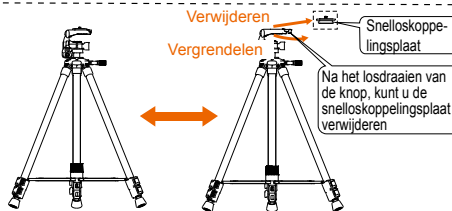
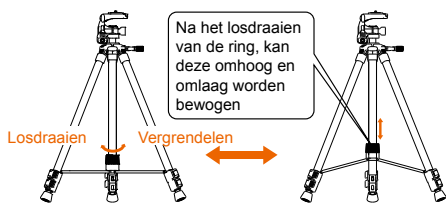
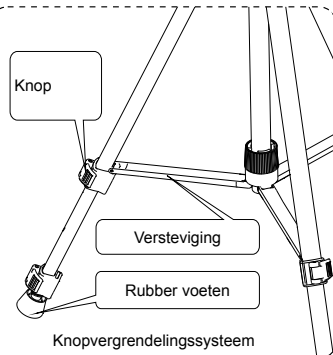
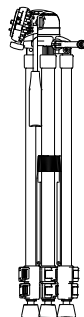
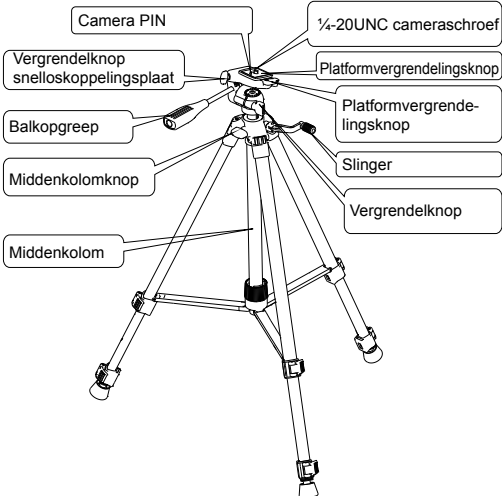

Kenmerken van driepootstatief

1. Dit compacte driepootstatief is speciaal ontworpen voor beginners. Het is compact, lichtgewicht, eenvoudig te bedienen en met 3-weg balknop fotografeerfunctie.
2. Systeem om pootconstructie snel te vergrendelen, eenvoudig in gebruik

*In verband met productverbeteringen zijn wijzigingen in de vormgeving en in de technische gegevens voorbehouden.

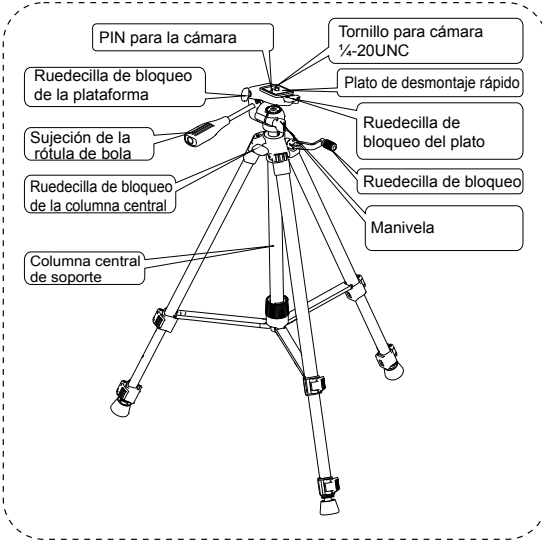

Modelo	Sección	D. máx.	Alt. plegado	Alt. mín.	Alt. no central	Alt. máx.	Peso	Carga
CTStar S2	3 s	24 mm	56 cm	53 cm	126 cm	150 cm	1,290 kg	2,5-3,5 kg

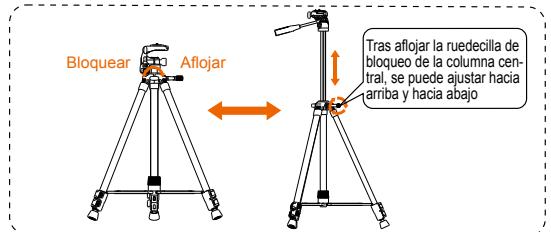
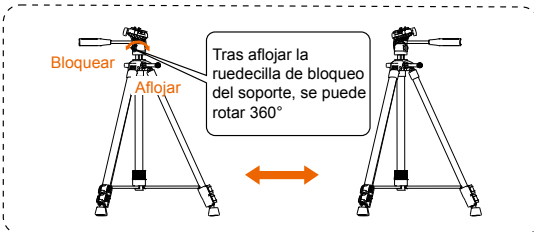
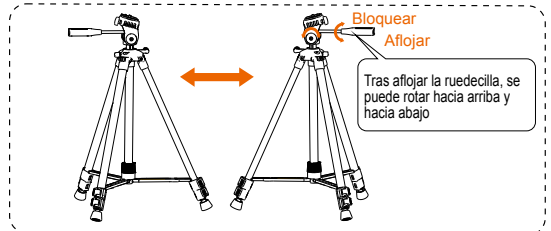
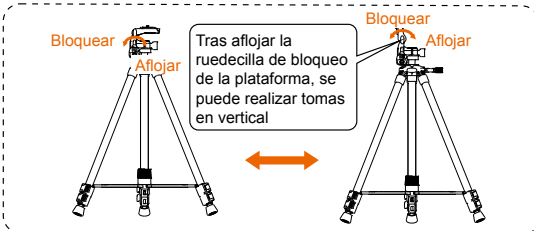
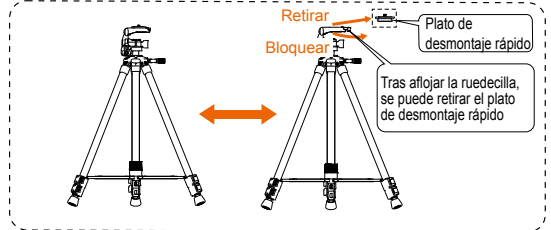
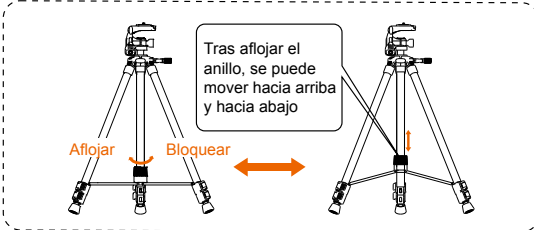
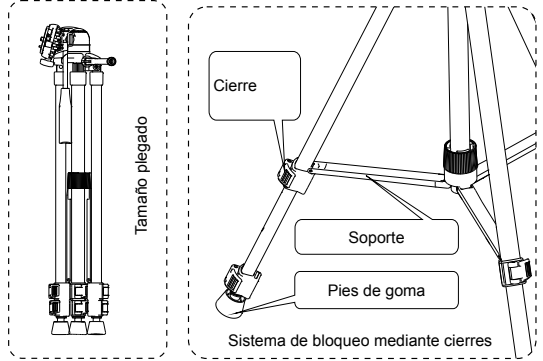

Características del trípode

1. Este trípode compacto ha sido especialmente diseñado para principiantes. Es compacto, ligero, fácil de usar y la rótula de bola puede colocarse en 3 posiciones.
2. Sistema de bloqueo rápido de las patas, fácil de usar.

*En aras de mejorar el producto, todos los cambios de diseño/especificaciones según el producto real.

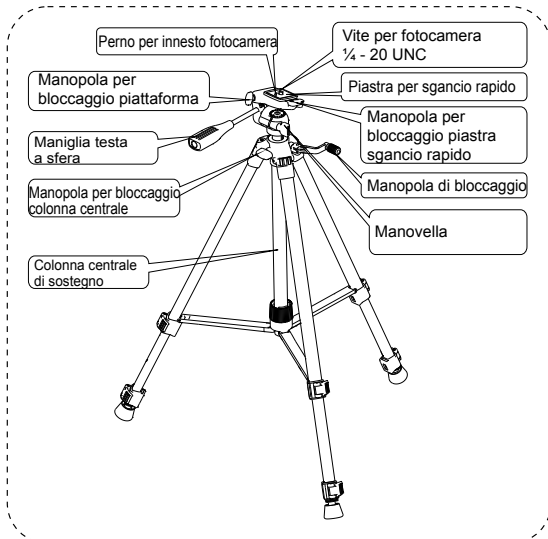

Modello	Sezioni	Diam. max	Lungh. da chiuso	Alt. min.	Alt. non centrale	Alt. max.	Peso	Portata
CTStar S2	3-sec.	24 mm	56 cm	53 cm	126 cm	150 cm	1,290 kg	2,5-3,5 kg

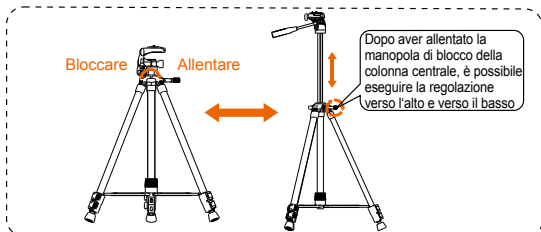
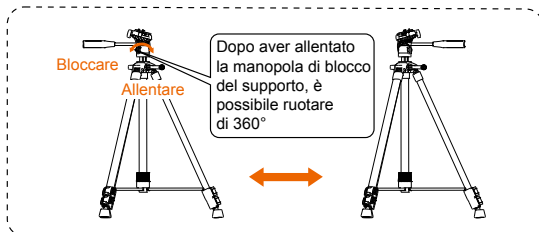
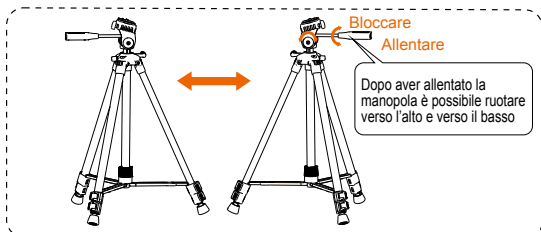
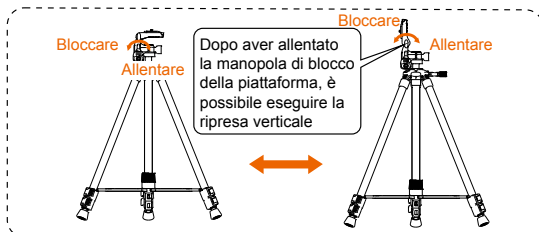
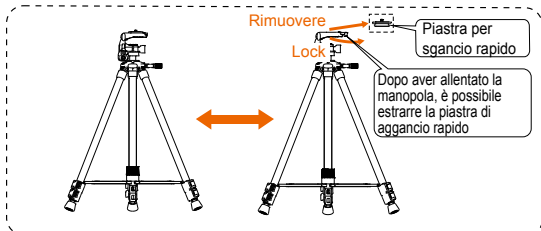
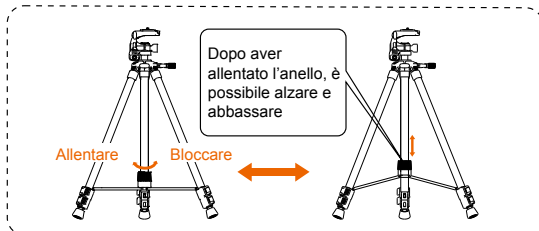
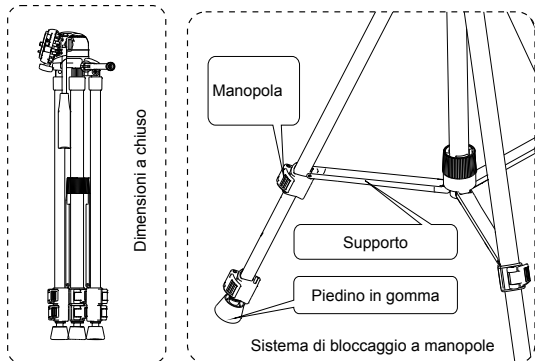

Caratteristiche del treppiede

- Questo treppiede compatto è stato progettato appositamente per fotografi principianti. È compatto, leggero, facile da usare, dotato di testa a sfera con funzione di ripresa tripla.
- Sistema con struttura gambe a bloccaggio rapido, utilizzo semplice.

*Per migliorare il prodotto, qualsiasi variazione nel progetto / nella specifica farà riferimento al prodotto reale.

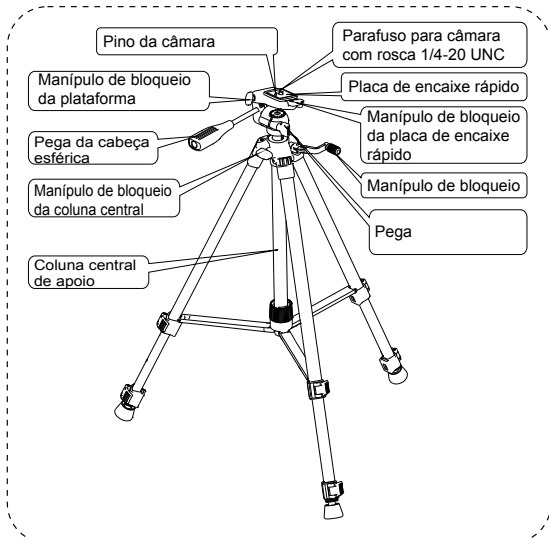

Modelo	Seção	Diâm. máx.	Alt. dobrado	Alt. mín.	Alt. não central	Alt. máx.	Peso	Carga
CTStar S2	3 sec.	24 mm	56 cm	53 cm	126 cm	150 cm	1,290 kg	2,5-3,5 kg

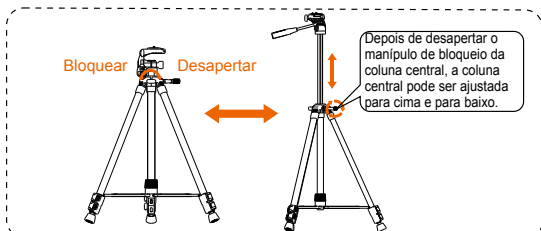
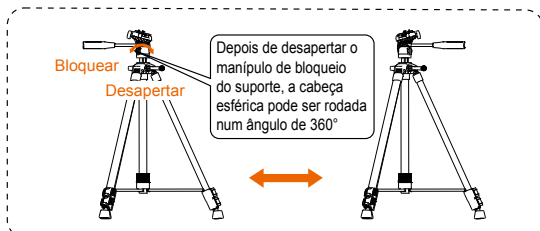
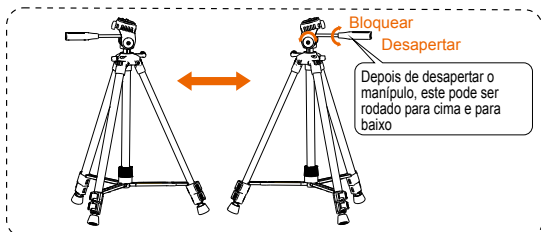
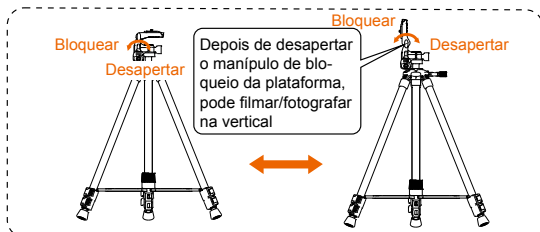
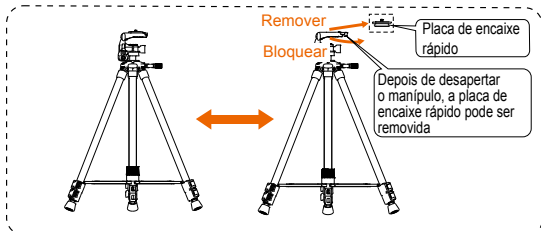
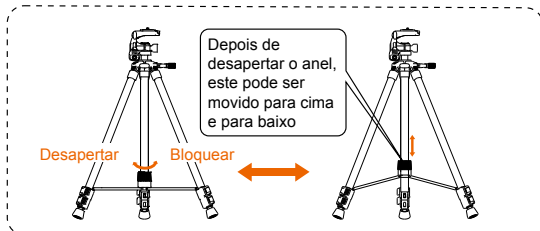
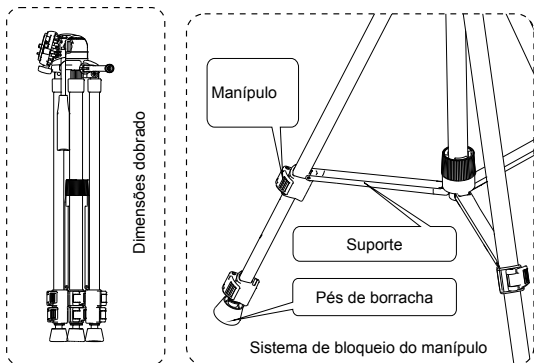

Características do tripé

- Este tripé compacto foi especialmente concebido para principiantes entusiastas da fotografia. É compacto, leve, de fácil utilização e com cabeça esférica para filmar/fotografar em 3 direções.
- Sistema de estrutura de pernas de bloqueio rápido e de fácil utilização.

*Para melhorar o produto, todas as alterações ao design/especificações poderão variar de acordo com o produto real.



Modell	Sektion	Max.D	Hopkvikt H.	Min.H	Ocentr.H	Max.H	Vikt	Lastvikt
CTStar S2	3 SEK.	24 mm	55 cm	53 cm	126 cm	150 cm	1,290 kg	2,5-3,5 kg

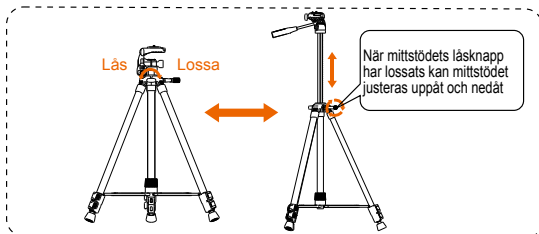
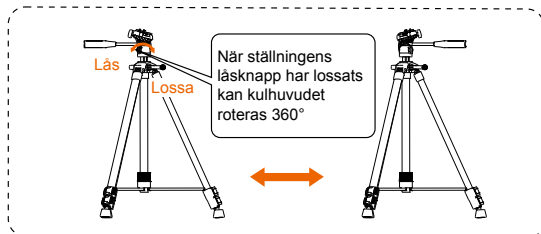
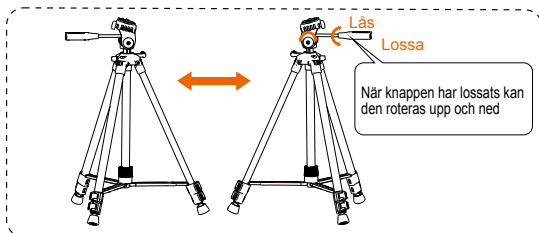
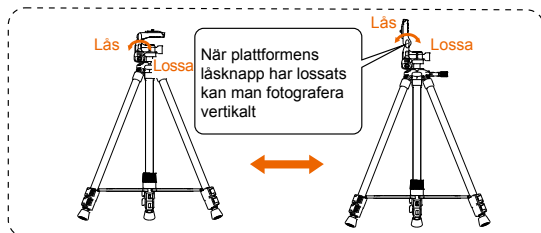
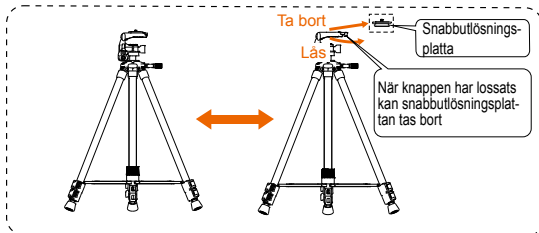
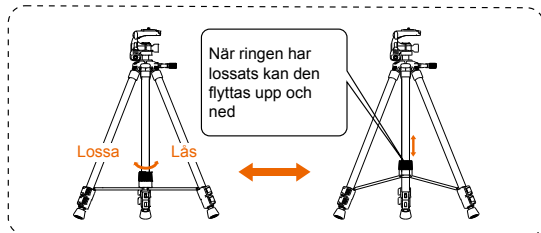
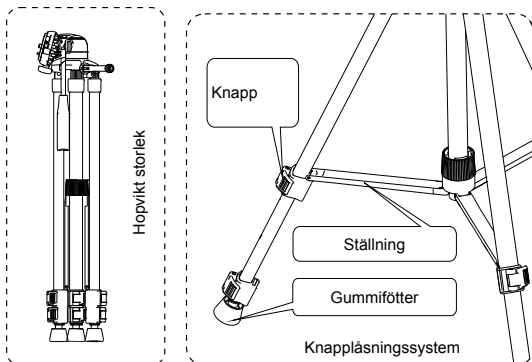
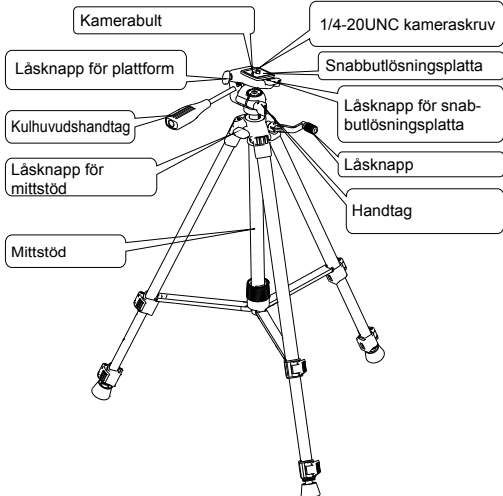

Tripodens egenskaper

1. Denna kompakta tripod är speciellt utformad för nybörjarfotografer. Den är kompakt, har lätt vikt, är enkel att använda och har ett 3-vägs kulhuvud för fotograferingsfunktioner.
2. Benstruktur med snabbblås-system, enkel att använda.

*För att förbättra produkten kan det ha utförts ändringar på den verkliga produktens design/specifikationer/parametrar.

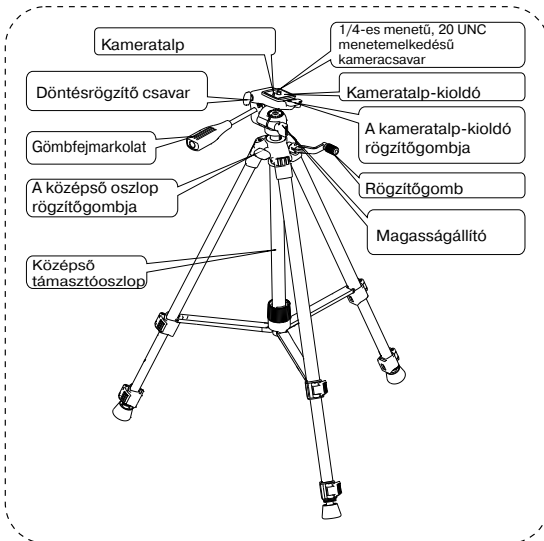

Modell	Tag	Max. átm.	Összecsukott m.	Min. m.	Közép nélküli m.	Max. m.	Súly	Terhelés
CTStar S2	3 tagú	24 mm	56 cm	53 cm	126 cm	150 cm	1,290 kg	2,5-3,5 kg

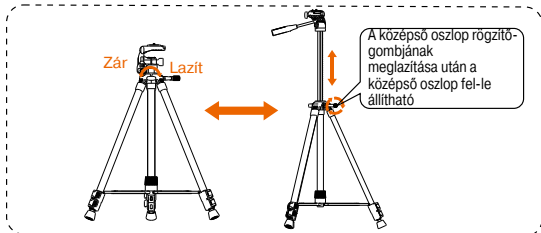
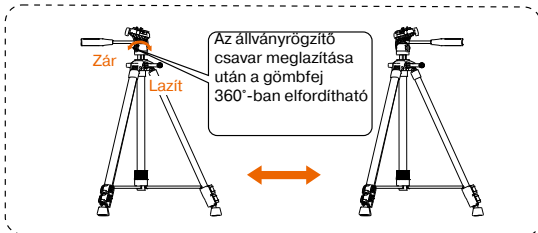
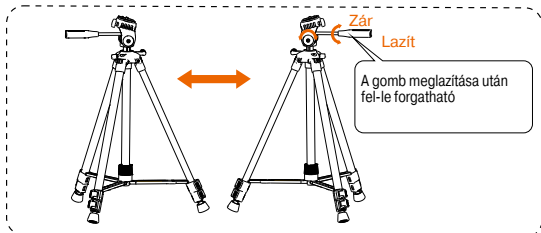
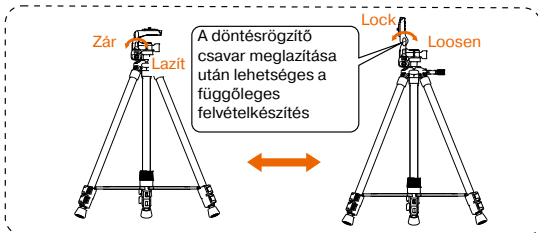
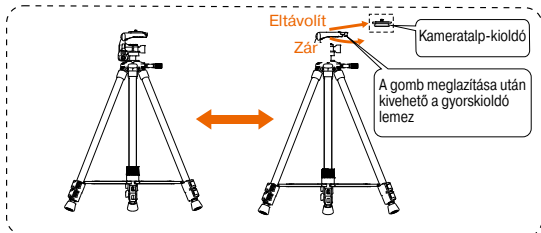
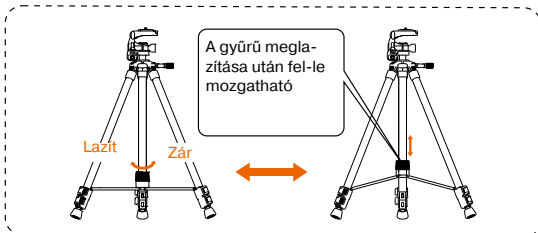
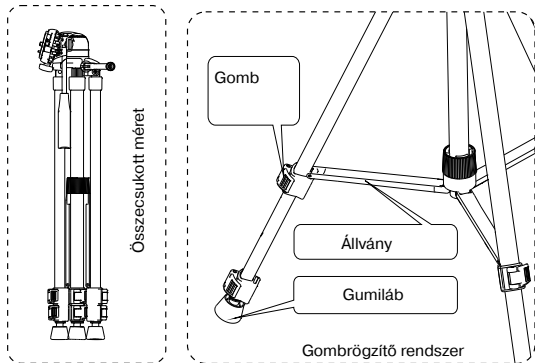

A háromlábú állvány jellemzői

- Ezt a kompakt háromlábú állványt kifejezetten a kezdő fényképezésk számára tervezték. Kompakt, könnyű, könnyen kezelhető, és háromféle gömbfejes fényképezési funkcióval rendelkezik.
- Gyorszáras láb felépítési rendszer, könnyű kezelhetőség.

*A termék fejlesztése érdekében a termékek kialakítása/műszaki adatai a tényleges termék függvényében változhatnak.

Rollei

Rollei GmbH & Co. KG
In de Tarpen 42
22848 Norderstedt

Service-Hotline:
+49 40 270750277

 /rollei.foto.de

 @rollei_de

www.rollei.de