

Blitzgerät 58F

Flash Unit 58F



Gebrauchsanweisung | Instructions

in German | Deutsch | French | Spanish | Italian | Portuguese

Blitzgerät 58F

Flash Unit 58F

Gebrauchsanweisung 4–56

Manual instruction 57–110

Notice d'utilisation 111–164

Instrucciones 165–218

Istruzioni 219–272

Instruções 273–226



Flash Unit 58F

Safety Instruction	58	Wireless master mode (command) (Canon)	88
Specifications	59	Wireless Master Mode (command) (Nikon)	93
Nomenclature	60	Wireless Instruction Mode (SLAVE C/SLAVE N)	97
Display Icons	62	Light Sensing Mode	98
Basic operation	63	Multi Lighting Applications	99
Auto-Focus Auxiliary AF Lamp	63	2.4G Light Applications	99
Battery Installation	65	Light Transmission Application	100
Attach the Flash to the Camera	66	Wireless light-sensing application (S1 / S2)	101
Turn Power On	67	Automatic Save Function	102
Common Flash Mode	68	Setting Position and Operation range	103
Flash exposure bracketing	69	Using the Built-In Reflecting Card	103
On-line Operation	70	Bounce Flash	104
Other Automatic Flash		Use the Built-In Wide Angel Diffuser	105
Shooting Mode	71	Voice Prompts	106
Manual Flash Mode M	72	Custom Menu Setting	107
Stroboscopic Flash Mode (Multi)	72	Disposal Battery Warning	109
LED Light	74	Conformity	110
High Speed Sync / Rear-Curtain Sync	74		
Wireless Flash Mode	76		
2.4G wireless master mode (Canon)	78		
2.4G wireless master mode (Nikon)	83		
Wireless Slave Mode (Wireless 2.4G SLAVE)	87		

Thank you for purchasing this Rollei Flash Unit.

Please read this manual carefully before using the Flash Unit and use it correctly according to the given instructions.

Safety Instruction

1. Never trigger the Flash Unit around flammable gas or liquid gas (such as gasoline and solvents)! There is the risk of explosion!
2. Neither shoot with the Flash Unit at drivers of cars, buses or trains, nor the riders of motorcycles and bicycles. They may be temporarily blind of the bright light which can cause traffic accidents.
3. Never trigger the Flash Unit directly in front of your eyes! Using the Flash Unit directly at people or animal's eyes might damage the retinas and cause serious visual disturbances, even blindness.
4. Only use the batteries listed in this manual!
5. Never place the batteries in high-temperature environment, such as under the sun or in the fire.
6. Remove the drained battery from the Flash Unit, as the alkaline liquid can exude from the battery which will damage the Flash Unit.
7. Keep the Flash Unit and battery charger away from water (such as the rain).
8. Protect the Flash Unit from extremely hot or damp environment.
9. Do not put the Flash Unit in the glove box of the car dashboard. Do not put any light-proof items before or on the reflection shield when the Flash Unit will be triggered. Please take care that there is no dirt on the reflection as otherwise the high energy that the Flash Unit emits, will burn the item or damage the reflection shield.
10. Never open the Flash Unit by yourself! There will be the danger of electric shocks. Non-professional personal cannot fix the components within the Flash Unit.
11. If fast continuous shootings under full light output are done, you need to stop for 15 minutes after every 10 continuous flashes to prevent overheating.
12. If the flash is used in full light output with continuous repetitions in combination with a zoom position of less than 35 mm, the diffuser will get hot due to high energy.
13. The quick change of temperatures might cause vapour condensation.
14. Never use any defected batteries for this Flash Unit.

Technical Features	
Guide Number	58 (ISO 100, 180 mm)
Motorised Zoom	18 - 180 mm, manual / automatic zoom
TTL Flash Mode	TTL, M, FEB, 2.4G Master ,2.4G Slave, S1, S2, Multi
Wireless Trigger Distance	Light pulse, induction flash light
WL Transmission Range	Indoor up to 30 m Outdoor up to 50 m
WL Transmission range 2.4 GHz	Up to 50 m
Swivel Reflector	Tilt angle : -7° up to +90° Rotation angle left / right: 0° up to +180°
Slave Group and Unit 2.4 G	16 Slave communication channels (1–16) 3 Slave unit groups (A, B, C)
Slave Group and Unit Infrared	4 Slave communication channels (1-4) 3 slave unit groups (A,B,C)
Color Temperature Flash	5500K
LED Colour Temperature	5500 ± 200 k colour (white)
LED Power	3W
Flash Duration	1/200 seconds – 1/20,000 seconds
High Speed Synchronisation	Up to 1/8,000 seconds
Manual Flash Control	1/128 - 1/1 step 0.3 EV, a total of 22 grade fine-tune gear
Peripheral Interface	Hot shoe, USB (for firmware updates only)
Recycle Time	2.3 seconds
Power	11.1 V lithiumion battery
Lighting Time	100 ~ 1500 times (batteries/rechargeable)
Additional Functions	Sleep mode, overheating protection
Size	BxHxT: 75 x 200 x 60 mm
Weight	437 g (without any batteries)

Subject to technical changes. Canon and Nikon are registered trademarks, Canon and Nikon products are trademarks or registered trademarks of Canon and Nikon.

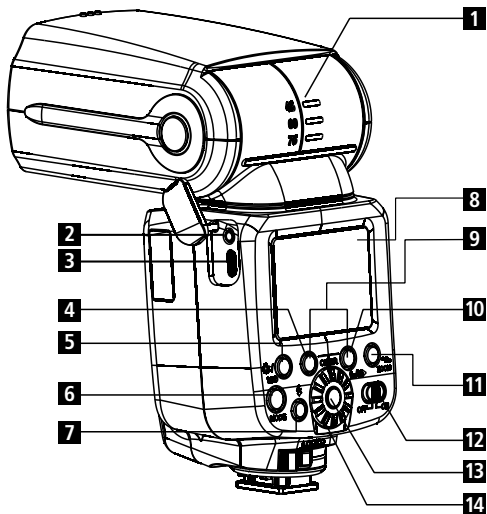

- 1** Flash head tilt angle scale
- 2** Synchronous sockets
- 3** Micro USB socket
- 4** Wireless option button
- 5** LED
- 6** MODE button
- 7** Test button / flash charger indicator
- 8** LCD
- 9** Clear (restore factory settings if both buttons are pressed at the same time)
- 10** High Speed /Rear Curtain Sync
- 11** Zoom / Wireless parameter settings button / Custom function settings button
- 12** ON/OFF switch
- 13** Middle button
- 14** Dial

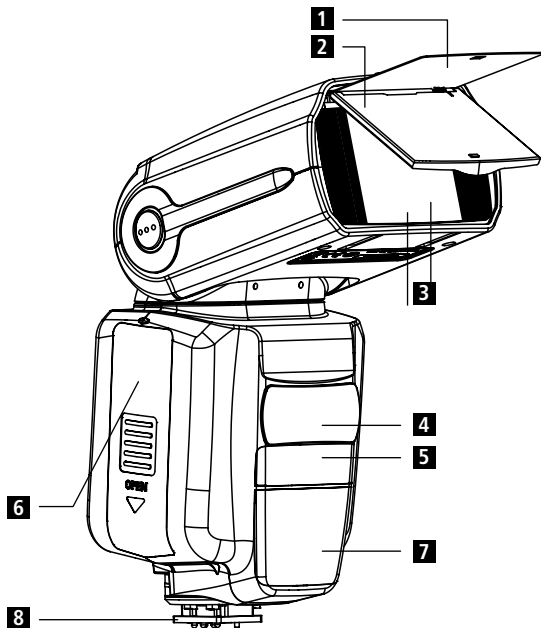

- 1** Built-in reflection plate
- 2** Built-in wide-angle diffuser
- 3** Flash head
- 4** LED illuminator

- 5** Flash sensor
- 6** Battery cover
- 7** Auto focus auxiliary lamp
- 8** Hot shoe mount

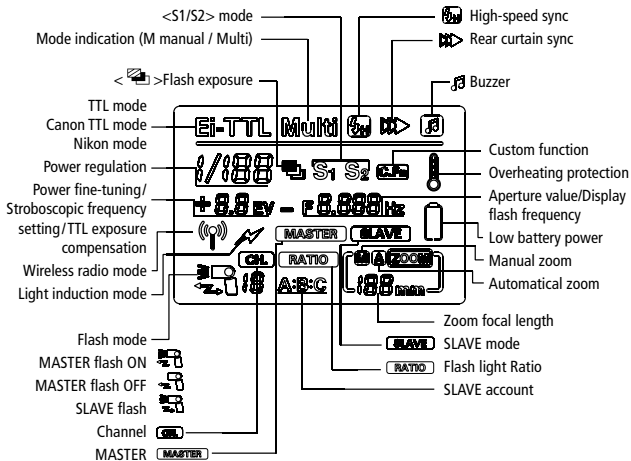

Auto-Focus Auxiliary AF Lamp

When working under dark conditions, the Automatic AF which is positioned in the middle of the flash light, may temporary project a red light to assist focusing. If this lamp disturbs the subject that should be shooted you can switch to manual focus (M) or to custom function (Fn – 08).

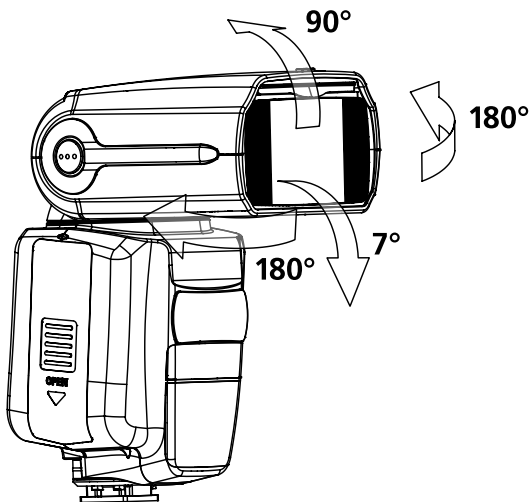

This flash unit can be rotated up to 90° and downwards up to 7°. Furthermore a horizontal rotating from "left to right" and "right to left" by 180° is possible. Rotating the flash to the ceiling or wall can make the images look more natural.

Suitable power supply

- 11.1V Lithium battery (included in the packaging).

Note:

- Do not short-circuit the battery positive and negative electrodes.
- Do not disassemble the battery
- Do not immersed in the water or into the fire.
- Charge only with the specified charger.

Battery Installation

1. Open the battery cover by sliding it in the direction of the arrow shown and open the battery compartment.
2. Install the battery according to the Lithium battery mark arrow into the battery compartment. Make sure that the battery contact is positioned correctly.
3. Close the battery cover.

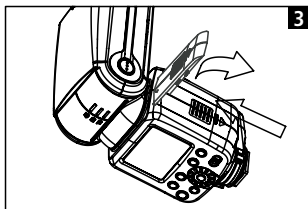
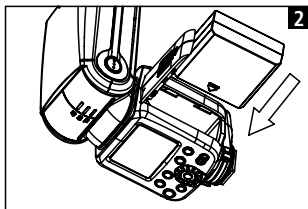
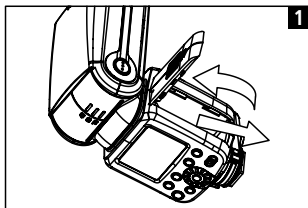

Attach the Flash to the Camera

1. Prepare to install the Flash Unit
Rotate the locking plate up to the highest point (direction shown by the arrow).
2. Install the Flash Unit
Install the Flash Unit's mounting support into the hot shoe of your camera.
3. Lock the Flash Unit
Tighten the locking plate by rotating in the direction shown by the arrow.
4. Detach the Flash Unit
Rotate the locking plate up to the highest point, then remove the Flash Unit from the hot shoe mount.

Note:

- Make sure that the Flash Unit and camera are turned off. Do not detach forcibly the Flash Unit from the camera.

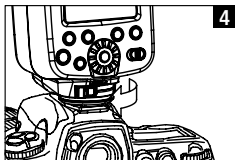
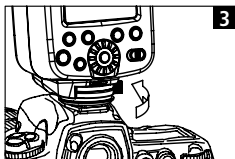
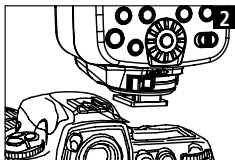
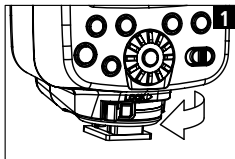

Basic operation

Turn Power On

Slide the power button to "ON" to turn on the flash and slide the button back to "OFF" to turn off the device.

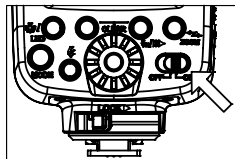

Power management

In order to save battery power and avoid battery leakage the default setting are as follows:

If the flash unit is turned on but is not used within 60 seconds the flash will automatically go in standby. The flash can be awoken by pressing any button. If the flash unit is not in use for more than 30 minutes the flash will automatically shut down.

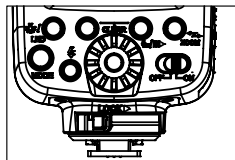

If the flash unit will not be used for a long period of time it is recommended to turn it off by the power switch and remove the batteries. Before removing the batteries please make sure that the flash is turned off.

If the flash unit's capacitor is fully charged, the flash key button will light up. This indicates that the flash is ready to trigger.

Firmware upgrading

This flash supports firmware upgrading through the UPS port.

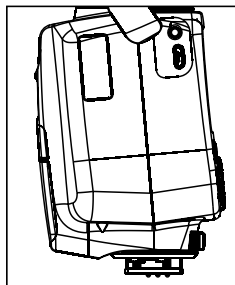

Common Flash Mode

This flash has different modes:

TTL (full automatic), M (manual), Multi (stroboscopic).

Automatic TTL Flash Mode

Set the camera's shootin mode to <P> (program automatic exposure) or to <□> (auto) if the flash should work automatically.

Select the Flash Mode

Press the MODE button so often until the LCD shows [TTL].

Set the Flash Exposure Compensation Value.

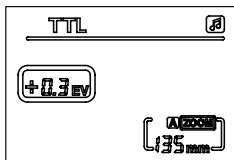
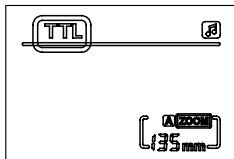

1. Rotate the dial to set the exposure compensation: Rotate it clockwise to increase the value and counter clock-wise to decrease it.

The compensation value has a range of -3.0EV to +3.0EV:

0EV → +0.3EV → +0.7EV → +1.0EV → +1.3EV → +1.7EV → → +3.0EV

0EV → -0.3EV → -0.7EV → -1.0EV → -1.3EV → -1.7EV → → -3.0EV

Flash Exposure Bracketing

By using FEB the flash exposure will be automatically changed, which helps in conditions of invariable background exposure. You can take three flash shots while automatically changing the flash output according to 1/3 to plus or minus.

After the FEB is done, the flash will go back to the standard settings that have been used before. (This can be turned off in the custom settings.)

For using FEB set your camera into the mode "single shot" and ensure that the flash is ready. Connect the Canon camera and set on the flash exposure value surrounded exposure.

If a Nikon camera is connected the flash exposure information will not be shown on the flash. You need to refer to the camera settings.

FEB Setting Surrounded by Exposure Value (effective for Canon cameras only)

Press the middle button to enter the settings of the exposure value.

1. The exposure value can be adjusted by the dial. Rotate it clockwise to increase or counter clockwise to decrease the exposure value.
2. The exposure value has a range of 0 to 3.0
3. The values are:

0	1	1.3	1.7	2.0	0.3	0.7	2.3	2.7	3.0
---	---	-----	-----	-----	-----	-----	-----	-----	-----

4. After the settings are done press again the middle button to exit the settings.

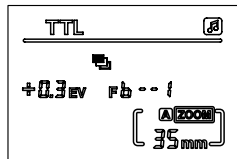
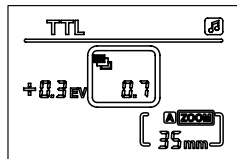

On-line Operation (mounted on camera)

Flash TTL Mode

If the flash is connected to a Canon camera through the hot shoe, the screen of the flash will show E-TTL to represent the current metering system.

If the flash is connected to a Nikon camera through the hot shoe, the screen of the flash will show i-TTL to represent the current metering system.

The Nikon system does not support flash on FEB settings. To realize surrounded the exposure function on Nikon (BKT), please refer to the camera settings.

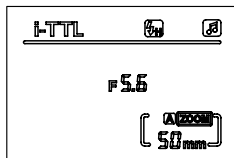
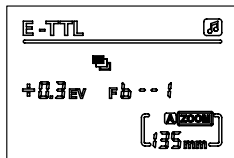
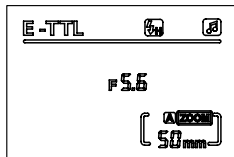

Flash Exposure Lock (FEL/FV)

The "Flash Exposure Lock" locks the correct flash exposure setting for any part of the scene. When <TTL> is displayed on the panel, please connect the flash to your camera correctly. For Canon cameras press the "FEL" or "*" (AEL auto exposure lock) button. For Nikon cameras press "FV" button. Then the flash will do a preflash and the camera will calculate the appropriate flash output. At this point you have time for re-composition. After finishing you can press the shutter release for shooting pictures.

(This feature requires you to use the camera support itself, therefore please refer to your camera manual settings).

Set the camera's shooting mode to <AV/A>(Aperture priority AE), <TV/S> (Shutter priority AE) or <M> (Manual) and you can use E-TTL / i-TTL auto flash.

TV/S	Select this mode when you want to set the shutter speed manually. The camera then automatically set the aperture matching the shutter speed to obtain a standard exposure. If the aperture display blinks, it means that the background exposure will be underexposed or overexposed. Adjust the shutter speed until the aperture display stops blinking.
AV/A	Select this mode to manually set the aperture value. The camera is automatically set to match the aperture shutter speed to achieve standard exposure. If the background is dark (such as at night), a slow sync speed will be used to obtain a standard exposure of both, the main subject and background. Use the MASTER flash for the standard exposure of your subject. Use the slow shutter background exposure standards. Since a slow shutter speed will be used for low-light scenes, using a tripod is recommended. If the shutter speed display blinks, the background will be under- or overexposed. Adjust the aperture until the shutter speed display stops blinking.
M	Select this mode if you want to set both, the shutter speed and the aperture manually. Use the MASTER flash for standard exposure. The exposure of the background is obtained with the shutter speed and aperture combination you have set.

If you use the <DEP> or <A-DEP> shooting mode, the result will be the same as using the <P> (Program AE) mode.

Flash Sync Speeds and Apertures Values

	Shutter Speed Setting	Aperture Setting
P	Set Automatically (1/60 sec.~1/Xsec.)	Automatic
A	Set manually (30 sec.~1/Xsec.)	Automatic
V	Set Automatically (30 sec.~1/Xsec.)	Manual
M	Set manually (buLb,30 sec.~1/Xsec.)	Manual

Note:

The Canon camera mode: P, TV, AV, M, A - DEP, green frame Nikon mode: P, S, A, M

Manual Flash Mode M

If a manual exposure is needed, you can set the flash brightness according to your own needs. The incremental setting of the flash output can be adjusted from 1/128 to 1/1 power in 1/3 steps.

Select the flash mode

Press the mode button repeatedly until M is shown on the display.

Power setting

The power of the flash output can be adjusted by rotating the dial (clockwise = increase / counterclockwise = decrease).

- Increase: 1/128→1/128+0.3ev→1/128+0.7ev→...→1/32→...→ 1/1
- Decrease: 1/1→1/1-0.3ev→1/1-0.7ev →...→1/32→...→ 1/128

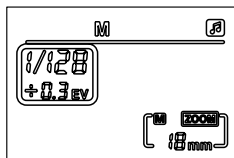
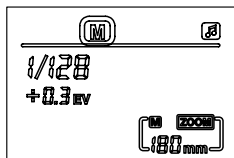

Stroboscopic Flash Mode (Multi)

To properly use the Multi mode, set the camera into Multi mode. If the Multi mode is used, a series of quick flashes will be emitted. Therefore, several flashes can be taken in one photo. These lightning settings are often used when recording moving objects. Please set the flash output power as required, time of flash and flash frequency (every flashes time shown by Hz). Please use a fully charged battery when this mode is used. To prevent the flash head against overheating and damage, do not use more than 10 times strobe flash burst in a row.

Between two repeated exposure operation, let the flash plenty of time for callback.

Select the flash mode

Press the mode button repeatedly until Multi is shown on the display.

Frequency setting

Press the middle button repeatedly until the frequency is highlighted on the display. Rotate the dial clockwise to increase and counterclockwise to decrease the value. The available flash frequency can be adjusted from 1HZ-199HZ.

Set the number of flashes

Press the middle button repeatedly until the number of flashes is highlighted on the display. Rotate the dial clockwise to increase and counterclockwise to decrease the value. The number of flahes can be set from 1 - 40. After the setting is done press the middle button to exit the setting.

Exposure power setting

To adjust the power within the multi mode rotate the dial clockwise to increase and counterclockwise to decrease the value.

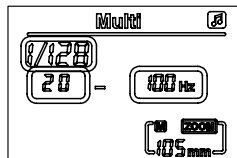
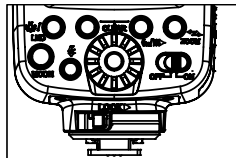
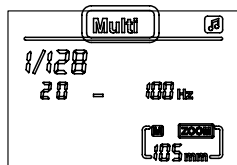

The relational table of flash power and number of flashes

Flash power	1/128	1/64	1/32	1/16	1/8	1/4
Number of flashes	1-40	1-20	1-12	1-8	1-4	1-2

Note: Using stroboscopic mode there is a formula to determine the shutter speed. You can also choose a smaller or longer shutter speed. The shutter speed should be used in "B" mode of the camera (BULB = long exposure).

- Shutter speed = Times of flash ÷ Flash frequency (Hz)

Press the LED button for about 3 seconds to switch between the LED mode and ordinary flash mode. When the screen only displays LED, the LED lamp is turned ON. Then the flash settings are blocked.

High Speed Sync / Rear-Curtain Sync

High Speed:

High speed sync enables to have a high shutter speed sync with the flash and the camera. The maximum shutter speed is up to 1/8000s. When using a flash to shoot an outdoor portrait, as well as other needs under the strong light source and large aperture this mode is used.

Rear Curtain Sync:

With a slow shutter speed a light trail following the subject can be created. Therefore the flash fires just before the shutter closes.

1. If the flash unit is used with a Canon camera under E-TTL or M mode: If you want to use the high-speed sync / Rear-curtain sync function correctly, press the high speed sync button to open the corresponding function
2. If you are using a Nikon camera, you cannot directly set the high speed sync mode in the flash unit. This needs to be done by the camera menu which needs to be set to "FP". When the flash is connected to the camera, the display shows  immediately. For the rear curtain sync this needs to be done in the same way as for the high speed sync (there is nothing shown on the flash unit's display).

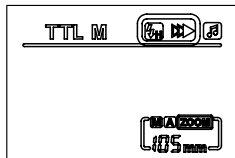

High Speed Sync / Rear-Curtain Sync

Off-camera High Speed Sync (not mounted on camera):

Within the wireless slave mode the flash can receive a high speed sync signal from the master flash.

Note: To use the high speed sync/Rear curtain sync correctly the camera flash mode and shutter speed needs to be set properly.

High speed sync off the camera can be achieved in two ways:

1. Wireless TTL trigger (The trigger needs to support high speed sync)
2. Set the flash unit to slave c or slave n mode
 - a. To achieve the high speed sync in slave c mode, the Canon wireless instructions must be received. The built-in flash of the camera must be the master flash. The maximum sync speed is only 1/200 or 1/250. If you use a Canon camera, the camera itself does not have high speed sync. Therefore you should take an extra flash unit which has a master function and is connected by the hot shoe mount to the camera. The master light will give the signal to the slave light to make it high speed sync.
 - b. To achieve the high speed sync in slave n mode, you can use the built-in flash of the Nikon camera as the built-in flash has the master function. Open the Auto AP function in your camera and use the built-in flash. The built-in flash will send the data only by the lamp, it does not sync in flash.

The camera menu access (only the latest Canon cameras)

The latest Canon cameras support that the flash can be operated through the camera menu. Within the flash control menu of "External flash function settings" and "External flash custom function settings" flash related parameters such as switch E-TTL mode, manual flash mode and multiple flash mode (Multi), wireless flash setting, surrounded by exposure, exposure compensation, the focal length and the function of advanced options can be set.

Wireless Flash Mode

The wireless flash system is composed by multiple wireless flashes. You can create a wide variety of lighting effects like TTL flash etc.

Press the wireless option button to switch between the wireless modes Master 2.4G Canon, Master 2.4G Nikon, Slave 2.4G, Master (infrared Canon), Master (infrared Nikon), Slave C, Slave N, S1, S2 and off. If the master flash is used as main control unit, the slave flash can be operated off the camera.

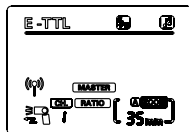

Master Canon (2.4G)



Master Nikon (2.4G)

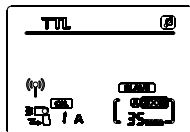

SLAVE (2.4G) mode

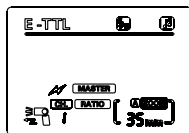

Master Canon
(infrared) mode

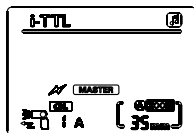

Master Nikon
(infrared) mode

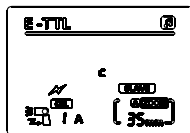

SLAVE C mode

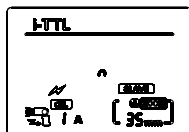

SLAVE N mode

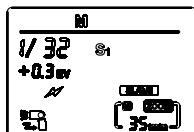

S1 mode

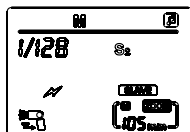

S2 mode

Note:

1. In the wireless slave mode you can change parameters directly on the slave flash. If the infrared control mode is used this is not possible, the mode button is blocked. If the flash is attached to a camera, you can press the shutter but the flash will not fire as it is not connected. You need to leave the slave mode first.
2. In the wireless flash mode the focus indicator light flashes but it can be turned off in the custom settings. Please note that if you want to use it again you need to activate this function.
3. In the wireless slave mode the flash unit will not go into the standby mode as the flash is always waiting to receive signals from the master flash.

2.4G wireless master mode (Canon)

Wireless master control mode (wireless 2.4G MASTER)(Canon)

Press the wireless option button repeatedly until master is shown on the display.

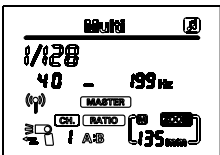
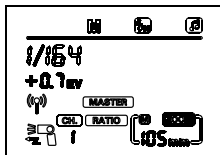
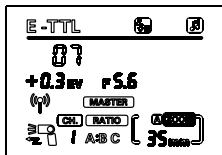

Wireless setting

Master control wireless channel setting

Press the zoom button repeatedly until the number of channel is highlighted. Rotate the dial to set the wireless channel from 1-4.

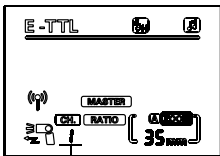

Wireless Channel number

Set the master unit flash On / Off

Set the master flash: Press the zoom button repeatedly until the icon \rightarrow is highlighted. Rotate the dial to set the master flash. If the following icon is shown on the display \leftarrow then the master flash is turned off. If the following icon is shown on the display \rightarrow then the master flash is turned on.

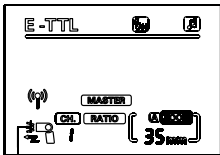

Master flash switch symbol

Note:

- The master flash and the slave unit will have the same modes.
- The power of group A will have the same value as the master flash.
- In the master mode high speed sync is supported but not rear curtain sync.

Full Auto Wireless MASTER Model(Wireless 2.4G MASTER) (Canon):

1. Press the mode button repeatedly until E-TTL is shown on the display.
2. Press the zoom button repeatedly until RATIO is highlighted.
3. Select the flash light ratio

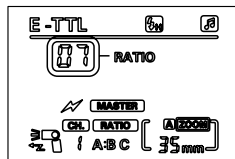
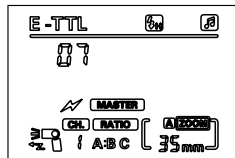
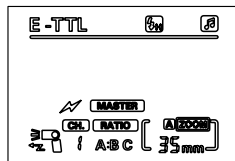

Rotate the dial to set the flash light ratio which can be <RATIO>, <RATIO A:B> or <RATIO A:B:C>. Select the flash ratio <RATIO> and all three slave unit groups will have the same bright output as the master flash. Select <RATIO A:B> and the groups A and B will flash. Furthermore you can set the output brightness for both groups. If <RATIO A:B:C> is selected all three groups will flash and you can set the output brightness for group A and B as well as the power compensation for group C.

4. Set the flash light ratio
Press the middle button until the flash light ratio is highlighted. Rotate the dial to set the flash light ratio and all codes as shown in the table below.

Flash light ratio codes and flash light ratio table

Code	01	02	03	04	05	06	07	08	09	10	11	12	13
RATIO	8:1	5.6:1	4:1	2.8:1	2:1	1.4:1	1:1	1:1.4	1:2	1:2.8	1:4	1:5.6	1:8

5. Set group C exposure compensation <RATIO A:B:C>

Press the middle button until the group C exposure compensation is highlighted and adjust the value by rotating the dial. Press the middle button again to confirm and quit the adjustment.

If <RATIO A:B> is selected the slave units of group C will not flash. If the slave units of group C are directed towards the subject, the subject might be overexposed.

2.4G wireless master mode (Canon)

Manual Wireless MASTER mode (Wireless 2.4G MASTER Canon)

Press the mode button repeatedly until m (manual) is shown on the display of the master unit. Now you can set different flash light ratios for each slave unit group. Use the master unit to finish all the settings.

1. Press the mode button repeatedly until m is shown on the display.

2. Press down the zoom button repeatedly until <RATIO> is highlighted.

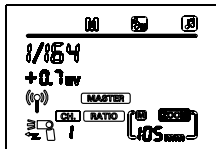

3. Select flash light ratio

Rotate the dial to set the flash light ratio which can be <RATIO>, <RATIO A:B> or <RATIO A:B:C>. Select the flash ratio <RATIO> and all three slave unit groups will have the same bright output as the master flash. Select <RATIO A:B> and the groups A and B will flash and the power output of the units in group A and B can be adjusted on each single unit. Select the flash light ratio >RATIO A:B:C> and all three groups will flash. The power output can be adjusted on each single unit.

4. Set the flash output <RATIO A:B> or <RATIO A:B:C>

Press the middle button until group A is highlighted. Rotate the dial to set the power of group A.

Press the middle button until group B is highlighted. Rotate the dial to set the power of group B.

Press the middle button until group C is highlighted. Rotate the dial to set the power of group C.

2.4G wireless master mode (Canon)

Multi Wireless MASTER mode (Wireless 2.4G MASTER Canon)

Set the master unit into the multi mode. You can set up each slave unit in different flash light ratios. Use the master unit to finish all the settings.

1. Press the mode button on the master unit repeatedly until multi is shown on the display.

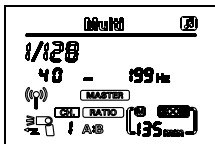

2. Press the zoom button repeatedly until ratio is highlighted.

3. Select flash light ratio

Rotate the dial to set the flash light ratio which can be <RATIO>, <RATIO A:B> or <RATIO A:B:C>. Select the flash ratio <RATIO> and all three slave unit groups will have the same bright output as the master flash. Select <RATIO A:B> and the groups A and B will flash and the power output of the units in group A and B can be adjusted on each single unit. Select the flash light ratio >RATIO A:B:C< and all three groups will flash. The power output can be adjusted on each single unit.

4. Set the flash frequency

Press the middle button repeatedly until the frequency is highlighted. Rotate the dial to set the frequency which is available from 1HZ to 199HZ. After the value is set press the middle button again to enter the setting of the flash number and to exit.

5. Set the times of flash

Press the middle button repeatedly until the number of flashes is highlighted. Rotate the dial to set the number of strobe flashes which is available from 1 to 40. If the flash ration is set to <RATIO OFF> the maximum of number of strobes is limited by the flash output power. If the ratio is set to <RATIO A:B> or <RATIO A:B:C> the maximum times is limited by the output power of group A.

2.4G wireless master mode (Canon)

6. Set the flash output (<RATIO A:B>or<RATIO A:B:C>)

Press the middle button repeatedly until the group A is highlighted. Rotate the dial to adjust the power of group A.

Press the middle button repeatedly until the group B is highlighted. Rotate the dial to adjust the power of group B.

Press the middle button repeatedly until the group C is highlighted. Rotate the dial to adjust the power of group C.

2.4G wireless master mode (Nikon)

Wireless MASTER control mode (wireless 2.4G MASTER) (Nikon)

Press the wireless option button repeatedly until master is shown on the display.

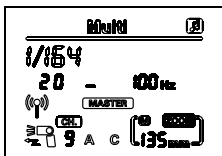
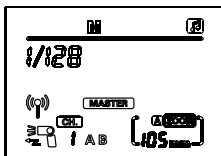
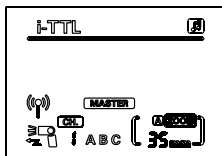

2.4G wireless master mode (Nikon)

Wireless setting

Set the MASTER unit wireless channel

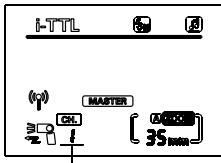

Press the zoom button repeatedly until the number of channel is highlighted. Rotate the dial to adjust the channel between 1 and 16.



Wireless channel number

Set the master unit flash On / Off

You can disable the master unit flash so that only the slave unit's flash is involved in the exposure.

Set the master flash: Press the zoom button repeatedly until the icon  is highlighted. Rotate the dial to set the master flash. If the following icon is shown on the display  then the master flash is turned off. If the following icon is shown on the display  then the master flash is turned on.

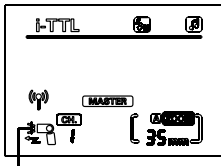

Master flash switch symbol

Note: If a Nikon is the master control unit you can freely set the mode and power of each slave unit group.

2.4G wireless master mode (Nikon)

Automatic wireless / manual master mode (wireless 2.4G MASTER) (Nikon)

If the master unit is in the 2.4G wireless TTL or M mode, the slave unit supports the following modes: wireless off, iTTL or M.

1. Press the mode button repeatedly until the display of the master unit shows iTTL or M

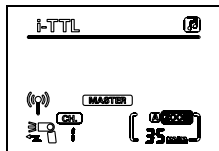

2. Each slave group mode setting

Group A: Press the zoom button repeatedly until group A is highlighted. Rotate the dial to set the group mode to wireless off, iTTL or M. Press the middle button to exit the setting or press the zoom button to go into the group B.

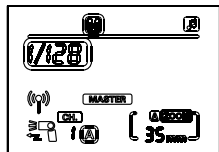

Group B: Press the zoom button repeatedly until group B is highlighted. Rotate the dial to set the group mode to wireless off, iTTL or M. Press the middle button to exit the setting or press the zoom button to go into the group C.

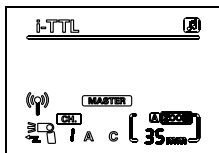

Group C: Press the zoom button repeatedly until group C is highlighted. Rotate the dial to set the group mode to wireless off, iTTL or M. Press the middle button to exit the setting.

If the slave unit group setting is done, only the groups that have a wireless mode are shown on the display, those with wireless off will not be shown.

3. Power setting of each slave unit group

Press the middle button until group A is highlighted to set the power. After the setting is done, press the middle button to exit the setting.

Multi Wireless Master Mode (Wireless 2.4G MASTER) (Nikon)

1. Press the mode button repeatedly until the display of the master unit shows **Multi**

2. Each slave group mode setting

Group A: Press the zoom button repeatedly until group A is highlighted. Rotate the dial to set the group mode to wireless off, iTTL or M. Press the middle button to exit the setting or press the zoom button to go into the group B.

Group B: Press the zoom button repeatedly until group B is highlighted. Rotate the dial to set the group mode to wireless off, iTTL or M. Press the middle button to exit the setting or press the zoom button to go into the group C.

Group C: Press the zoom button repeatedly until group C is highlighted. Rotate the dial to set the group mode to wireless off, iTTL or M. Press the middle button to exit the setting.

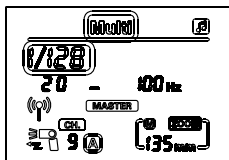
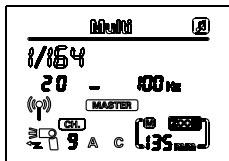

If the slave unit group setting is done, the wireless function can be turned on and off.

ON: The wireless flash group number will be shown on the display.

OFF: The wireless flash group number will not be shown on the display.

2.4G wireless master mode (Nikon)

3. Set the flash frequency

Press the middle button until the frequency number is highlighted. Rotate the dial to set the value which is available from 1HZ-199HZ.

4. Set the times of flash

Press the middle button repeatedly until the number of flashes is highlighted. Rotate the dial to set the value which is available from 1-40.

5. Set flash power

If nothing is highlighted on the display rotate the dial to set the power to the needed value.

You can create 1 to 3 slave units and set a channel for each slave unit. When there are multiple slave units, please ensure that the slave units have the same channel as the master unit.

Slave unit parameter setting

Press the wireless option button repeatedly until 2.4G slave mode is shown on the display.

1. Set the slave unit channel: Press the zoom button repeatedly until the number of channel is highlighted. Then rotate the dial to set the desired channel (1-16).
2. Set the slave unit group: Press the zoom button repeatedly until the group is highlighted. Then rotate the dial to set the desired group (A, B, C).

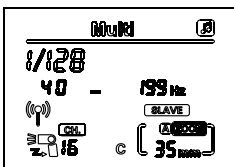
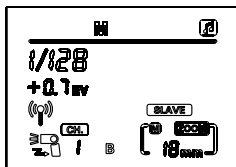
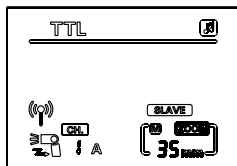

Note: The mode parameters and the focal length on the slave unit will be set by the master flash.

Note: From the wireless transmitter the following modes can be received by the slave unit: E-TTL, iTTL, Manual, Multi, High Speed Sync.

Wireless Master Mode (command) (Canon)

Wireless MASTER mode (command MASTER) (Canon)

Press the wireless option button repeatedly on the master flash to set the master mode.

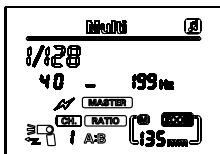
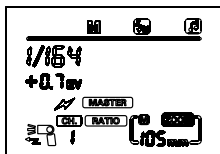
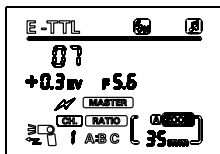

Wireless setting

Set the Master control unit wireless channel

Press the zoom button repeatedly until the channel number is highlighted on the display. Rotate the dial to set the wireless channel (1-4).

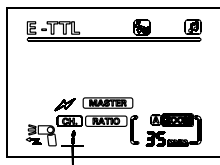



Wireless channels

Set the master unit flash On / Off:

You can turn the master function on and off.

Turn the master on: Press the zoom button until the icon  is highlighted. Rotate the dial to turn it on.

If the icon  is shown on the display, the master function is turned off. If the icon  is shown on the display, the master function is turned on.

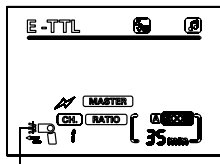

Master flash switch symbol

Note: The master mode does support the high speed sync, but not the rear curtain sync.

Automatic wireless master mode (command MASTER) (Canon)

Press the mode button of the master flash repeatedly to set the E-TTL mode for the automatic shooting.

1. Press the mode button repeatedly until the eTTL mode is set.

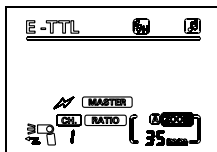

2. Press the zoom button repeatedly until RATIO is highlighted on the display.

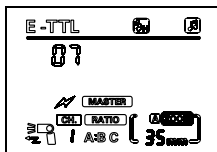

3. Select the flash light ratio

Rotate the dial to set the flash ratio <RATIO>, <RATIO A:B> or <RATIO A B C>. Select the flash light ratio <RATIO> if you want to have on all slave unit the same brightness, exposure compensation and bracketing as the master flash. Select the flash light ratio <RATIO A B> to turn on the flash light of the groups A and B. Select the flash light ratio <RATIO A B C> to turn all slave unit groups on, the power brightness will be set by A and B and c will be the power output compensation.

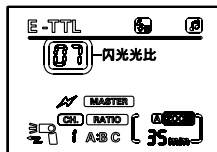

4. Set the flash light ratio.

If the ratio <RATIO A B> is set, press the middle button repeatedly until the flash light ratio is highlighted. Rotate the dial to set the different codes as shown below in the table.

Flash light ratio codes and flash light ratio table

Code	01	02	03	04	05	06	07	08	09	10	11	12	13
RATIO	8:1	5.6:1	4:1	2.8:1	2:1	1.4:1	1:1	1:1.4	1:2	1:2.8	1:4	1:5.6	1:8

Wireless Master Mode (command) (Canon)

5. Set Group C exposure compensation(<RATIO A:BC>)

Press the zoom button repeatedly to select the ratio <RATIO A B C>. Then press the middle button repeatedly until c is highlighted. Rotate the dial to change the value and press the middle button again to confirm the setting and exit.

- If <RATIO A B> is selected the flash units of group C will not fire.
- If the slave unit group C is facing the subject, the subject will be over exposed.

Manual Wireless Master mode (command MASTER) (Canon)

Set the master flash into the manual mode. Different flash outputs of each slave unit can be set in this mode.

1. Press the mode button repeatedly to set the master unit into the M mode (manual).

2. Press the zoom button repeatedly until <RATIO> is highlighted.

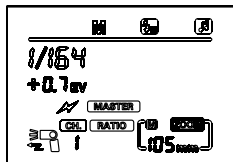

3. Select flash light ratio

Rotate the dial to set the flash ratio <RATIO>, <RATIO A:B> or <RATIO A B C>. Select the flash light ratio <RATIO> if you want to have on all slave unit the same brightness, exposure compensation and bracketing as the master flash. Select the flash light ratio <RATIO A B> to turn on the flash light of the groups A and B. Select the flash light ratio <RATIO A B C> to turn all slave unit groups on, the power brightness will be set by A and B and c will be the power output compensation.

Multi Wireless Master Mode (Command MASTER) (Canon)

Set the master flash into the multi mode. Different flash outputs of each slave unit can be set in this mode.

1. Press the mode button repeatedly to set the master unit into the Multi mode.

2. Press the zoom button repeatedly until <RATIO> is highlighted.

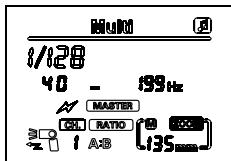

3. Select flash light ratio

Rotate the dial to set the flash ratio <RATIO>, <RATIO A:B> or <RATIO A B C>. Select the flash light ratio <RATIO> if you want to have on all slave unit the same brightness, exposure compensation and bracketing as the master flash. Select the flash light ratio <RATIO A B> to turn on the flash light of the groups A and B. Select the flash light ratio <RATIO A B C> to turn all slave unit groups on, the power brightness will be set by A and B and c will be the power output compensation.

4. Set the flash frequency

Press the middle button repeatedly until the flash frequency number is highlighted. Rotate the dial to set the value, which is available from 1 to 199 HZ. After the setting is done press the middle button again to confirm the value.

5. Set the number of flashes

Press the middle button repeatedly until the number of flashes is highlighted. Rotate the dial to set the value (1-40). If the flash ratio <RATIO OFF> is selected, the maximum of flashes is limited by the flash output power. If the flash ratio <RATIO A B> or <RATIO A B C> is selected, the maximum number of strokes is limited by the power output of group A.

Wireless Master Mode (command) (Canon)

6. Set flash output (<RATIO A:B>or<RATIO A:B:C>)

Press the middle button repeatedly until the frequency is highlighted and rotate the dial to change the value.

Press the middle button repeatedly until the number of flashes is highlighted and rotate the dial to change the value.

Press the middle button repeatedly until the group A is highlighted. Rotate the dial to adjust the power of group A.

Press the middle button repeatedly until the group B is highlighted. Rotate the dial to adjust the power of group B.

Press the middle button repeatedly until the group C is highlighted. Rotate the dial to adjust the power of group C.

Wireless Master Mode (command) (Nikon)

Wireless Master Mode (INSTRUCTION MODE MASTER) (Nikon)

Press the wireless option button repeatedly until the mode master is shown on the display.

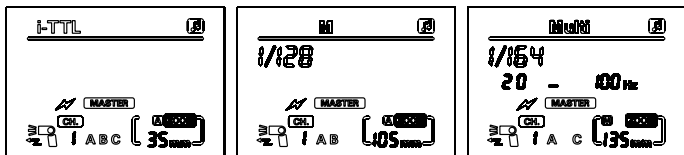

Wireless setting

To set the channel and other flash unit settings is the same as for the Canon master mode.

Set the master unit wireless channel

Press the zoom button until the channel number is highlighted on the display. Rotate the dial to set the value (1-4).

Set the master unit flash On / Off

You can turn the master function on and off.

Turn the master on: Press the zoom button until the icon \rightarrow is highlighted. Rotate the dial to turn it on. If the icon \rightarrow is shown on the display, the master function is turned off. If the icon \rightarrow is shown on the display, the master function is turned on.

Note: If a Nikon flash is the master unit you can freely set the mode and power of each slave unit group.

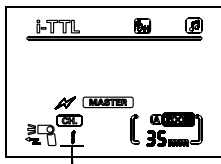

Wireless channel number

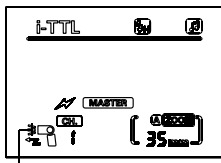

Master flash switch symbol

Wireless Master Mode (command) (Nikon)

Automatic wireless / manual master mode (INSTRUCTION MODE MASTER) (Nikon)

If the master unit is in TTL or M (manual) mode the slave unit supports the following modes: wireless off, TTL mode, M mode.

1. Press the mode button repeatedly until the display of the master flash is showing iTTL or M.
2. Each slave group mode setting.

Group A: Press the zoom button repeatedly until A and the mode is highlighted. Rotate the dial to change the mode of group A. After the setting is done, press the middle button to exit or to press the zoom button again to continue with the setting of group B.

Group B: Press the zoom button repeatedly until B and the mode is highlighted. Rotate the dial to change the mode of group B. After the setting is done, press the middle button to exit or to press the zoom button again to continue with the setting of group C.

Group C: Press the zoom button repeatedly until C and the mode is highlighted. Rotate the dial to change the mode of group C. After the setting is done, press the middle button to exit.

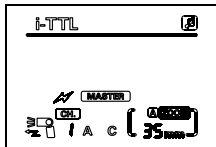
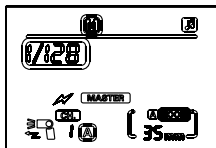
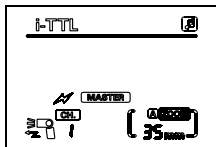

If the slave unit group setting is done, the groups that have a group mode will be shown on the display.

3. Each slave unit group power setting

Press the middle button repeatedly until group A is highlighted (assuming that for group A has been set a mode) to set the power. The setting will be done in the same way as described before for the group mode setting. After the setting is done, press the middle button to enter the next group.

Multi Wireless Master Mode (INSTRUCTION MODE MASTER) (Nikon)

If the master unit is in Multi mode the slave unit supports the multi mode or wireless off.

1. Press the mode button repeatedly until the display of the master flash is showing Multi.

2. Each slave group mode setting.

Group A: Press the zoom button repeatedly until A and the mode is highlighted. Rotate the dial to change the mode of group A. After the setting is done, press the middle button to exit or to press the zoom button again to continue with the setting of group B.

Group B: Press the zoom button repeatedly until B and the mode is highlighted. Rotate the dial to change the mode of group B. After the setting is done, press the middle button to exit or to press the zoom button again to continue with the setting of group C.

Group C: Press the zoom button repeatedly until C and the mode is highlighted. Rotate the dial to change the mode of group C. After the setting is done, press the middle button to exit.

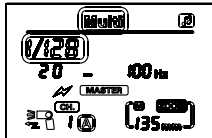
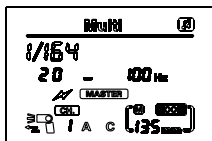

If the slave unit group setting is done, the groups that have a group mode will be shown on the display.

Wireless Master Mode (command) (Nikon)

3. Set the flash frequency

Press the middle button repeatedly until the flash frequency number is highlighted. Rotate the dial to set the value, which is available from 1 to 100 HZ. After the setting is done press the middle button again to confirm the value.

4. Set the number of flashes

Press the middle button repeatedly until the number of flashes is highlighted. Rotate the dial to set the value (1-40).

5. Set flashing power

If nothing is highlighted on the display, rotate the dial to set the flash power.

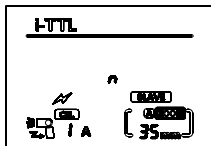
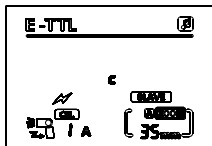

Slave C: This mode indicates that the wireless flash signal can only be received from the internal flash of the Canon 7D/60D/600D and the flashes 580II, 600EX as well as ST-E2.

Slave N: This mode indicates that the wireless flash signal can be received from the built-in Nikon flashes and the flashes SB-900/800/700 and SU-800.

Slave C/N: This mode supports 4 channels, 3 groups, TTL, manual and multi mode. Rotate the flash light head in the direction of the wireless master unit. Before the shooting you need to ensure that the slave units have the same channel as the master light. Repeatedly press the zoom button until the channel or group is highlighted and set the value of each.

When working on the slave unit, please note that the flash brightness and the mode are completely controlled by the master unit and on the slave unit's display only the received information is displayed.

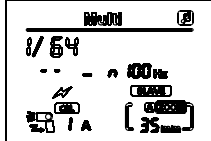
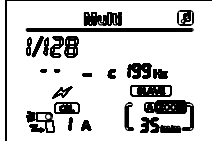
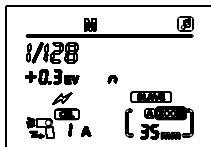
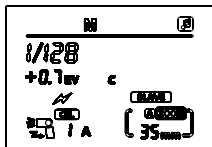

Light Sensing Mode

Light Sensing Mode (S1 / S2)

When using S1 / S2 mode, you need to turn the flash head so that the sensor is facing the master flash.

Press the wireless option button repeatedly until the display is showing S1 / S2 mode. These modes are suitable for manual flash environment and TTL flash environment.

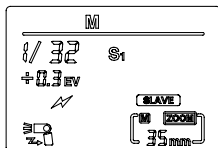

S1 Mode

It will work with the first trigger of the master flash synchronously. The master flash should be set into manual mode.

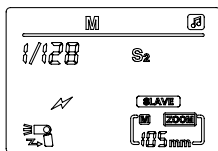

S2 Mode

It is also called pre-flash cancel mode. It can neglect the pre-flash given by TTL flash and therefore it can support the main flash working in TTL mode.

Note: If the slave flash does not sync flash with the master flash light in S1 / S2 mode, please set the optical mode of the slave light and the power output correctly.

Please avoid the following situations mentioned below:

1. Avoid master light to use red eye reduction function
2. Avoid master light to use instruction mode (Nikon) or wireless mode (Canon)
3. Avoid master light to use ST-E2

Note: When the flash is in S1 or S2 mode, you can not change the mode by pressing the mode button. You need to leave the S1 or S2 mode.

1. 2.4G Light Applications

You can create multiple subordinate unit groups to complete the multi-directional shooting needs. This unit is not directional, casually shooting in any corner can be cited flash. The following modes can be set by the master unit: TTL, flash ratio, manual flash output, strobe and so on.

1. Wireless flash that consists of two slave unit groups

Set wireless options: SLAVE (2.4G)

Set the communication channel: 1 ~ 16

Set up grouping: Set one flash as group A and the other as group B.

Set the main control unit: Set the communication channel: set the flash unit ratio A: B or A: B: C, you can shoot flash (in Canon as an example)

2. This unit consists of three slave groups

Set wireless options: SLAVE (2.4G)

Set the communication channel: 1 ~ 16

Set the grouping: Set the three flash units to A, B, and C groups respectively

Set up the main unit and shoot

Set the communication channel: Set the flash ratio of the main control unit to <A: B: C> (for Canon example)

Press the test button on the master unit to check whether the flash is normal:

If the slave unit is not flashing, check the communication channel and group of the flash. They need to be all the same.

Note: If the ratio <RATIO A: B> is set, the flash of group C will not fire.

If the group of three flash light is set <A>, they will be controlled by the MASTER flash light.

2. Light Transmission Application

You can create multiple subordinate unit groups to complete the multi-directional shooting needs. This unit is not directional, casually shooting in any corner can be cited flash. The following modes can be set by the master unit: TTL, flash ratio, manual flash output, strobe and so on.

1. Wireless flash that consists of two slave unit groups

Wireless option setting: Choose slave Canon or slave Nikon

Communication channel: 1,2,3,4

Group setting : Set one light as group A and the other light as group B.

Master unit setting :Set the communication channel: set the flash unit ratio

A: B or A: B: C, you can shoot flash (in Canon instruction as an example)

2. This unit consists of three slave groups

Wireless option setting: SLAVE CANON, SLAVE NIKON

Communication channel: 1,2,3,4

Group setting : Set the three flash units to A, B, and C groups respectively

Set up the main unit and shoot

Set the communication channel: Set the flash ratio of the main control unit to

<A: B: C> (for Canon example)

Press the test button on the master unit to check whether the flash is normal:

If the slave unit is not flashing, check the flash unit's angle to the master flash and its position to the main unit distance.

Note: If the ratio <RATIO A: B> is set, the flash of group C will not fire.

If the group of three flash light is set <A>, they will be controlled by the MASTER flash light.

3. Wireless light-sensing application (S1 / S2)

Use the built-in flash or the set-top external flash as the master flash. Place the flash in a variety of directions.

In indoor use the wireless optical signal can be reflected back through the wall. So maybe more space is needed.

Due to a higher sensor sensitivity the wireless trigger sensing does have a distance of up to 15 meters when using the S1 or S2 mode outside.

If a slave Flash Unit is used, test the S1 or S2 mode whether it is synchronous before shooting. Don't put any barriers between the master and slave Flash Unit. The barrier will prevent to send a wireless light signal.

Make sure that the optic control sensor is towards to the master Flash Unit. The Flash Unit should not be used under sunshine.

Multi Lighting Applications

Automatic Save Function

After the flash has been set up and for about 5 seconds no buttons are pressed, the flash will automatically save the current settings. It is convenient for next time operation.

Reset All setting to factory default settings

When you need to restore the factory default settings, simply press the wireless option button & high-speed sync button at the same time, and the flash restores the default setting.

*Press both at the same time.

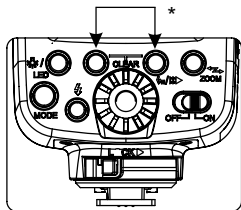

Flash lock (low Power Tips)

If the battery power is low or the flash cannot recycle due to any other reasons within a determined time, the flash will enter the locked status.

The screen of the flash will show the signs like shown in the picture below and the buzzer will ring five short beeps. This should remind the user

that the battery needs to be replaced in order to ensure a normal use. If the battery is replaced but the flash keeps in the locked status, please contact our customer service.

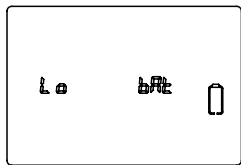

Setting Position and Operation range

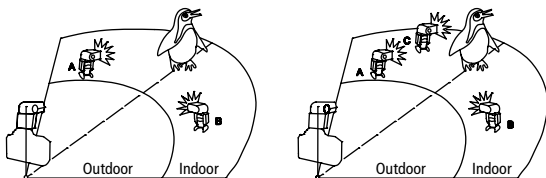

Using the Built-In Reflecting Card

The built-in reflecting card ensures that the subject will be brighter, sharper and it avoids a direct lighting in front of the subject.

- 1.) Rotate the flash head of up to 90 degrees.
- 2.) Pull out the wide panel and reflecting card.
- 3.) Pull in the wide panel and only leave the reflecting card outside.

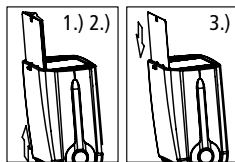
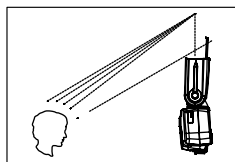

Multi Lighting Applications

Bounce Flash

If the flash head is pointed to the wall or ceiling, the flash will be reflected by the wall. If this is illuminating then the subject, this can help to reduce shadows around the subject and get more natural effects.

Adjust the flash head tilt, rotation angel and select the reflection plane

If the Flash Units' head is pitched up so that the ceiling is used as a reflection plane, this can have a good effect.

Please pay attention: Don't let the Flash Unit head directly shine to the body of a person.

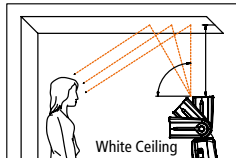

The effective distance between the Flash Unit head and the reflection plane should be about 1 m to 2 m. If colour photos are taken, please choose a white or strong reflection for flashing.

Use the Built-In Wide Angel Diffuser

This is used if you want to have a wider flash light (flare light).

1. Pull out wide diffusion plate

Slowly pull completely out the wide diffusion plate.

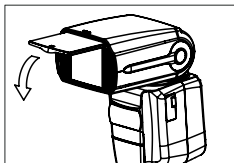

2. Push the reflector plate

Then push the reflector plate back again into the flash head.

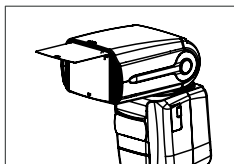

Using the Diffuser:

Attach the diffuser on the Flash Unit. The light will be softer which will help to get no shadow. This can be used in landscape as well as portrait format. The best effect can be achieved if the Flash Unit head has a position of 60 degrees.

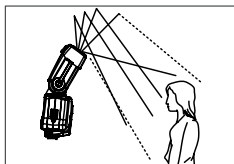
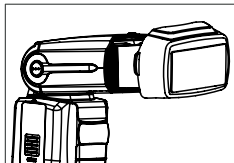

Voice Prompts

Different sounds are used to indicate different working conditions.

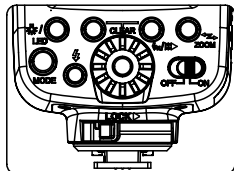
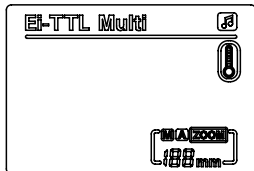

Press the customize menu settings button for a longer time to enter the customer settings. The signal tones can be switched ON or OFF.

1. A long ring: call back to complete
2. Two short rings: on or call back to complete normal flash.
3. Two long rings: flash call back unfinished.
4. Five short rings: the battery power is not enough or call back timeout.
5. Continuous buzz: flash light overheating and come into overheating protection.
The display will show the icon.

Backlight display

1. ON/OFF: Press the backlight button to turn it on or off.
2. If the flash is not used for about 15 seconds the backlight will automatically turn off.

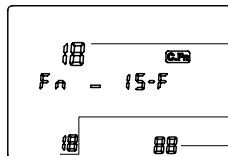
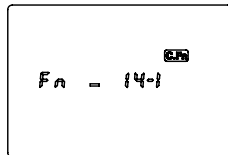
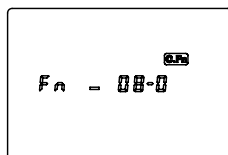
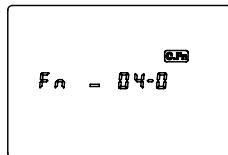
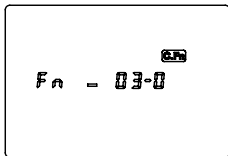
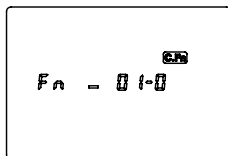

Firmware version year

Firmware version month

Firmware version date

You can customize the flash function according to your needs. Therefore, press the zoom button for a longer time and the display will show the parameter settings as shown above. Press the middle button to select the settings that you need to be changed. Rotate the dial to set them on or off. Then press the mode button to exit the menu.

Custom Menu Setting

Custom function No	Function	Setting No	Settings and instructions
Fn-01	Auto Sleep	0	On
		1	Off
Fn-03	Auto cancel flash exposure	0	On
		1	Off
Fn-04	Flash exposure order	0	0 → - → +
		1	- → 0 → +
Fn-08	Auto focus assistant flash	0	On
		1	Off
Fn-14	Buzzer Switch	0	On
		1	Off
Fn-15	System version information	F	Firmware date

Note: FN number of 00 ~ 13 options can be accessed through the camera menu of "External flash custom function settings". The numbers for 00, 02, 05, 06, 07, 09, 10, 11, 12, 13 option has been disabled. (Internal Canon camera menu).



Dispose of packaging: For disposal, separate packaging into different types. Cardboard and board must be disposed of as paper and foil must be recycled.



Disposal of Waste Electrical and Electronic Equipment and/or Battery by users in private households in the European Union.



This symbol on the product or on the packaging indicates that this cannot be disposed of as a household waste. You must dispose of your



waste equipment and/or battery by handing it over to the applicable take-back scheme for the recycling of electrical and electronic equipment and/or battery. For more information about recycling of this equipment

and/or battery, please contact your city office, the shop where you purchased the equipment or your household waste disposal service. The recycling of materials will help to conserve natural resources and ensure that it is recycled in a manner that protects human health and environment.

Battery Warning

- Never dismantle, crush, or pierce the battery, or allow the battery to short-circuit. Do not expose battery being placed in high temperature environment, if battery leaks or bulges, stop continue to use.
- Always charge using the charger. Risk of explosion if battery is replaced by an incorrect type.
- Keep the battery out of reach of children.
- Batteries may explode if exposed to naked fire. Never dispose of batteries in a fire.
- Disposed of used batteries observing local regulations.
- Before disposing the device, please remove the battery.

The Manufacturer hereby declares that the CE marking was applied to the Rollei Flash Unit 58F in accordance with the basic requirements and other relevant provisions of the following CE Directives:

2011/65/EC RoHs Directive
2014/30/EU EMC Directive
2006/95/EEC LVD Directive
2009/125/EG EuP Directive
2002/96/EG WEEE Directive
2014/53/EU RED Directive



The EC Declaration of Conformity can be requested from the address specified on the Warranty card.