

Contents

About this guide	4
Prohibition of co-location	4
WEEE notice.....	4
CE regulatory notice	5
Battery warning.....	5
Caution	6
Important information regarding the waterproofing of the camera.....	8
Important information regarding the property of the Underwater Case (optional)	10
1 Introduction	11
1.1 System requirements	11
1.1.1 Connection to a Computer.....	11
1.1.2 Linking a mobile device	12
1.2 Features	12
1.3 Package contents.....	13
1.4 Product overview.....	14
1.5 Button operation.....	15
2 Getting started	16
2.1 Inserting the memory card	16
2.2 Charging the device	17
2.2.1 Charging from a computer and an outlet	17
2.3 Definition of indicator lights	18
2.4 Information in LCM screen	19

2.5	Installing with a mount.....	21
2.5.1	Installing the clip mount & strap.....	21
2.5.2	Installing the tripod mount	21
2.5.3	Installing the desktop mount.....	22
2.5.4	Installing the head mount/ camera (option) ..	22
2.5.5	Using the Underwater case (option)	23
3	Initial set up.....	24
3.1	Camera application installation	24
3.2	Wi-Fi connecting	25
4	Using the Rollei Add Eye Cam application.....	26
4.1	Recording videos	26
4.1.1	The Video screen.....	27
4.2	Photographic Image	29
4.2.1	The Photo screen	30
4.3	Timelapse videos	32
4.3.1	The Timelapse screen	34
4.4	Playback pictures and videos	36
4.4.1	Viewing pictures.....	37
4.4.2	Playing videos	38
5	Settings menu	40
5.1	Using the settings.....	40
5.1.1	Menu items	41
6	Connecting to other devices	43
6.1	Connecting to the computer	43
7	Installing the software.....	44

8	Editing software	45
9	Specifications	46
10	License Statement	48

About this guide

The content in this document is for information purposes and is subject to change without prior notice. We have made every effort to ensure that this User Guide is accurate and complete.

However, no liability is assumed for any errors or omissions that may have occurred.

The manufacturer reserves the right to change the technical specifications without prior notice.

Prohibition of co-location

This device and its antenna(s) must not be co-located or operated in conjunction with any other antenna or transmitter.

WEEE notice

Disposal of Waste Electrical and Electronic Equipment and/or Battery by users in private households in the European Union



This symbol on the product or on the packaging indicates that this can not be disposed of as household waste. You must dispose of your waste equipment and/or battery by handling it over to the applicable take-back scheme for the recycling of electrical and electronic equipment and/or batteries. For more information about the recycling of this equipment and/or battery, please contact your city office, the shop where you purchased the equipment or your household waste disposal service. The recycling of materials will help to conserve natural resources and ensure that it is recycled in a manner that protects human health and the environment.

CE regulatory notice

Herewith confirm to comply with the requirements set out in the Council Directives on the approximation of the Laws of the Member States relating Electromagnetic Compatibility of Radio and Telecom device (1995/5/EC); the Low Voltage Directive (2006/95/EC); the Restriction of The Use of Certain Hazardous Substances in Electrical And Electronic Equipment Directive (2002/95/EC), Turkish EEE Directive; the Commission Regulation (EC) No 1275/2008 implementing Directive 2005/32/EC of the European Parliament and of the Council with regard to eco-design requirements for standby and off mode electric power consumption of electrical and electronic household and office equipment, and the Directive 2009/125/EC of the European parliament and of the council establishing a framework for the setting of eco-design requirements for energy-related products.

Battery warning

- ❖ Always charge using the provided system. Improper handling of the battery may result in explosion.
- ❖ Never dismantle or pierce the battery or allow the battery to short-circuit.
- ❖ Keep the battery out of reach of children.
- ❖ Batteries may explode if exposed to naked fire. Never dispose of batteries in a fire.
- ❖ Disposed of used batteries observing local regulations. Never replace the battery on your own; have the dealer do it for you.

Caution

- ❖ Never disassemble the device or remove any parts by yourself. This will invalidate all guarantee claims.
- ❖ Keep the device away from the reach of children or animals to prevent them from swallowing.
- ❖ If you notice smoke or a strange smell coming from the device, turn the power off immediately. Take the device to the nearest authorized service center for repair. Never attempt to repair the device on your own.
- ❖ Use only the recommended power accessories. Use of power sources not expressly recommended for this equipment may lead to overheating, distortion of the equipment, fire, electrical shock or other hazards.
- ❖ Wi-Fi Signals are unable to pass through the building. The upper limit of signal transmission is 10m.
- ❖ Wi-Fi Operation Channels List: Ch1~Ch11.
- ❖ The product employs wireless data communication which may interfere, or be interfered by, a near-by device.
- ❖ Never use this device in the vicinity of a microwave oven or at places where there is radio interference.
- ❖ Radio wave reception may be worsened in specific environments.
- ❖ Please be advised that if another device is also using the same 2.4GHz band as this product, the processing speed of both devices may slow down.
- ❖ This product gets warm when in use; this is normal.
- ❖ Improper use or operation of the product may result in damage of the product or its accessories and void the warranty.
- ❖ The radio frequency (RF) generated by this RF electronic device may cause adverse effects on the operation of other electronic devices and result in malfunctioning. Wireless transmitters and circuitry may also interfere with other

electronic devices. Therefore, do observe the following precautions:

- Aircraft: Never use a radio transmitter when you are in an airplane. Please switch off the Wi-Fi function of the device.
 - Vehicle: The radio frequency transmitted by this device may affect the electronic system in a motorized vehicle. Please consult the manufacturer or dealer of your vehicle on the possible effect.
 - Pacemaker: In order to prevent any potential interference to a pacemaker, anyone who uses a pacemaker should be advised, that, when using this device, a minimum distance of 15cm (6 inch) should be kept between the device and the pacemaker; and never put this device in a chest pocket. In case of any doubt of interference, switch off the device immediately.
 - Medical Device: If you use a personal medical device, consult the device manufacturer or your physician to confirm if your device is sufficiently shielded from the RF transmission of this device.
 - Medical Facilities: Hospitals and medical institutes may use facilities that are sensitive to an external RF energy. Observe such instructions when the medical care personnel or any posted sign requests you to switch off any device that may interfere the radio frequency.
 - Explosion sites or any location with a posted sign: In order to prevent interfering with an explosion activity, observe all the signage and instructions in the Explosion Area or in a zone with a “Switch Off 2-way Radios” sign by switching off devices that may interfere with the radio frequency.
- ❖ This product is unsuitable for filming any barcode.
 - ❖ The camera has become too hot and needs to cool down after using over than 1 hour (continuous recording). Simply shut down for cooling before attempting to use it again. It won't damage the camera, it is only for reminding the user that the temperature of the camera is too high.

Important information regarding the waterproofing of the camera

This product complies with Class V of IEC waterproof classification (IPX5), being capable of sustaining low-pressure water jets in all directions, and possesses waterproof properties for normal activities.

Precautions prior to using the device:

- ❖ Make sure that no foreign objects, sand or dust are attached to the waterproof cover of the USB/memory card slot. If foreign an object has become attached, remove it carefully with a lint-free cloth.
- ❖ Make sure that there is no crack or damage on the waterproof cover of the USB / Memory card slot.
- ❖ Verify carefully that the waterproof cover of the USB / Memory card slot is sealed tightly; make sure the cover is not open in a wet situation.
- ❖ Do not open/close the waterproof cover of the USB / Memory card slot with a wet hand, otherwise electric shock or device malfunction may occur.
- ❖ The product is only waterproof for activities encountered during normal living; DO NOT immerse the product into water. In the event of accidental soaking or ingression of water, switch off the power immediately and bring the product to a nearby authorized service center for repair.
- ❖ Avoid allowing the product to come into contact with any chemicals or liquids.
- ❖ Internal moisture caused by human error will result in a voided warranty.
- ❖ The product is only suitable for use within the temperature range: -10° ~ 50° C (14° ~ 122° F) and humidity range: 0 ~ 95% RH].

Precautions after use:

- ❖ In the event of water staining on the product, clean the product carefully using a lint-free cloth; make sure the product is fully dry before opening the waterproof cover of the USB / Memory card slot.
- ❖ If water clings to the internal side of the waterproof cover of the USB / Memory card slot of the device, dry it fully before using the device.

Storage and maintenance:

- ❖ Store the product in an environment of temperature range: -20° ~ 60° C (-4° ~ 140° F) and humidity range: 0 ~ 90% RH] only.
- ❖ Never use any chemicals on the product for cleaning, anti-rust, anti-fog, etc., or the waterproof capability may deteriorate.
- ❖ Make sure the waterproof cover of the USB / Memory card slot is sealed tightly before rinsing the stain with low-pressure running water, followed by wiping dry with a lint-free cloth or leave it to air-dry.
- ❖ To ensure the waterproof capability of the product, it is suggested that you should replace the waterproof cover of the USB / Memory card slot of the device on a yearly basis.
- ❖ Take heed to prevent any impact of the product, otherwise the casing or lens may become damaged, or the waterproof capability may be eroded.

Important information regarding the property of the Underwater Case (optional)

The exclusive waterproof casing (optional) for the product complies with IEC Class VIII (IPX8) specification, which allows immersing the product at a depth of 10m of water for up to 30 minutes when having installed the Camera inside the casing.

Precautions for underwater operation:

- ❖ Never use the product at a depth exceeding 10m in the water; never use the product under water for more than 30 minutes.
- ❖ NEVER open the waterproof casing when the device is submerged in water.
- ❖ Never jump into the water with the waterproof casing impacting the surface of the water. An excessive impact force may cause water ingress.

Failure to follow the above each time you use the camera can result in leaks that may damage or destroy your camera. Your warranty does not cover water damage resulting from user error.

Before you start using the system, it is assumed that you agree to the above statement. The warranty does not cover any damage that may occur during a sport activity. It is the users' responsibility to secure the camera securely.

1 Introduction

Thank you for purchasing this camera. This device is specifically designed for real time video and audio recording during leisure activities.

1.1 System requirements

1.1.1 Connection to a Computer

For connection to a PC, be sure your PC meets the following specifications:

For Windows:

- Windows XP SP2 / Vista / Win 7 / Win 8
- Processor with at least Pentium IV 3.2GHz / AMD Athlon FX 2.6GHz or higher
- 2GB RAM at least
- NVIDIA GeForce 7600GT / ATI X1600 series or later
- USB port
- 16-bit color display compatible monitor (1280x1024, 32-bit color display recommended)
- 250 MB of available hard disk space
- CD-ROM drive

For Macintosh:

- Mac OS 10.4 or higher
- Power Mac G3 or higher
- Minimum 256MB RAM
- 110MB of available hard disk space
- USB port
- CD-ROM drive

1.1.2 Linking a mobile device

Linking a mobile device, be sure your mobile device meets the following specifications:

For iOS operating system:

- Version: 6 / 7
- Product Name: iPhone4S / iPhone5 / iPhone5S / iPad / iPad2 / New iPad (Retina display) / iPad Air

For Android operating system:

- Version: 4
- Brand Name: HTC / SONY / SAMSUNG / LG
- Screen Resolution: MDPI / HDPI

1.2 Features

- Excellent 8MP CMOS sensor
- Full HD camcorder (1920x1080 @30fps)
- Wi-Fi Built-in
- 4K MJPEG Time-Lapse video
- Complies with Class V of IEC waterproof classification (IPX5)
- The exclusive waterproof casing (optional) for the product complies with IEC Class VIII (IPX8) specification
- Real-time live video preview via mobile device (iOS / Android App)
- Self-timer function supported
- Support App / PC Edit Software

1.3 Package contents

The package contains the following items. In case there are any missing or damaged items, contact your dealer immediately.

Camera



Clip mount



Strap



Micro USB
cable



CD-ROM



Quick start
guide



Tripod
mount



Desktop
mount



Head mount
(Option)



Underwater
case (Option)



1.4 Product overview

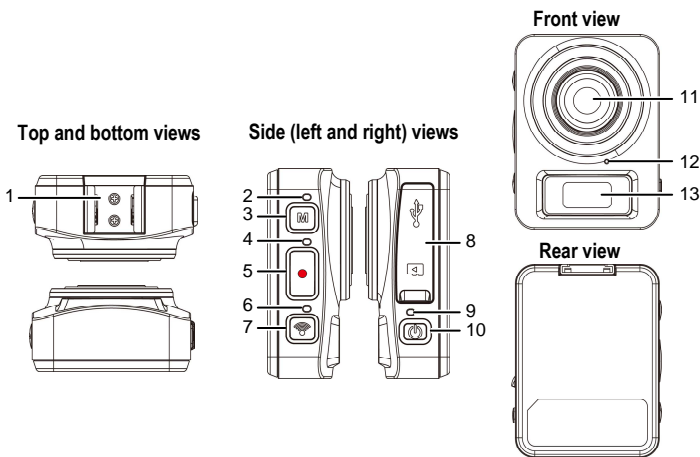

No.	Item
1	Bracket socket
2	Mode indicator light
3	Mode button
4	Timelapse / Photo / Video indicator light
5	Record Button
6	Wi-Fi indicator light
7	Wi-Fi button

No.	Item
8	Waterproof cover of the USB / Memory card slot
9	Power indicator light
10	Power button
11	Lens
12	Microphone
13	LCM screen

1.5 Button operation

You can operate the camera alone without connecting to a mobile device via Wi-Fi/App. See the table below for a description of each button's function.

Item	Function
Mode button	Changing Modes (Timelapse / Camera / Video mode)
Record button	<ul style="list-style-type: none">• In Timelapse mode, press the Record button to start recording a video. Press it again to stop recording (When the device enters Power Saving Mode and is in shutdown status, press the Power button to stop recording).• In Camera mode, press the Record button to capture a photo.• In Video mode, press the Record button to start recording a video. Press it again to stop recording.
Wi-Fi button	<ul style="list-style-type: none">• Press to turn the Wi-Fi on or off.
Power button	<ul style="list-style-type: none">• Press to turn the camera on or off.• To reset, press and hold the Power button for at least 5 seconds.

Note:

If you want the recorder to go back to the **Default Setting**, make sure the camera's Wi-Fi is turned off. Press and on-hold the **Mode** button, then press the **Wi-Fi** button, when the beep tone is promoted, which indicates the completion of factory settings.

2 Getting started

2.1 Inserting the memory card

1. Open the waterproof cover of the USB / Memory card slot.
2. Insert the memory card with the gold contacts facing the front of the device. Push the memory card until it clicks into place.

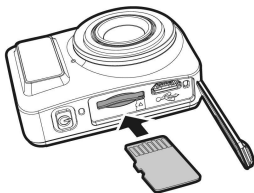

3. Make sure the waterproof cover of the USB / Memory card slot is sealed tightly, to achieve normal activity waterproofing.

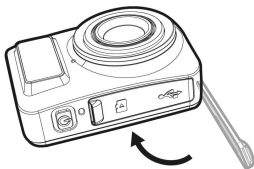

4. To remove the memory card, push to eject the memory card out of the slot.

Note:

1. Do not remove or insert the memory card when the device is turned on. This may damage the device and memory card.
2. Please use a Class 10 or higher rating Micro SD card, max up to 32GB.
3. Please format the micro SD card before initial use.

2.2 Charging the device

2.2.1 Charging from a computer and an outlet

1. Open the waterproof cover of the USB / Memory card slot.
2. Connect the micro USB cable into the port on the device.
3. Connect the other end of the micro USB cable to an available USB port on your computer.

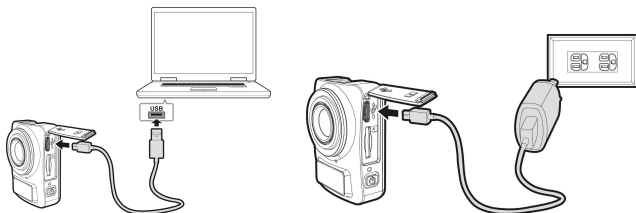

4. On completion of charging, make sure the waterproof cover of the USB / Memory card slot is sealed tightly, to achieve normal activity waterproofing.



Note:

1. Please take note if the environment temperature reaches 45°C or above, the wall outlet can still supply power to device, but it will not charge the Lithium-ion battery. This is the characteristic of Lithium-ion and is not a malfunction.
2. If the Wi-Fi function is not enabled, the device can sustain an operation of about 1 hour.
3. If you turn on the device while charging, this will slow charge.

2.3 Definition of indicator lights

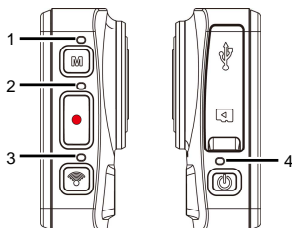



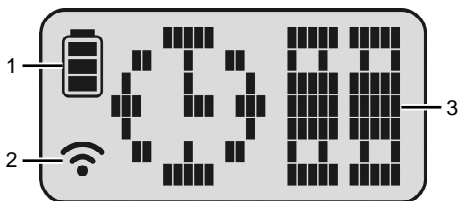

No.	Item	Status	LED indicator	Sound effect
1	Mode indicator light	Changing modes	Flash red	One beep
		Self-timer	Flash red	None
		Timelapse mode	Flash red	None
2	Timelapse / Photo / Video indicator light	Timelapse	Flash red	One beep (Time interval)
		Camera	Flash red	One beep
		Video	Flash red	One beep
3	Wi-Fi indicator light	Wi-Fi on	Red	One beep
		Wi-Fi off	No indication	One beep
4	Power indicator light	Power on	Red	None
		Power off	No indication	None
		Power will soon be out	Flash Red	None
		Charging	Red	None
		Fully charged	No indication	None

2.4 Information in LCM screen



No.	Item	Icon	Description
1	Battery status		Full battery power
			2/3 battery power
			1/3 battery power
			Out of battery power
			Charging
2	Wi-Fi status		Wi-Fi on
			Wi-Fi off
3	Status		Timelapse mode
			Camera mode
			Video mode
			Memory card error (damaged, locked or no card inside)

			Memory card full
			Connect with mobile
			Enter USB mode when connected with a computer
			Power will soon run out

2.5 Installing with a mount

2.5.1 Installing the clip mount & strap

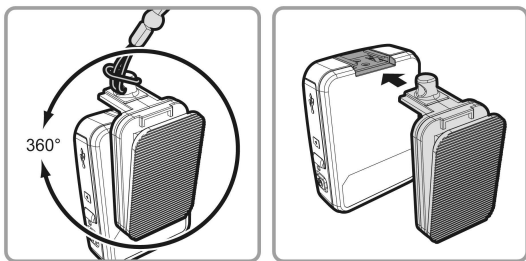

2.5.2 Installing the tripod mount

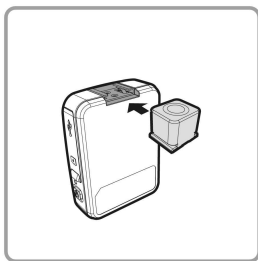

2.5.3 Installing the desktop mount

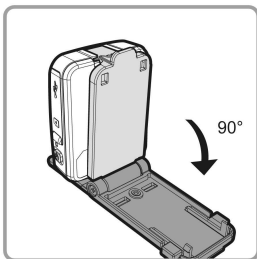
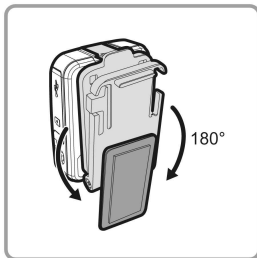

2.5.4 Installing the head mount/ camera (option)

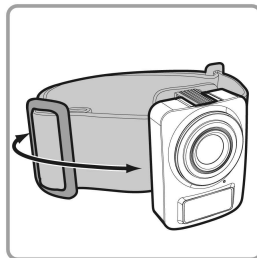
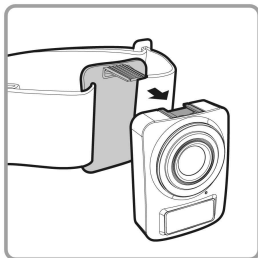

2.5.5 Using the Underwater case (option)



3 Initial set up

Install a micro SD card (class 10 or higher rating, max up to 32GB) into the camera device.

3.1 Camera application installation

The camera allows you to connect to the mobile devices via the App. When using for the first time, install the [Rollei Add Eye Cam] App for your mobile device.

1. Download **Rollei Add Eye Cam**  App from Google Play or IOS App Store.

APP Layout and Features may be changed subject to different software versions. Please refer to Google Play or APP Store for update.

3.2 Wi-Fi connecting

1. Press the **Power** button to switch on the camera.
2. Press the **Wi-Fi** button to activate the wireless network.
3. Using the Wi-Fi function of the mobile device, search for the equipment ID from the list. Each device has a unique ID no.: RolleiAddEyeCamXXXXXX (if the last 2 digits are the same as the last 2 digits of your password, your device corresponds.)
4. Select and input Wi-Fi password (repeating the 4 numeral/letter on your LCM display twice will give you the Wi-Fi password. E.g., if LCM display shows “1234”, you Wi-Fi password will be 12341234.

For iOS / Android Users:

Using the mobile device [Settings] → [Wi-Fi] → [Select device ID no.: RolleiAddEyeCamXXXXXX] → [Enter the password] → [Connecting]

5. Execute the **Rollei Add Eye Cam App**  , the device LCM display will show **APP** , indicating the connection is established.





Note:

1. Make sure the Wi-Fi function of the camera is activated and the mobile device is receiving Wi-Fi signal before executing the Rollei Add Eye Cam App, or the App will be exited.
2. The mobile device shall be within a maximum of a 10m distance from the equipment without any buildings in between.
3. When the Wi-Fi function of the camera is activated for 3 minutes without connecting to your mobile device, or the connection is disconnected, the camera will automatically stop the Wi-Fi function and you will need to re-activate the Wi-Fi function.
4. We suggest that you should set the correct date and time to your mobile device before using the camera, so that the recorded video will be consistent with the date and time settings of the mobile device.
5. After connecting the mobile device with the equipment, all the mode switch, **Record** and **Wi-Fi** operation buttons of the equipment will be inoperable; all the operations shall be carried out via the Rollei Add Eye Cam App.
6. The language of the Rollei Add Eye Cam App will be consistent with your mobile device, it shall be the default language.

4 Using the Rollei Add Eye Cam application

4.1 Recording videos

You can use this feature to record your life story, travel diary, or sports clips.





1. Touch the  button to switch over to Video mode.
2. Touch the  button to set video duration. (3 min. / 5 min. / 10 min. / 30 min.)
3. Touch the  button to enable or disable Voice Record.
4. Press  button to start recording a video.
5. Press  button again to stop recording.



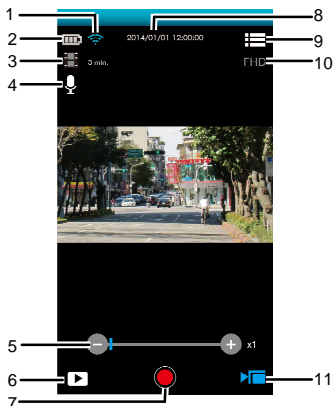





Note:

Prior to recording video, you may set **Rotate View** to alter the viewing angle of the recorded video.

4.1.1 The Video screen



No.	Icon	Item	Description
1		Wi-Fi status	Indicates the Wi-Fi status.
2		Battery status	Indicates the remaining battery power.
3		Video duration	The device will follow the set recording video length to store them as individual files. Touch to select the required video duration. Available options: 3 min. / 5 min. / 10 min. / 30 min.
4		Voice record	Touch to select the required voice record setting. Available options: On / Off





No.	Icon	Item	Description
5		Zoom indicator	Indicates the zoom status. Touch  /  to adjust the zoom. Available options: x1.0~x2.4
6		Playback	Touch to enter Playback mode.
7		Recording	Touch  to start recording, and touch  again to stop.
8	2014/01/01 12:00:00	Date and time	Indicates the current recording date and time.
9		Menu	Touch to enter the menu.
10	FHD	Video resolution	Indicates the current video resolution.
11		Video mode	Indicates the current Video mode. Touch to switch to Timelapse or Photo mode.

Note:

If download the AVI format videos to the iOS system mobile device, the device can't recognize the AVI files format rather than lost. To browse files please use a computer or other media players.

4.2 Photographic Image

You can use this feature to take photos, such as landscape and portraits.





1. Touch the  button to switch-over to Shooting mode.
2. Touch the  button to set Self Timer and sequential (Burst) capture. (Normal / 5 sec. / 10 sec. / Burst 3 Photos / Burst 5 Photos).
3. Touch the  button to set Beauty class. (0 / 1 / 2).
4. Touch  to take the image, the file will be saved on the camera device automatically.



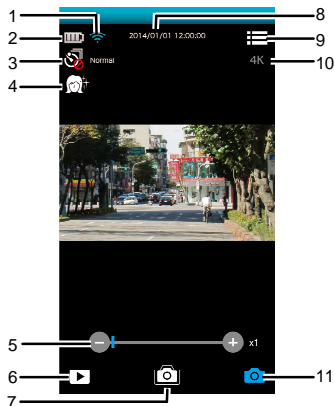



Note:

1. When using the **Beauty** function, the algorithm takes about 8 seconds; you need to wait patiently.
2. Prior to taking a picture, you may set **Rotate View** to alter the viewing angle of the recorded picture.

4.2.1 The Photo screen







No.	Icon	Item	Description
1		Wi-Fi status	Indicates the Wi-Fi status.
2		Battery status	Indicates the remaining battery power.
3		Photo mode	Touch to select the need photo mode. Available options: Normal / 5 sec. / 10 sec. / Burst 3 Photos / Burst 5 Photos
4		Beauty	Touch to select the required Beauty mode. Available options: 0 / 1 / 2





No.	Icon	Item	Description
5		Zoom indicator	Indicates the zoom status. Touch  /  to adjust the zoom. Available options: x1.0~x2.4
6		Playback	Touch to enter Playback mode.
7		Photo	Touch to start taking photos.
8	2014/01/01 12:00:00	Date and time	Indicates the current recording date and time.
9		Menu	Touch to enter the menu.
10	4K	Photo resolution	Indicates the current photo resolution.
11		Photo mode	Indicates the current Photo mode. Touch to switch to Timelapse or Video mode.

4.3 Timelapse videos

Stringing images together as a series of moments can capture change over time. This technique is called **Timelapse** photography.

You can use this feature to record videos such as the evolution of a construction project, weather changes, the rising from the sun, or flower blossom.

1. Touch the  button to switch over to Timelapse mode.
2. Touch the  button to set time interval of the Timelapse mode in (5 sec. / 10 sec. / 30 sec. / 1 min. / 5 min. / 10 min. / 30 min.).
3. Touch the  button to set the file format of Timelapse video files.
 - Picture: to save in picture files (Format: JPG).
 - Video: to save in video files (Format: AVI / MOV).
 - Picture / Video: to save in picture and video files (Format: JPG; AVI / MOV).
4. Touch the  button to set the desired frame rate of the Timelapse mode (i.e. frames per second for picture playback).
 - 3 fps: displays 3 frames per second.
 - 5 fps: displays 5 frames per second.
 - 10 fps: displays 10 frames per second.





5. Touch the  button to set the power saving mode.
 - Activate power saving mode: the equipment powers on only at intervals to take a picture (i.e. the equipment is powered off between intervals. When you touch , the equipment will automatically disable Wi-Fi and exit the Rollei Add Eye Cam App).
 - Deactivate power saving mode: the equipment is continuously in standby.
6. Touch  to start taking photos, the file will be saved automatically on the camera device.
7. Touch  again to stop.

Note:

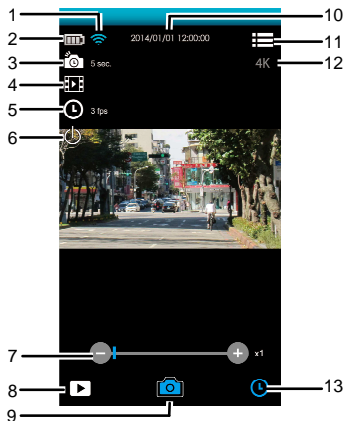
1. The setting of **Timelapse** is an approximate time with a tolerance of about 1s.
2. **Timelapse** function stops when the memory is fully used or equipment is out of power. It is suggested that you calculate the number of pictures in advance or activate power saving mode before starting Timelapse operation.
3. When the **Timelapse** interval setting is less than 10s, the power saving mode cannot be enabled.
4. When playing video footage recorded in **Timelapse** mode, the playback speed (picture per second) will be in accordance with the frame rate setting.
5. Prior to recording, you may set **Rotate View** to alter the viewing angle of the recorded picture or video.

4.3.1 The Timelapse screen





No.	Icon	Item	Description
1		Wi-Fi status	Indicates the Wi-Fi status.
2		Battery status	Indicates the remaining battery power.
3		Timelapse	Touch to select a suitable Interval. Available options: 5 sec. / 10 sec. / 30 sec. / 1 min. / 5 min. / 10 min. / 30 min.
4		File Format	Touch to select the required storage type. Available options: Picture / Video / Picture & Video

No.	Icon	Item	Description
5		Frame rate	Touch to select the required frame rate. Available options: 3 fps / 5 fps / 10 fps
6		Power saving mode	Touch to select the power saving mode. Available options: On / Off
7		Zoom indicator	Indicates the zoom status. Touch / to adjust the zoom. Available options: x1.0~x2.4
8		Playback	Touch to enter Playback mode.
9		Camera	Touch to start shooting photos and touch again to stop.
10	2014/01/01 12:00:00	Date and time	Indicates the current recording date and time.
11		Menu	Touch to enter the menu.
12	4K	Photo resolution	Indicates the current photo resolution.
13		Timelapse mode	Indicates the current Timelapse mode. Touch to switch to Photo or Video mode.

4.4 Playback pictures and videos

You can use this feature to view pictures and videos.

1. Touch  to enter **Playback** mode.
2. You can touch **Edit** to enter Edit mode.
3. Touch to select the required pictures or videos, and touch  /  to **Delete** or **Download** the selected files on your mobile device.

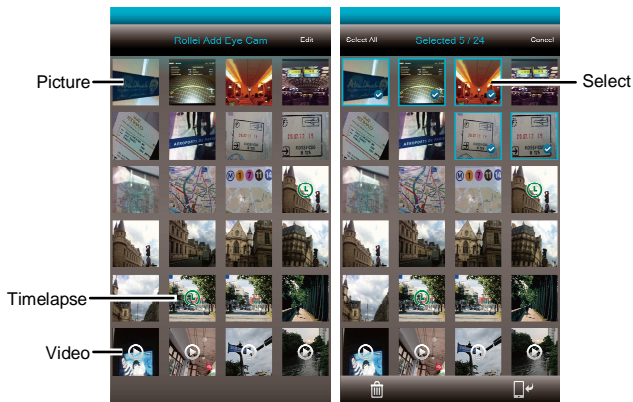



Note:

Rollei Add Eye Cam App is for users to preview approx. 800 of the most recent files. If you want to overview all recorded files, please use a computer or other media players to check.

4.4.1 Viewing pictures

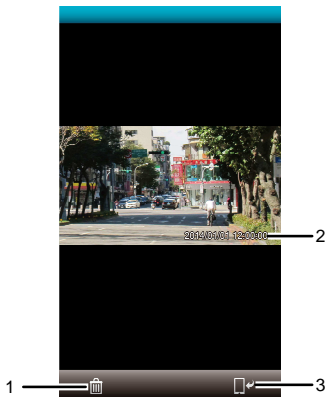
Touch the photo to view it in full screen.





No.	Icon	Item	Description
1		Delete	Touch to delete the current picture.
2	2014/01/01 12:00:00	Date and time	Indicates the recorded date and time.
3		Download	Touch to download the current picture.

4.4.2 Playing videos

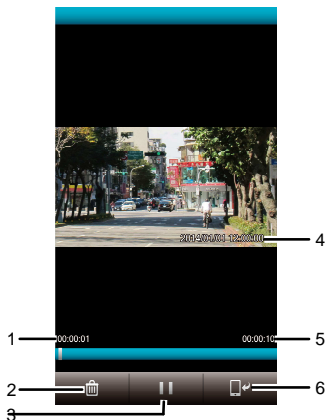
Touch the video to play it in full screen.



No.	Icon	Item	Description
1	00:00:01	Current duration	Indicates the video current duration.
2		Delete	Touch to delete the current video.
3		Stop	Touch to pause the video playback.
4	2014/01/01 12:00:00	Date and time	Indicates the recorded date and time.
5	00:00:10	Total duration	Indicates the video total duration.

No.	Icon	Item	Description
6		Download	Touch to download the current video.



Note:

1. Video recorded using *Timelapse* is a string of pictures, therefore there is no audio when played back.
2. The Life Cam App is only applicable for previewing a video without audio playback. To view the integral video content, download the file to your mobile device or PC for playback.
3. Deleted files cannot be recovered. Ensure the files have been backed-up before deletion.
4. Picture and video files could be downloaded to the internal memory of your mobile device. Use the application program in your mobile device to view the file.
5. **If you find the downloaded files could not be played or without sound, which means the mobile phone itself does not support the video decoding. It's not the problem of the file. We recommend you to install a free App software, such as VLC to play.**
6. IOS mobile device operating systems: Due to the resolution limit, which may result in the recorded videos could not be downloaded to your mobile device. If you want to upload the recorded video files to the Internet, it is recommended that you pre-set the video resolution, which can be supported by your mobile device, or you can use a computer to read the files on the memory card.

5 Settings menu

5.1 Using the settings

You can customize the video recording and other general settings via the on-screen display (OSD) menus.

1. If recording is in progress, please touch  to stop recording.
2. Touch  to enter the OSD menu.

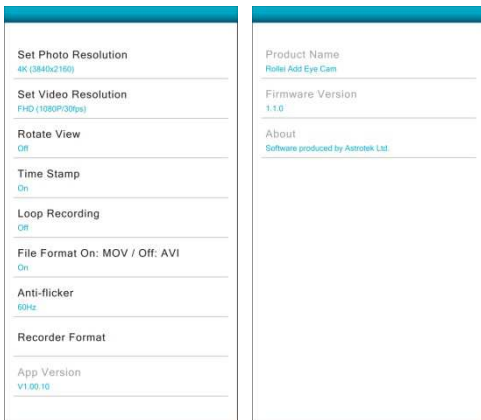

5.1.1 Menu items

Refer to the below table for details of menu items and available menu options.

Menu option	Description	Available option
Set Photo Resolution	Set the desired photo resolution.	4K (3840x2160) / 5M (2576x1932) / 2M (1920x1080)
Set Video Resolution	Set the desired video resolution.	FHD (1080P/30fps) / HD30 (720P/30fps)
Rotate View	Prior to recording video, you may set Rotate View to alter the viewing angle of the recorded video.	Off / Flip Vertical / 180° Rotate
Time Stamp	Imprint the date and time on the recorded photo or video.	On / Off
Loop Recording	If start Loop Recording function, when the memory card storage space is insufficient, the older files will be overwritten.	On / Off
File Format On: MOV / Off: AVI	Set Timelapse photography and general video file formats.	On / Off
Anti-flicker	Domestic power supply varies by area. It is recommended that you should check the "Table of voltage and frequency of different countries" for the correct setting.	50Hz / 60Hz

Menu option	Description	Available option
Recorder Format	Format the memory card inserted in the equipment. All the files in the card will be erased.	No / Yes
App Version	Indicates the current application version.	
Product Name	Display the model number of the device.	Rollei Add Eye Cam
Firmware Version	Indicates the current firmware version.	
About	The App software maker.	Software produced by Astrotek Ltd.

6 Connecting to other devices

6.1 Connecting to the computer

You can connect the device to a desktop computer or notebook to transfer or view files.

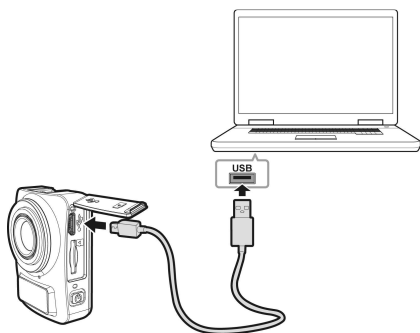

7 Installing the software

1. Place the attached CD ROM into the CD player.
2. If the CD does not execute automatically, please use Windows File Manager to execute the **Install_CD.exe** file in the CD.

The following screen will be shown up.



3. Press the [Menu] item to start the installation process according to the instructions on-screen.

8 Editing software



MAGIX Video easy SE is the perfect beginner program for the whole family. Thanks to the intuitive program interface with extra large buttons, a wide range of help functions and practical wizards, you can transform your recordings into amazing videos, even if you don't have any previous experience.

Your pictures, videos and music online. Let your friends and family participate in your experiences.

- Free Online Album with your own web address.
- High-quality design templates.
- Unique design.
- Slideshows with text, music, and effective transitions.
- Upload videos and play them.
- You can go <http://www.magix.com/us/> to for more information.

System requirements: Windows XP / Vista / Win 7 / Win 8

Note:

1. The **MAGIX Video easy SE** software is only applicable to a Windows operating system
2. Before using Magix edit software, please download QuickTime video player first.

9 Specifications

Item	Description
Image Sensor	8MP, 1/3.2" CMOS
F/NO	F2.4
Lens	Fixed focus lens
Focus Range	80 cm ~ infinity
Timelapse	Resolution: 4K (3840x2160); 5M (2576x1932); 2M (1920x1080)
	Format: JPG; AVI / MOV
Still Image	Resolution: 4K (3840x2160); 5M (2576x1932); 2M (1920x1080)
	Format: JPG
Movie Clip	Resolution: FHD (1080P/30fps); HD30 (720P/30fps)
	Format: AVI / MOV
Shutter	Electronic Shutter Auto :1/60 ~ 1/4000 sec
ISO	Auto
White Balance	Auto
Microphone	Yes
Buzzer	Yes
Interface	Micro USB
Waterproof Function	IPX5 – Protected against water jets; IPX8 for Waterproof Case (optional)

Item	Description
Storage Media	Supports Micro SD (HC,XC) class 10 or above, up to 32GB
Battery	Built-in 700mAh Li-polymer rechargeable
Operating Temperature	0° ~ 50° C (14° ~ 122° F)
Operating Humidity	0 ~ 95% RH
Storage Temperature	-20° ~ 70° C (-4° ~ 140° F)
Dimensions	38.5 x 50.3 x 20.4 mm
Weight	Approx. 36g (without memory card)

Built-in IEEE 802.11n Wi-Fi module: WN7911B-WM

Frequency range	2412~2462MHz
Channel List	Ch1~Ch11

Contains FCC ID: 2ACFIWM7911B

10 License Statement

The software used in this product is licensed subject to a license pursuant to the GNU – General Public License conditions. We expressly draw attention to the fact that under the GNU – General Public License conditions no liability is accepted.

The starting point for the software is the software published online at

<http://sg-gpl.net/>

The software listed there is licensed pursuant to the GNU – General Public License conditions.

Device-related changes have been made to this software for the product in question. The source text of the software implemented in the product in question can be obtained in response to an enquiry sent to the e-mail address

info@rollei.com

In this instance your e-mail must contain details of what the relevant product is, the relevant serial number and documentary evidence of your commercial source of supply as well as documentary evidence of the date on which the product was purchased from the trade source of supply. We guarantee supply of the source text of the implemented software for a period of at least three years from date of purchase from the trade source of supply where the trade source of supply has sourced the product from us directly or via strictly trade-only dealers.

Copyright © 2014

All rights reserved.

All other marks, products or company names mentioned in this guide are trademarks of their respective companies.