

# Preface

## About this Manual

- The contents of this manual and the bundled Basic Reference are subject to change without notice.
- Note that the example screens and product illustrations shown in this User's Guide may differ somewhat from the screens and configuration of the actual camera.

## Copyright

This manual contains proprietary information protected by copyright. All rights are reserved. No part of this manual may be reproduced by any mechanical, electronic or other means, in any form, without prior written permission of the manufacturer.

© Copyright 2017

## Trademark Recognition

Windows XP/Vista/Win7/Win 8/Win 10 are registered trademarks of Microsoft Corporation in the United States and/or other countries. Windows is an abbreviated term referring to the Microsoft Windows Operation System. All other companies or product names are trademarks or registered trademarks of their respective companies.

## **Safety and Handling Precautions**

### **Camera Information**



- Do not take apart or attempt to service the camera yourself.
- Do not expose the camera to moisture, or extreme temperatures.
- Allow the camera to warm up when moving from cold to warm temperatures.
- Do not touch and put pressure on the camera lens.
- Do not expose the lens to direct sunlight for extended periods.
- Do not use abrasive chemicals, cleaning solvents or strong detergents to clean the product. Wipe the product with a slightly damp soft cloth.
- Do not use the flash or LED Light near a person's eyes to prevent possible eye injury.
- To prevent you from falling over or resulting in traffic accident, please do not use the camera while you are walking, driving or riding a vehicle.
- Please handle the camera strap with care, and never place the strap around the neck of an infant or child. Wrapping the strap around a neck may cause suffocation.
- Do not subject the LCD monitor to impact.
- To prevent the risk of fire or electric shock, do not expose this appliance to rain or moisture.

### **Battery Information**

- Turn off the camera before installing or removing the battery.
- Use only the provided batteries or type of battery and charger that came with your camera. Using other types of battery or charger may damage the device and invalidate the warranty.
- Inserting the battery upside down can cause damage to the product and possibly cause an explosion.
- When the camera is used for an extended period of time, it is normal for the camera body to feel warm.
- Download all pictures and remove the battery from the camera if you are going to store the camera for a long period of time.
- The type of battery and the battery power level may cause the lens to be stuck up. Ensure you use the correct battery type and use a fully charged battery.
- Risk of explosion if battery is replaced by an incorrect type. Dispose of used batteries according to the instructions.
- Please keep the batteries out of the reach of children to prevent from swallowing batteries, which might cause poisoning.

## Using this Menu

Symbols used in this manual are explained below:

	This indicates useful information when using your camera.
	This indicates important message that should be read before using the function.

## Table of Contents

Preface .....	1
About this Manual.....	1
Safety and Handling Precautions .....	2
Using this Menu.....	3
Introduction.....	7
System Requirements .....	7
Main Features.....	7
Package Contents .....	8
Camera Views .....	9
Camera Buttons.....	11
Navigation Control .....	12
Getting Started .....	14
Inserting the Battery.....	14
Camera Memory .....	15
Inserting an SD/SDHC/SDXC Memory Card .....	16
Charging the Battery by USB .....	17
Turning the Power On and Off .....	17
Initial Settings .....	18
Modes .....	18
Using the LCD monitor.....	19
LCD Monitor Layout .....	19
Recording Images and Videos .....	24
Taking Images.....	24
Setting the Zoom Control .....	24
Using the AE/AF LOCK/UP Button.....	25
Using Flash .....	26
Setting the Focus Mode .....	27
Setting Continuous Shooting.....	28

Using the Function Menu/Delete Button.....	29
Using the Movie Menu.....	34
Recording Videos.....	38
Using the Record Menu.....	48
Playback.....	56
Viewing in Single Navigation.....	56
Viewing Thumbnails.....	56
Magnify.....	57
Playing Videos.....	58
Playing Voice Memo.....	59
Playback Menu.....	60
Using the Setup Menu.....	71
Setting Sounds.....	71
Setting Power Save.....	72
Setting Date & Time.....	72
Setting Language.....	73
Setting Display Mode.....	73
Setting TV Out.....	73
Setting LCD Brightness.....	74
Setting Format.....	74
Reset All.....	74
Making Connections.....	75
Connecting the Camera to a TV.....	75
Connecting the Camera to a PC.....	75
Connecting the Camera to a Printer.....	76
Setting the Print Mode Menu.....	77
Appendix.....	78
About Folder and File Names.....	78
Troubleshooting.....	78

Specifications..... 80  
Disposal ..... 83  
Conformity..... 84

## Introduction

Congratulations on your purchase of the new digital camera.

Capturing high-quality digital images is fast and easy with this state-of-the-art smart camera.

## System Requirements

In order to get the most out of your camera, your computer must meet the following system requirements:

### For Windows:

- Windows XP/Vista/Win7/Win8
- Processor: Intel Pentium D 3.0GHz or equivalent AMD Athlon, or faster
- Memory: 2 GB or above
- HDD space: 300MB or above
- 32bit color display monitor
- Microsoft DirectX 9.0C
- USB port and CD-ROM drive

### For Macintosh:

- Mac OS 10.3.9 ~ 10.8 <Digital Camera>
- Memory: 1 GB or above
- Q. Time player ver. 6.0.3 or above
- USB port and CD-ROM drive

## Main Features

- 20 mega pixels resolution
- Up to 5x optical zoom and 8x digital zoom
- 2.7 inch color LCD monitor
- 64MB internal flash memory with optional external SD/SDHC/SDXC card
- Supports up to 4GB of SD card, and up to 32GB of SDHC card and to 64GB of SDXC card
- Easy-to-use button interface
- DCF, DPOF, PictBridge compatibility
- Slide show enables you to playback photos, videos and corrupted files
- A/V output to view your images and videos on your TV
- USB port to transfer images and videos to your PC

## Package Contents

Please check the contents of your camera package. It should contain:



Digital camera



Rechargeable battery  
x 1 pcs



USB cable



Wrist strap

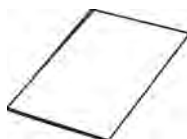

Quick Start Guide  
(printed in German and  
English)



## Camera Views

### Front View

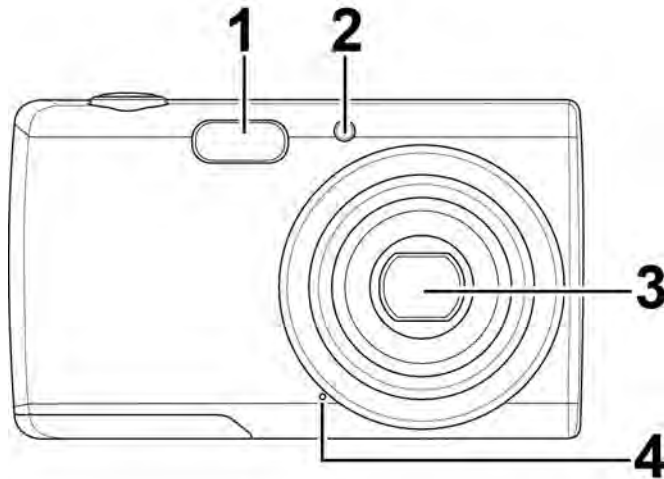

- 1. Flash
- 2. Self-timer LED
- 3. Lens
- 4. Microphone

### Back View

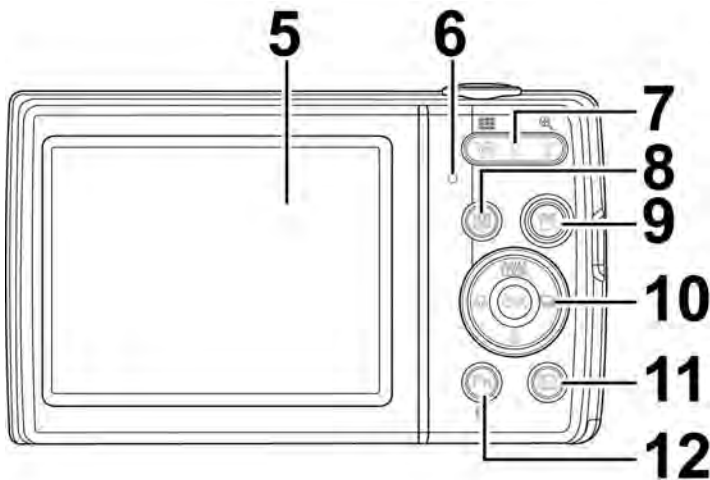

- 5. LCD monitor
- 6. LED indicator
- 7. Zoom button
- 8. Menu button
- 9. Movie button
- 10. OK button/4-way navigation control
- 11. Playback button
- 12. Fn/Delete button

## Top View

- 13. Power button
- 14. Shutter button

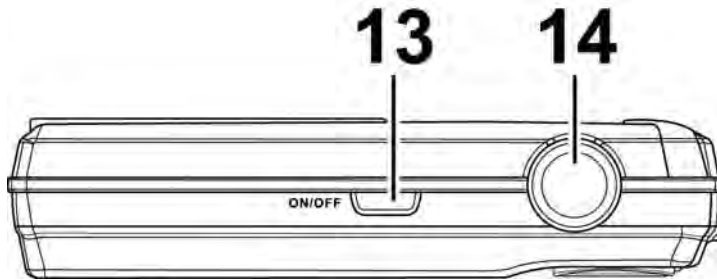

## Bottom View

- 15. Battery/  
Memory card  
compartment
- 16. Speaker
- 17. Tripod screw  
hole

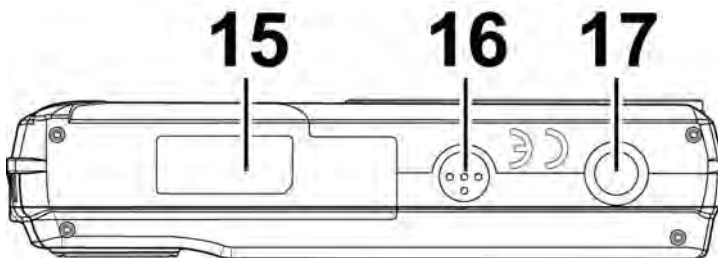

## Left/Right View

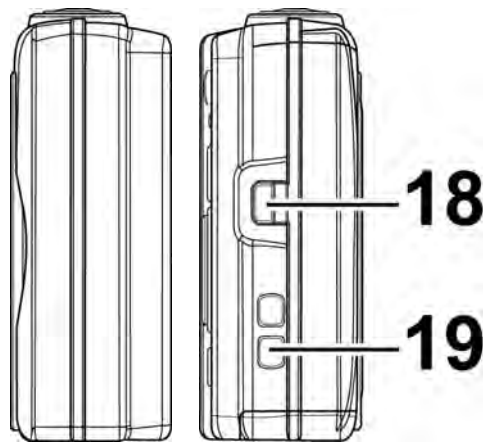

18. USB/TV Out

19. Strap ring

## Camera Buttons

Your camera is equipped with different buttons for ease of use.

Button	Description
Power	Press the Power button to turn the power on/off.
Shutter	Press to capture an image.
Zoom button	In photo and movie mode, Press the Zoom button (left/right) to zoom out/zoom in. In Playback mode, press button to zoom in to magnify image or zoom out enter 9-image/calendar thumbnails.
Menu	Press to enter or exit menu/submenu.
Fn/Delete	In Photo mode, press to enter function menu. In Playback mode, press to delete an image or video clip.
Playback	Press to enable Playback mode or return Record mode.
Movie	Press to start/stop recording video.

## Navigation Control

The **4-way Navigation Control** and the **OK** button allow you to access the various menus available from the On Screen Display (OSD). You can configure a wide range of settings to ensure maximum results from your images and videos. Further functions of these buttons are as follows:

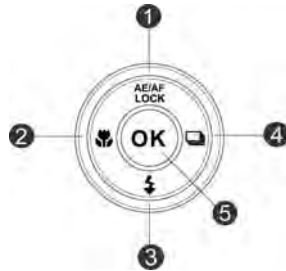

No.	Description
1	AE/AF LOCK
2	Macro Button
3	Flash Button
4	Continuous Shooting Button
5	OK Button

Button	Description
AE/AF LOCK/Up	<ol style="list-style-type: none"> <li>To lock AE/AF, press the AE/AF LOCK/Up button in Program Mode or half press the shutter button and then press the AE/AF LOCK/Up button.</li> <li>To unlock AE/AF by any one of the following ways: <ul style="list-style-type: none"> <li>Press the AE/AF LOCK/Up button</li> <li>Press the Zoom button</li> <li>Press the MENU/Fn/Playback/Movie/Power button to launch another function</li> <li>Switch to Super Macro/Manual Focus (For unlocking AE only)</li> </ul> </li> <li>In Menu, press to navigate through the menu and submenu selections.</li> </ol>

Macro/Left	<ol style="list-style-type: none"> <li>1. In Photo Mode, press to scroll through Macro options. (Auto Focus, Super Macro, Pan Focus, Infinity and Manual Focus)</li> <li>2. In Playback mode, press to view the previous image, video or audio clip.</li> <li>3. In Playback movie mode, press to rewind video playback.</li> <li>4. In Menu, press to exit a submenu or to navigate through the menu selections.</li> </ol>
Flash/Down	<ol style="list-style-type: none"> <li>1. In Photo Mode, press to scroll through the flash mode options. (Auto, Red-eye Reduction, Forced On, Slow Sync and Forced Off)</li> <li>2. In Menu, press to navigate through the menu and submenu selections.</li> </ol>
Continuous Shooting/Right	<ol style="list-style-type: none"> <li>1. Press to scroll through Continuous Shooting options. (Single shot, Burst, Speedy Burst and GIF Capture)</li> <li>2. In Playback mode, press to view the next image or video.</li> <li>3. In playback Movie mode, press to forward video playback.</li> <li>4. In Menu, press to enter the submenu or to navigate through the menu selections.</li> </ol>
OK	<ol style="list-style-type: none"> <li>1. Confirm a selection when using the OSD menus.</li> <li>2. In Playback Movie/Audio mode, press to start video or audio playback.</li> </ol>

# Getting Started

## Inserting the Battery

Follow these instructions to insert the rechargeable battery into the battery/memory card compartment.

Please read "Battery Information" on page 2 before inserting/removing batteries.

1. Make sure the power is off before inserting the battery.

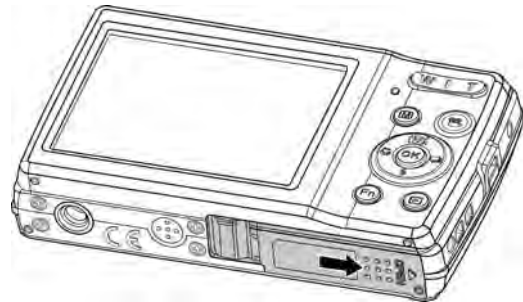

2. Unlock and open the battery/memory card compartment at the bottom of the camera.

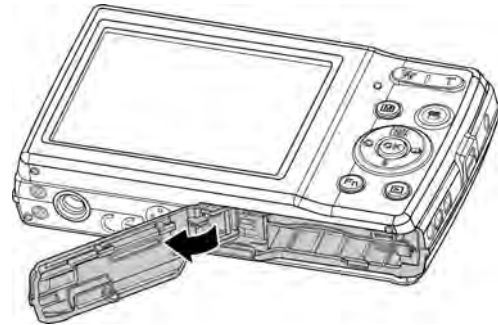

3. Insert the batteries into the compartment with the terminal facing inside the camera with correct orientation as shown.

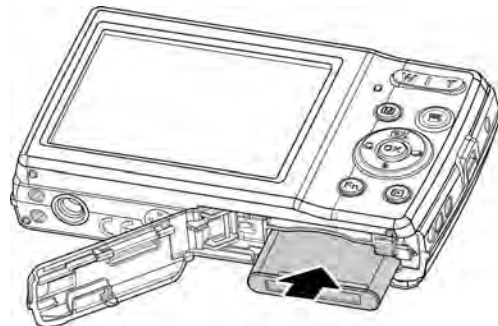

4. Close and lock the battery/memory card compartment. In order to prevent the battery from dropping, please make sure the compartment is locked firmly.

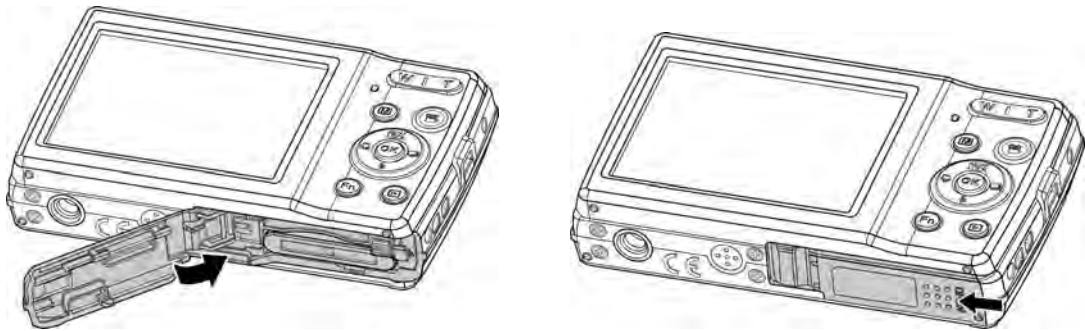

## Camera Memory

### Internal memory

Your camera is equipped with 64 MB of internal memory. Users can store files up to approximately 25 MB. If there is no memory card inserted in the memory card slot, all images and videos recorded are automatically stored in the internal memory.

### External storage

Your camera supports SD cards of up to 4 GB in size. It also supports SDHC cards with a maximum capacity of 32 GB. Then also supports SDXC cards with a maximum capacity of 64 GB. If there is a storage card inserted in the memory slot, the camera automatically saves all images and videos in the external storage card. The icon  indicates the camera is using SD card.



Not all cards may be compatible with your camera. When purchasing a card, please check the card's specifications and take the camera with you.

## Inserting an SD/SDHC/SDXC Memory Card

Expand your camera's storage by using SD, SDHC or SDXC memory cards.

1. Unlock and open the Battery/memory card compartment at the bottom of the camera.
2. Insert the SD/SDHC/SDXC card into the memory card slot with the metallic part facing the back side of the camera.
3. Push the SD/SDHC/SDXC card into the memory slot until it clicks into place.
4. Close and lock the Battery/memory card compartment.

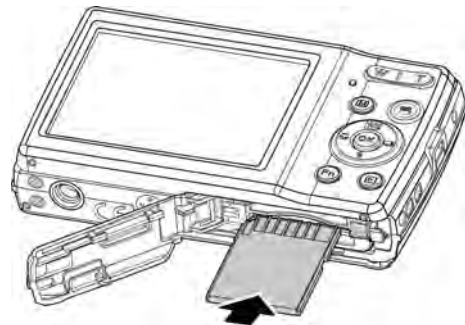
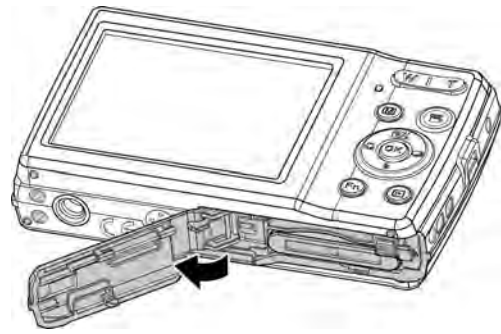

To remove the SD/SDHC/SDXC card

5. Unlock and open the battery/memory card compartment.
6. Gently push the card until it pops out.
7. Pull out the card carefully.

- Windows 2000/XP does not support SDXC card (exFAT format). But in Windows XP (Service Pack 2 or 3), you can download exFAT patch update to support SDXC card.
- To use the SDXC card with Mac OS, the OS version should be 10.5 or higher.
- The memory card that is not inserted correctly may cause damage to the camera. Please be careful when inserting the memory card.
- To prevent children from swallowing the memory card, please keep the memory card out of reach of children.





## Charging the Battery by USB

In other way charging the battery, you can use the USB cable to connect the camera with PC or USB adapter.

1. Connect the camera with the USB cable as shown.
2. Connect the other end with the USB adapter (not included) and plug it into a power outlet or with the USB port of PC directly for charging.

- When the battery is charging, the LED indicator flashes.
- When the battery is fully charged, the LED indicator goes off.
- When the battery is unusual charged, the LED indicator flashes rapidly.
- When the camera charges without the battery inside, the LED indicator goes off.

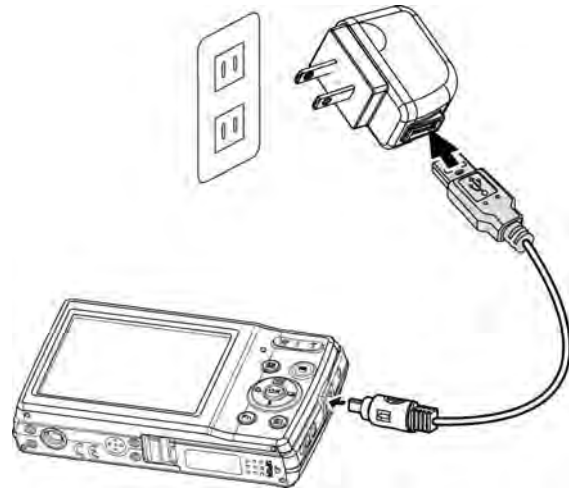

- It's recommended not operating the camera when charging. Actual charging time depends on current battery capacity and charging conditions.
- You can also charge the battery with Apple adapter. Its power output meets the standard 5V/500mA.
- When the battery is removing during charging, it will recover charging after you unplugging and replugging USB.



## Turning the Power On and Off

There are two ways to turn on the camera:

- The startup image displays briefly and the startup sound plays if enabled. The zoom lens extends and the camera is turned on in Record mode.
- The camera is turned on in Playback mode. The zoom lens is not extended.

To turn off the camera, press the **Power button**.

See "Modes" on page 18 to know more about Record and Playback mode.

## Initial Settings

When you turn on your camera for the first time, you will be asked to do the initial settings of your camera. First is the setup of language menu. Specify in which language menus and messages are to be displayed on the LCD monitor.

### Setting the Language

1. Press ▲, ▼, ◀ or ▶ to move through the selection.
2. Select a language, and then press **OK** to apply.

### Setting the Date & Time

1. Press ◀ or ▶ to move through the selection.
2. Press ▲ or ▼ keys to change the value for the date and time.
3. Press **OK** to apply.
4. If necessary, press  to Cancel select and return to language.

Now, you are ready to start taking images and videos.



Holding down ▲ or ▼ keys to change the values continuously.

## Modes

Your camera has three modes:

### Record Mode

This is the default mode while you turn on the camera every time. You are able to take images in this mode.

### Playback mode

Press the **Playback button**  after the camera is turned on to view and edit captured images or playback videos. The recording of voice memo attached to images is available in this mode.

### Movie mode

Press the **Movie button**  after the camera is start/stop recording video in this mode.

## Using the LCD monitor

The LCD monitor shows all important information regarding camera settings as well as the visual image of your image or video. The display on the LCD monitor is called the On Screen Display or OSD.

### LCD Monitor Layout

#### Photo Mode Screen Layout

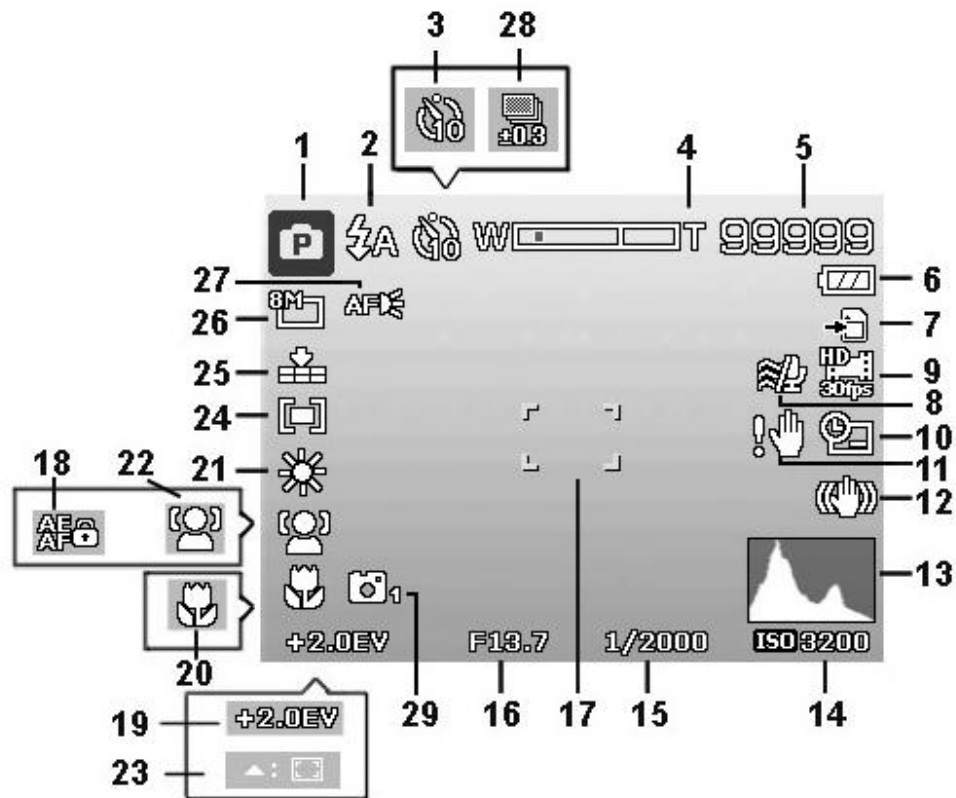

No.	Item	Description
1	Record Mode	Indicates the current mode.
2	Flash	Indicates flash settings.
3	Self-timer	Indicates Self-timer settings.
4	Zoom indicator	Displays zoom.
5	Shots remaining	Indicates the remaining shots available.
6	Battery	Indicates battery level.
7	Storage media	Indicates current storage media in use.
8	Wind Cut	Reduces wind noise during movie recording.
9	Movie size	Indicates movie size.
10	Date stamp	Indicates date stamp is enabled.

11	Shake warning	Indicates the light is not enough and the camera is shaking, which may cause the captured image blurred. If the shake warning appears, you can still capture images. However, enable Stabilizer, flashlight or use tripod is recommended, these ways will stabilize the camera.
12	Stabilizer	Indicates stabilizer function is enabled.
13	Histogram	Graphic display of Brightness.
14	ISO	Displays ISO settings.
15	Shutter speed	Displays shutter speed settings.
16	Aperture value	Displays aperture settings.
17	Focus area	Indicates focus area.
18	AE/AF Lock	Indicates AE/AF Lock is enabled.
19	EV Compensation	Displays exposure compensation settings.
20	Focus mode	Indicates focus is enabled.
21	White balance	Displays white balance settings.
22	Face tracking	Indicates face tracking is enabled.
23	Tracking AF	Indicates tracking AF is enabled.
24	Metering	Displays metering settings.
25	Quality	Displays quality settings.
26	Photo size	Displays photo size settings.
27	AF lamp	Indicates AF lamp is enabled.
28	Exposure bracketing	Displays Exposure bracketing settings.
29	Stylish	Indicates Stylish function is enabled.

## Movie Mode Screen Layout



Recording Layout

No.	Item	Description
1	PIV available	Indicates that you can capture screenshot without stopping movie recording.
2	Recording status	Indicates recording status.
3	Recorded time	Displays recorded time.
4	Key indicator	Displays the commands on 4-way Navigation Control button.

## Playback Mode Screen Layout

The Playback mode display varies depending on the type of image being viewed.

### Playback mode display of still images:

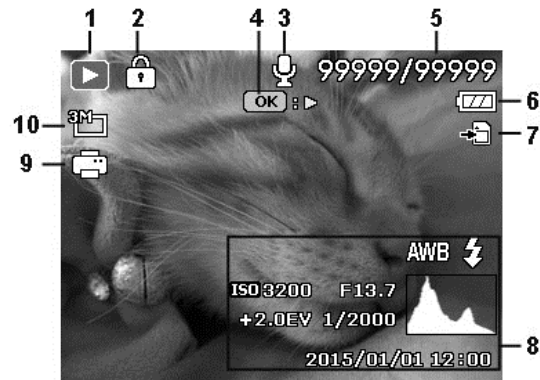

No.	Item	Description
1	Playback mode	Indicates playback mode.
2	Protect	Indicates file is protected.
3	Voice memo	Indicates voice memo is attached.
4	Button intro	Indicates the button to press on the camera to play a video file.
5	File no./Total no.	Indicates the file number over the total number of files in the storage card.
6	Battery	Indicates battery level.
7	Storage media	Indicates used storage memory.
8	Recording information	Displays recording information of the file.
9	DPOF	Indicates the file is marked for printing.
10	Image Size	Displays the image size settings.

## Playback mode of videos:

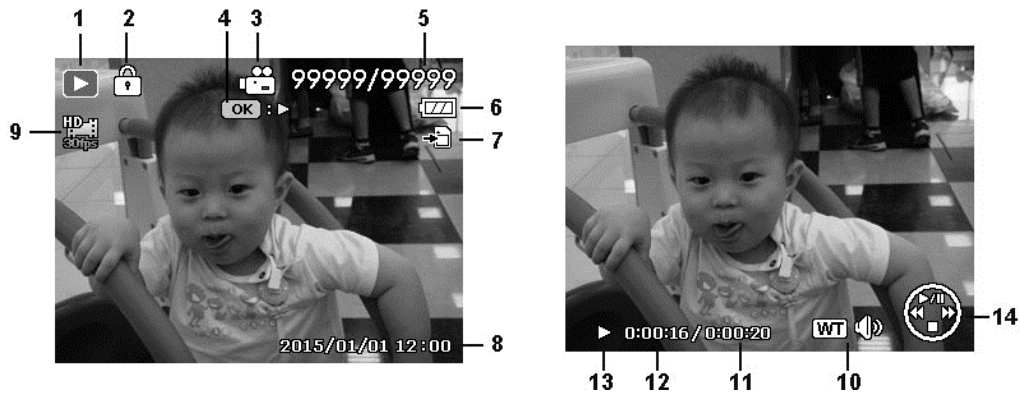

No.	Item	Description
1	Playback mode	Indicates playback mode.
2	Protect	Indicates file is protected.
3	Video clip	Indicates the file is a video.
4	Button indicator	Displays the button info of Playback mode.
5	File no./Total no.	Indicates the file number over the total number of files in the storage card.
6	Battery	Indicates battery level.
7	Storage media	Indicates used storage memory.
8	Recording date & time	Displays the date and time of the video clip.
9	Video size	Indicates the size of the video clip.
10	Button intro	Indicates the button to press on the camera to adjust the volume.
11	Video length	Display the total length of the video clip.
12	Played time	Indicates the played time of the video.
13	Playing status	Displays playing status.
14	Button intro	Indicates the button to press on the camera to play a video file.

# Recording Images and Videos

## Taking Images

Now that you are familiar with your camera, you are now ready to take your images. Taking images with your camera is very simple.

1. Turn on the camera by pressing the **Power button**.
2. Frame the shot using the focus bracket on the LCD monitor. See illustration on the right.
3. Pressing the **Shutter button** down halfway automatically focuses and adjusts the exposure, and pressing the **Shutter button** down fully captures the images.

When the shake warning icon  appears, hold the camera steadily, with your arms at your side or use a tripod to stabilize the camera to prevent blurred images.

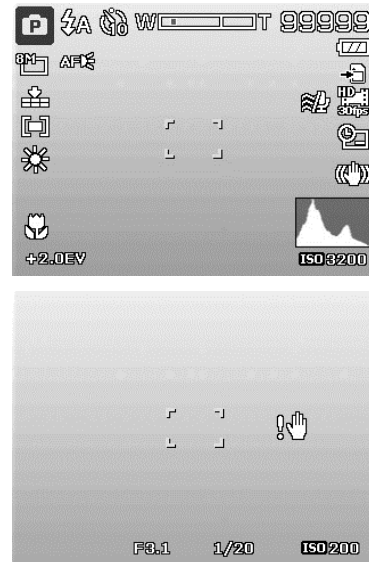



## Setting the Zoom Control

Using a combination of 5 times optical zoom and 8 times digital zoom permits zoom photography at up to 40 times magnification. While the digital zoom can be a useful feature, the more an image is enlarged (zoomed), the more pixelated (grainier) the image will appear. Please refer to "Setting the Digital Zoom" on page 53 on how to setup digital zoom.

To adjust the optical zoom:

1. Press the Zoom button to zoom in or zoom out an image.
2. The zoom indicator appears on the LCD monitor. **W**  **T**

### Zoom button

1. Press the Zoom button (right) to zoom in. 
2. Press the Zoom button (left) to zoom out. 

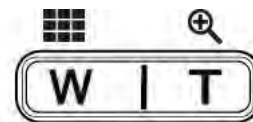



To adjust the digital zoom:

1. Activate digital zoom. See "Setting the Digital Zoom" on page 53.
2. Press the **Zoom button** (left/right) optically zooms in/out to the maximum until it stops.
3. Release the **Zoom button**.

**5x optical zoom**                      **8x digital zoom**

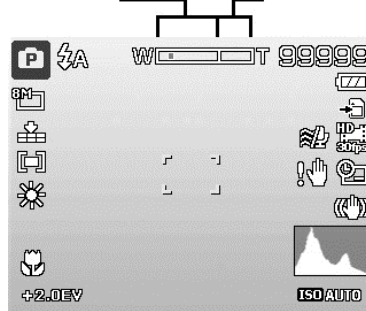

## Using the AE/AF LOCK/UP Button

Use the AE/AF LOCK/UP button on your camera to lock focus and exposure.

1. To lock AE/AF, press the AE/AF LOCK/Up button in Program Mode or half press the shutter button and then press the AE/AF LOCK/Up button.

### AE/AF LOCK/UP Button



2. To unlock AE/AF by any one of the following ways:
  - Press the AE/AF LOCK/UP button
  - Press the Zoom button
  - Press the MENU/Fn/Playback/Movie/Power button to launch another function
  - Switch to Super Macro/Manual Focus (For unlocking AE only)

## Using Flash

When taking pictures in difficult lighting conditions, use the **Flash/Down** button to get correct exposure. This function cannot be activated in recording videos or continuous shooting.

To activate Flash:

- Press the **Flash/Down** button on your camera repeatedly until your desired flash mode is displayed on the LCD monitor.





**Flash/Down  
button**

Your camera is equipped with five flash modes:

 **Auto Flash.** The flash fires automatically whenever extra lighting is needed.

 **Red-eye reduction.** The flash fires twice to reduce the red-eye effect.

 **Forced on.** The flash fires whenever you press the Shutter button regardless of lighting conditions.

 **Slow sync.** The flash fires with a slow shutter speed.

 **Forced off.** The flash is turned off.



- Flash function is only available in shooting still images but not available in Burst and GIF modes.
- Do not charge the flash while pressing the Zoom button. Charge the flash after releasing the Zoom button if necessary.

## Setting the Focus Mode

This function allows users to define the type focus when recording a still image.



To set the Focus mode

- Press the **Focus/Left** button on your camera to launch the Focus function.
- To select focus options, press the ◀ or ▶ keys. Press the **OK** button to save and apply changes.



Your camera supports the 4 focus modes:

**AF Auto Focus.** With auto focus, the camera will focus on the subject automatically.

  **Macro/Super Macro.** This mode is designed for close-up photography. When Super Macro is set, the focus cannot be adjusted until Super Macro is canceled.

 **Infinity.** When Infinity is set, the camera focuses on distant objects.

**MF Manual Focus.** With manual focus, you can adjust the focus distance from 5cm to infinity by press Up/Down button. Press OK button to lock the focus and exit the adjusting screen.



## Setting Continuous Shooting

This function allows users to set the continuous shooting mode. It's only available in shooting still images. Press Right button to launch the Continuous Shooting menu options, and then press Left/Right button to select the desired option.

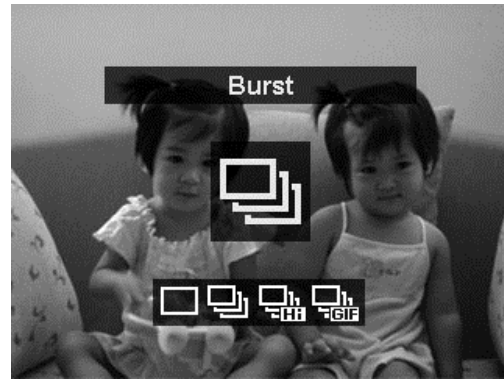

**Continuous Shooting/Right button**

Icon	Item	Description
	Single Shot	Disable the continuous shooting function.
	Burst	Full press and hold the shutter button to take a continuous shooting until release the shutter button or memory card is full.
	Speedy Burst	Captures 30 images in a shot when the Shutter button is pressed. Auto set Image size to 4:3 VGA only.
	GIF Capture	Use this feature to take a specific number of images in a specific shooting interval. The taken images will be combined into a GIF file and no longer exist individually.

## Using the Function Menu/Delete Button

### Function Menu

Press the **Fn/Delete** button in Record mode will bring up the Function Menu with most common features for photos and movies.



Press the **Fn/Delete** button of your camera to launch the Function Menu.

Press the **Fn/Delete** button again to close the menu.

### Menu Options

- The Menu bar displays the current status of your camera settings. Only the available functions for the settings are shown as icon on the menu bar.
- The available options for each item on the menu bar are shown in the Menu options.
- Use the ◀ or ▶ key to move through the menu selections then press the **OK** button to save and apply changes.
- Press **Menu** button or **Fn/Delete** button to cancel selecting and close Function Menu.

### Menu bar











## Photo Size

The Photo Size function is used to set the resolution before you capture the image. Changing the Photo Size affects the number of images that can be stored in your memory card. The higher the resolution, the more memory space is required.



The table below shows the Photo Size values for still images.

Icon	Pixel Size	Printing Size Suggestion
	5152 x 3864	A2 Size
	3264 x 2448	A3 Size
	2592 x 1944	A4 Size
	2048 x 1536	4" x 6"
	640 x 480	E-mail

Icon	Pixel Size	Printing Size Suggestion
	5152 x 3435	Standard print paper
	5152 x 2898	HDTV
	1920 x 1080	HDTV
	2992 x 2992	Square Composition

## EV Compensation

Images can be captured with the overall scene intentionally made brighter or darker. These settings are used when a suitable brightness (exposure) cannot otherwise be obtained in circumstances where the difference in brightness between the subject and the background (the contrast) is large, or when the subject that you wish to capture is very small within the scene. Available for still images only.

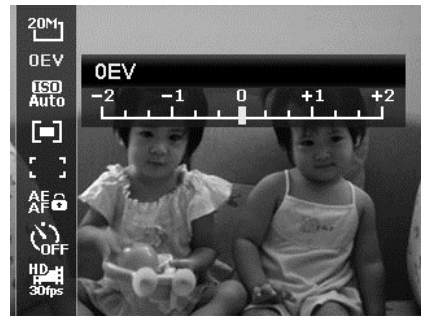

- To adjust EV settings, press the ◀ or ▶ keys to increase/decrease the value. As you adjust the settings, the LCD monitor synchronously displays the image applying the EV settings. Press the **OK** button to save and apply changes.



- The EV compensation is enabled only when using Program mode.
- The EV menu is hidden if the Tracking AF has been turned on.

## ISO

This sets the sensitivity for capturing images. When the sensitivity is raised (and the ISO figure is increased), photography will become possible even in dark locations, but the more pixelated (grainier) the image will appear.

- Use a higher ISO setting in dim conditions and a lower ISO setting in brighter conditions.



## Metering

This sets the metering method for calculating the exposure.



Icon	Item	Description
	Multi	The entire area of the screen is measured, and the exposure is calculated.
	Center	Averages the light metered from the entire frame, but gives greater weight to the subject matter at the center.
	Spot	A very small portion of the center of the screen is measured, and the exposure is calculated.

## AF Area

AF stands for Automatic Focus. This feature determines the area on which the camera focuses.

To set AF Area

1. From the Record menu, select **AF Area**.
2. Use the ▲ or ▼ keys to go through the selection.
3. Press the **OK** button to save and apply changes.



The table below shows the available AF area settings.

Icon	Item	Description
	Face Tracking	This feature auto detects faces and tracks continuously.
	Wide	The camera automatically selects focus area within the wide frame.
	Center	The focus area is fixed on the center.



	Tracking AF	The camera will focus the subject as it moves and keep it continually in focus automatically.
---	-------------	---

## AE-L/AF-L

This feature allows locking exposure or focus or both of them by pressing AE/AF LOCK/UP button. You can define the AE/AF LOCK/UP button to be one of the following functions:

- AE-L: Lock/Unlock exposure.
- AF-L: Lock/Unlock focus.
- AE-L & AF-L: Lock/Unlock both of exposure and focus.



Press the AE/AF LOCK/UP button to unlock it.

## Self-timer



Your camera features a Self-timer which can be set in the Self-timer function in the Function Menu. The Self-timer allows you to take images after a pre-defined delay. While burst lets you take consecutive shots. This function is only available in recording still images. The Self-timer setting is automatically set to off when you turn off the camera.





To set the Self-timer

1. From the Function menu, select **Self-timer**.
2. Use the ▲ or ▼ keys to go through the selection.
3. Press the **OK** button to save and apply changes.

The table below shows the available Self-timer settings.

Icon	Item	Description
	Off	Captures an image without time delay.
	10 Sec.	Sets a 10-second delay to capture image after pressing the Shutter button.

	2 Sec.	Sets a 2-second delay to capture image after pressing the Shutter button.
	Double	Performs delay and capture twice: <ul style="list-style-type: none"> <li>• Performs a 10-second delay, then captures the image.</li> <li>• Performs another 2-second delay then captures the image again.</li> </ul>

## Using the Movie Menu

You can access the Movie menu simply by pressing the **MENU** button on your camera.

When the menu is displayed, use the 4-way navigation control and the **OK** button to move through menu selections and apply your desired settings. To close the menu anytime, press the menu button again.

## Setting Movie Mode

Use this function to adjust the resolution and quality of movie clips.

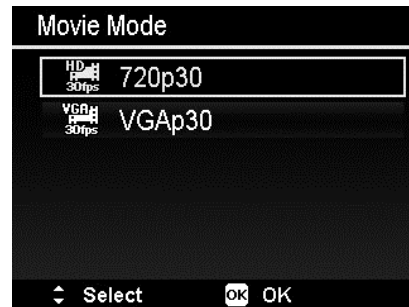

- The options FHD and HD are only available when a SDHC class 4 or class 6 card is inserted.
- Due to limits from the FAT format, VGA recording requires approximately 2 hours.

## Setting Prerecord

You can catch the first three seconds of action you would have potentially missed. Once enable this function, the camera starts recording video automatically before pressing Movie button. As soon as the Movie button is hit, the most recent three seconds of video is added to the beginning of the clip.

Display the icon in red while turning Prerecord on.

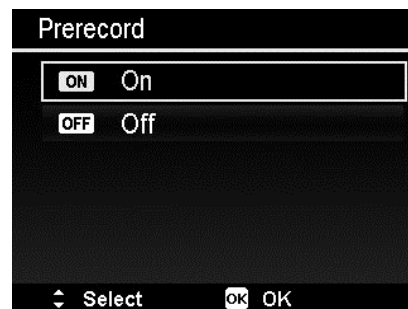



Prerecord will be canceled in the following situation:

- After recording starts.
- Switch to Playback mode.
- Launch the Menu.
- Enter USB mode.
- Power off the camera.



Prerecord function will be disabled in the following situations:

- The prerecord time is less than 2 seconds.
- There is not enough internal memory to enable this function unless an additional memory card is inserted to the camera.

## Setting Wind Cut

This feature reduces wind noise during movie recording.



## Continuous AF

This function allows you to record video with auto focus method.

1. Enable the Continuous AF under the Movie Menu.
2. Use the ▲ or ▼ keys to go through the selection.
3. Press the OK button to save and apply changes.

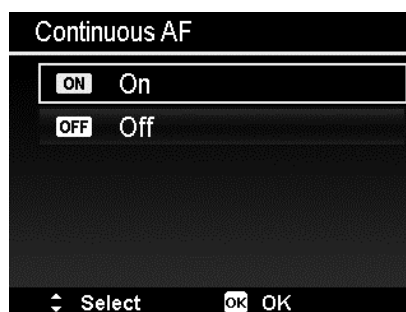

## Delete Button

The Delete function allows to remove unwanted files in the internal memory or on the memory card. Protected files cannot be erased, to delete, unprotect the file first. See "Protect" on page 61.

To delete an image/video clip:

1. Press the **Playback button**  on the camera.
2. View images/videos clips in Single navigation mode.
3. Use the ◀ or ▶ keys to scroll the display.
4. When the desired image/video clip is displayed on the LCD monitor, press the **Delete** button.
5. A confirmation selection appears on screen.
6. To close the Delete function and go back to the single navigation mode, press **Menu** button.

To delete a single file:

1. After a confirmation selection appears on screen. Select **Single**.
2. Press the **OK** button and select **Yes** to delete.
3. The next image is displayed on the LCD monitor. To delete another file, use the ◀ or ▶ keys to scroll through the images/videos clip. Repeat steps 1 to 2.
4. To close the Delete function and go back to the single navigation mode, press **Menu** button.



To delete attached voice memo:

1. After a confirmation selection appears on screen. Select **Single**.
2. A delete voice memo option will be added to the selection.
3. Select and press **OK** to delete voice memo only and back to single navigation.
4. Or select **Yes** to delete both image and its voice memo.

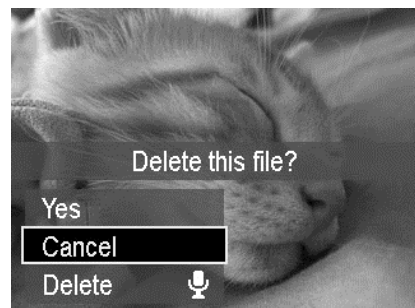

To delete multiple files:

1. After a confirmation selection appears on screen. Select **Multi**.
2. The images are displayed in thumbnail view on the LCD monitor.
3. Use the ◀ or ▶ keys to move through the files.
4. When the desired image/video clip is highlighted, use the ▲ or ▼ keys to mark/unmark image/video clip for deletion.
5. Repeat step 4 until all desired images for deletion are marked.
6. Press the **OK** button. A confirmation selection appears.
7. Select **Yes** to confirm.
8. Press the **OK** button to delete marked files.

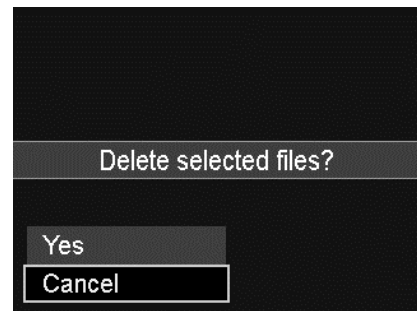
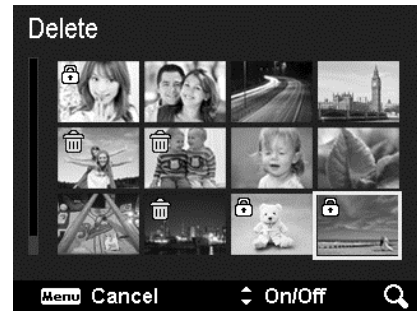

To delete all files:

1. After a confirmation selection appears on screen. Select **All**.
2. Select **Yes**.
3. Press the **OK** button to delete all files.

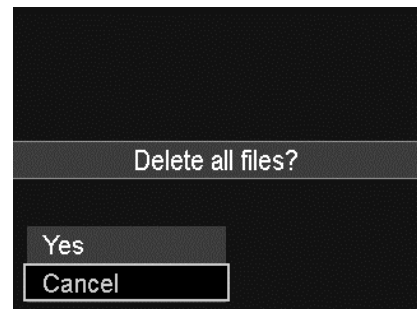

## Recording Videos

You can record videos with the camera, the available recording time depends on the capacity of the memory card. Videos can be recorded until the maximum memory capacity has been reached. However the length of a single video may be limited (the limitation depends on the camera model).



1. Press the **Movie button** to start

recording. 

2. Focus your camera on the subject that you want to take.
3. Use the **Zoom button** to zoom in and zoom out an image.
4. To stop recording, press the **Movie button**.



- The camera will automatically stop recording when the memory capacity is full.
- It will automatically stop recording when the recording time is over 29 minutes or the file size is over 4 GB.
- When the temperature of CCD Sensor is over 63°C, the camera will display the warning message.
- When the temperature of CCD Sensor is over 65°C, the camera will shutdown automatically.

## PIV function

During the movie recording, press shutter button, an icon  displays on LCD means that the current screen can be stored as a photo without stopping movie recording by full pressing the shutter button. The PIV feature only applicable to movie size: 720p30 and VgAp30.



- When the movie size is 720p (30fps), the capture photos are saved at 1280 x 720 resolution.
- When the movie size is VGA (30fps), the capture photos are saved at 640 x 480 resolution.

## Settings of Recording Videos

See "Using the Movie Menu" on page 34 for more details.

## Setting the Scene Mode





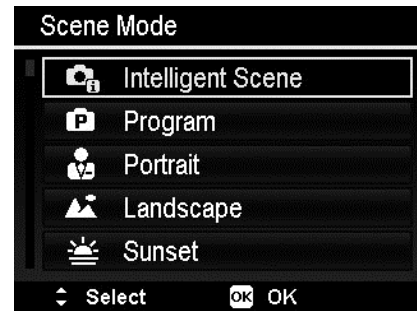





By simply selecting one of the following 23 modes, you can capture the image with the most appropriate settings.

1. From the Record Menu, press to select **Scene Mode**.
2. Use the navigation controls to move through the selection.
3. Press the **OK** button to save and activate the selected scene mode.



The table below shows the available scene mode settings.

Icon	Item	Description
	Intelligent Scene	The camera detects the shooting conditions and automatically switches to the appropriate scene mode. See "Using Intelligent Scene" on page 41 for more details.
	Program	The camera automatically adjusts suitable shooting settings like shutter speed and aperture values.
	Portrait	The camera blurs the background to focus on the subject.
	Landscape	This feature is used to emphasize wide scenic views.
	Sunset	This feature enhances the red hue for recording sunset images.
	Backlight	This feature is used to capture the image of a backlight object by changing the metering.
	Kids	This feature is used to capture still images of moving kids.
	Night Scene	This feature is used to capture images with night scenery background.
	Fireworks	This feature slows shutter speed to capture fireworks explosions.
	Snow	This feature is used for beach and snow scenes.
	Sports	This feature captures still images in high speed motions.

	Party	This feature is used for wedding or indoor party settings.
	Candlelight	This feature is used to capture warm candle light effects.
	Night Portrait	This feature is used to capture portrait pictures with night or dark background.
	Soft Skin	This feature enhances skin tone thus facial skin appears smooth.
	Flowing Water	This feature enhances smooth effects like water or silk.
	Food	This feature is used to capture food images. The increased saturation in this mode makes the captured image more enticing.
	Love Portrait	This feature uses face tracking to auto detect faces to capture portraits images without the help of others. When over two faces are detected, AF is automatically activated. The camera starts count down and captures a picture in two seconds.
	Self Portrait	This feature sets zoom to wide end. When one face is detected, AF automatically activated and plays the sound (Bi) for notice. Then camera starts count down and captures a picture in two seconds.
	D-Lighting	This feature applies digital processing only to the necessary portion(s) of the image and preserves details in highlights and shadows with natural contrast.
	Time Lapse	Use this feature to take photos automatically at the specified intervals. See "Using Time Lapse" on page 43 for more details.
	Panorama	Use this feature to create a panoramic photo by panning or tilting the camera.
<b>ART</b>	Art Effect	This feature applies different art effect on the still images.



## Using Intelligent Scene

This feature is most useful for novice users to capture great images even without basic knowledge of photography. Simply frame the shot with the help of Intelligent Scene Mode, the camera automatically recognizes 7 kinds of scenes - Portrait, Landscape, Macro, Backlight, Backlight Portrait, Night Scene and Night Portrait - and selects the ideal settings.

**Intelligent scene icon. After the camera detects the shooting conditions, this icon changes to show the detected scene mode.**



**The camera changed to Landscape mode automatically.**

To activate Intelligent Scene

1. Select **Intelligent Scene**  in **Scene Mode** menu.
2. Focus the camera on the subject to capture.
3. The camera detects the shooting conditions and switches to an appropriate scene mode.
4. Half press the Shutter button to focus the subject. The frame turns green to indicate focus is set.
5. Press the Shutter button to take the shot.



## Using Kids Mode

Tactically, kids are the most difficult to photograph. They tend to be highly animated and can be a real challenge to make them pay attention for more than just a second or two. To capture a great moment for your kids, just keep the camera in kid mode. The mode provides higher shutter speed and always focuses on moving subject.

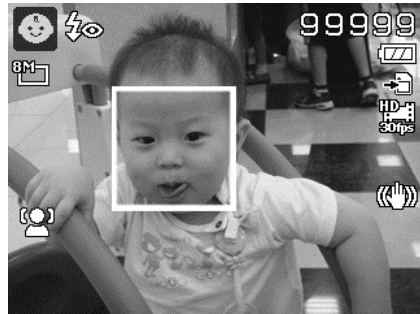

## Using Sports Mode

When you need a series of sports motion images, such as a golf swing, or try to capture the images of a flying hummingbird/butterfly, be sure to switch the scene mode to sports mode.

## Using Party Mode

Let the Party mode on! It can be difficult to get everyone on a party. While you have the whole gang together, take a group or family portrait. Party mode features on Red-eye reduction flash and face tracking. You'll miss fewer shots, and have more time to focus on enjoying the party.

## Using Food Mode

How to share your dining experiences and comments of interesting widgets on your blog by close-up images? Just get the camera and set the scene with food mode. This mode features on macro focus and auto flash designed for close-up photography.

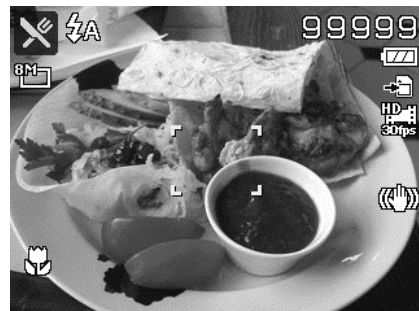

**Macro focus and Auto Flash are enabled by using Food mode.**

## Using Love Portrait

Want to take a good image when there are just two of you? All you have to do is hold the camera and show your smiles together.

If over two faces had been recognized, the camera performs 2-second countdown with a beep notice then take a shot without pressing the **Shutter button**.

## Using Self Portrait

When you are the one taking the picture for yourself, then self portrait mode is necessary besides the tripod. With your long arm's help, the camera begin face tracking in self portrait mode. If a face had been recognized, the camera performs 2-second countdown with a beep notice then take a shot without pressing the **Shutter button**.

Tips to make a great shape by self portrait photography:

- Lean in towards the camera to reduce double chin.
- Angle your body and bend your arms to look slimmer.
- Keep your shoulders back.

## Using Time Lapse

Use this feature to take photos automatically at the specified intervals. The photo size will be 16:9 (2M). In Time Lapse mode, press **Right** button to launch the Time Lapse menu, and then press **Up/Down** button to select the options.



Available options are 30 sec. (Default), 1 min., 5 min., 10 min., 30 min., 60 min. Press **OK** button to apply the setting and close the menu.

You can full press the Shutter button to start recording, and full press the Shutter button again to stop recording. The Time Lapse photos will be merged into a Time Lapse movie at 10 fps.

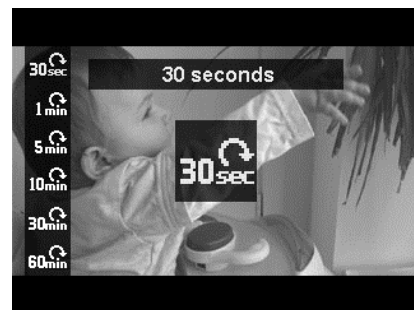

Photos taken from Time Lapse will be combined into a movie and will **NOT** exist individually in photo.

## Using Panorama Mode

Use this feature to create a panoramic photo from multiple shots. You can combine several shots into one single image quickly and easily.



- The actual size of stitched image may be different due to the panoramic angle and stitching result as well as the level of camera shaking.
- It is recommended to use a tripod to stabilize the camera, and then move the camera slowly during capturing.
- The longest time of capturing is approximately 30 seconds.
- If you select **From Top to Bottom** or **From Bottom to Top** in **360-degree** panorama, it is recommended to turn the camera over 90 degrees in order to make sure the stability during capturing.
- In Panorama mode, uneven brightness may result in difference between the captured image and its actual scene.

To stitch the still image

1. Press ▼ key to launch the **Angle Menu**. Use the ▲ or ▼ keys to select options. Press the **OK** button to save and apply changes.



2. Press ► key to launch the **Direction Menu**. Use the ◀ or ▶ keys to select options. Press the **OK** button to save and apply changes.



3. Full **press** the shutter button to start shooting. When shooting starts, a white-cross locates on the center and a yellow line displays horizontally (or vertically) through the screen. In addition, a shooting bar displays to present the shooting position and the white portion of the bar indicates where has been taken.
4. If **you** move camera without keeping straight, the yellow line will move with the moving scene.

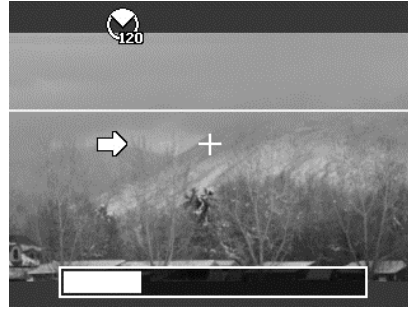
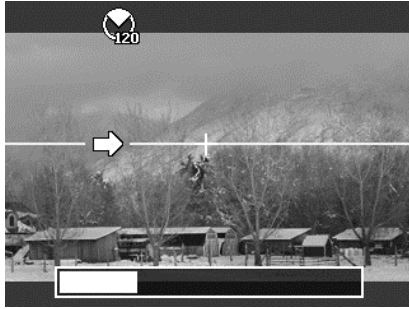

5. When the white portion of the bar goes to the end. The camera would finish automatically and save the panorama image.

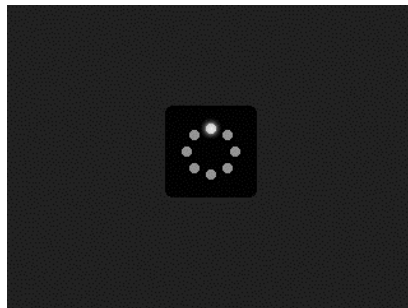





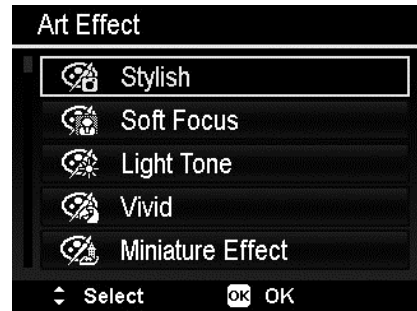



## Using Art Effect

Effect that cannot be presented on Preview does not apply to movie recording and continuous shooting.



Press ▲ or ▼ keys to select between the following settings:

Icon	Item	Description
	Stylish	This feature is used to capture images with over-saturated colors, off-kilter exposure or blurring.
	Soft Focus	Produces halo around the photographed object to achieve the effect of soft focus.
	Light Tone	Reduces contrast to create a smooth and relaxed atmosphere.
	Vivid	The camera captures the image with more contrast and saturation emphasizing on the bold colors.
	Miniature Effect	Blur the parts of photo to make the scene looks like a miniature scale model. It is recommended to capture from a high angle to simulate the miniature effect.
	Fisheye Lens	This feature captures images with fisheye lens effects.
	Astral	Image is applied with starburst.
	Poster	This feature captures images with old poster or illustration effects.
	Impressive Art	This feature captures images with dramatic contrast.

	B&W	Images are captured in black and white.
	Sepia	Images are captured in sepia tones.
	Color Accent (Red)	Retains red tone while the rest of the scene becomes black and white.
	Color Accent (Orange)	Retains orange tone while the rest of the scene becomes black and white.
	Color Accent (Yellow)	Retains yellow tone while the rest of the scene becomes black and white.
	Color Accent (Green)	Retains green tone while the rest of the scene becomes black and white.
	Color Accent (Blue)	Retains blue tone while the rest of the scene becomes black and white.
	Color Accent (Purple)	Retains purple tone while the rest of the scene becomes black and white.

## Using the Record Menu

If you are in Photo Mode, you can access the Record menu simply by pressing the **MENU button** on your camera.

When the menu is displayed, use the 4-way navigation control and the **OK** button to move through menu selections and apply your desired settings. To close the menu anytime, press the menu button again.

### Record Menu

The Record menu allows you to change modes, and setup other capture settings.

To go to Record Menu:

Turn on the camera by pressing **Power button**.

Press  to launch the Record Menu.

Use the **▲** or **▼** keys to move through the menu

To select an item, press **▶** or **OK** button.





Change the submenu settings using the 4-way navigation control.





Press the **OK** button to save and apply settings.





The table below shows the Photo Size values for still images.



Icon	Pixel Size	Printing Size Suggestion
	5152 x 3864	A2 Size
	3264 x 2448	A3 Size
	2592 x 1944	A4 Size
	2048 x 1536	4" x 6"
	640 x 480	E-mail

Icon	Pixel Size	Printing Size Suggestion
	5152 x 3435	Standard print paper
	5152 x 2898	HDTV
	1920 x 1080	HDTV
	2992 x 2992	Square Composition

## Quality

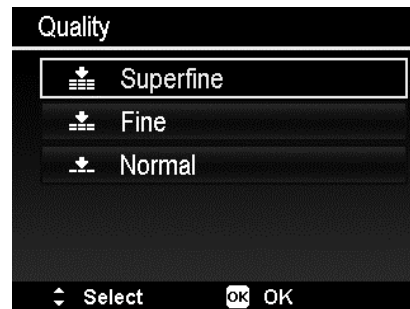
The Quality sets the quality (compression) at which the image is captured. The quality determines the amount of compression applied to your images. Fine quality would give you the best images with sharper details and less compression. However, the higher the quality, the more memory space is required in your memory card.









Icon	Item	Description
	Superfine	5x compression rate.
	Fine	8x compression rate.
	Normal	12x compression rate.

## White Balance

This sets the white balance for a variety of lighting conditions and permits images to be captured that approach the conditions that are seen by the human eye.

- As you move through the selection, you can see the preview on the LCD monitor synchronously.
- Press ► to enter **WB Shift**. This feature allows you to correct the white balance of **AWB** option.



Icon	Item	Description
	Auto White Balance	The camera automatically adjusts the white balance.
	Daylight	Ideally used for bright sunny conditions.
	Cloudy	Ideally used for cloudy conditions.
	Tungsten	Ideally used for indoor images with tungsten or halogen lighting without a flash.
	Fluorescent 1	Ideally used for indoor images with bluish fluorescent lighting conditions.
	Fluorescent 2	Ideally used for indoor images with reddish fluorescent lighting conditions.
	Custom	Used when light source cannot be specified. Press ► for the camera to automatically adjust the appropriate white balance setting according to the environment.

## ISO

This sets the sensitivity for capturing images. When the sensitivity is raised (and the ISO figure is increased), photography will become possible even in dark locations, but the more pixelated (grainier) the image will appear.

- Use a higher ISO setting in dim conditions and a lower ISO setting in brighter conditions.

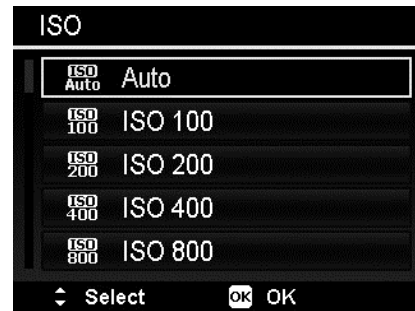

## Maximum ISO Auto



This feature allows the camera to adjust the ISO Auto from ISO 100 to the value set in Maximum sensitivity, according to light conditions. Available options are 200, 400, 800 (Default).

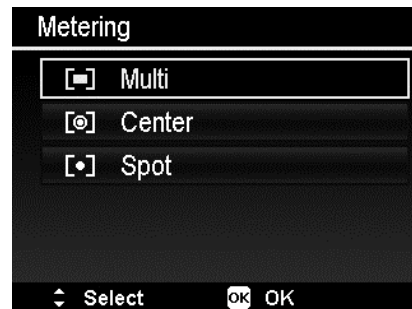

## Metering

This sets the metering method for calculating the exposure.



Icon	Item	Description
	Multi	The entire area of the screen is measured, and the exposure is calculated.
	Center	Averages the light metered from the entire frame, but gives greater weight to the subject matter at the center.
	Spot	A very small portion of the center of the screen is measured, and the exposure is calculated.

## Setting the Exposure Bracketing

Use this feature to take photos with different exposure compensation. Bracketing records 3 continuous images in the following order: Standard exposure, Underexposure and Overexposure.

Available settings are: Off,  $\pm 0.3$ ,  $\pm 0.7$  and  $\pm 1.0$ .

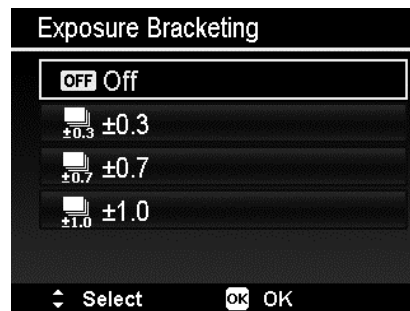

## Setting the AE-L/AF-L

This feature allows locking exposure or focus or both of them by pressing AE/AF LOCK button. You can define the AE/AF LOCK button to be one of the following functions:

- AE-L: Lock/Unlock exposure.
- AF-L: Lock/Unlock focus.
- AE-L & AF-L: Lock/Unlock both of exposure and focus.

Press the AE/AF LOCK button to unlock it.

To lock AE/AF, press the AE/AF LOCK button during movie recording or half press the shutter button then press the AE/AF LOCK button in Photo mode.



Show this function only when use Program mode.

## Setting the Digital Zoom

This feature controls the digital zoom mode of your camera.



Your camera enlarges an image using the optical zoom first. When the zoom scale exceeds 5x, the camera uses digital zoom.

To set Digital Zoom

1. From the Record menu, select **Digital Zoom**.
2. Use the ▲ or ▼ keys to go through the selection.
3. Press the **OK** button to save and apply changes.

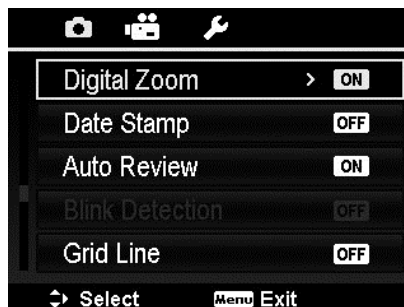
The table below shows the available Digital Zoom settings.



Icon	Item	Description
	On	Enlarges all image sizes, but the image quality deteriorates.
	Off	Uses the optical zoom only.



Digital Zoom is not available in Face Tracking on.

## Setting the Date Stamp

The date of recording can be printed directly on the still images. This function must be activated before the image is captured. Once date and time are stamped on an image, they can no longer be edited or deleted.

Limitations of Date Stamp functions are as follows:

- Available for still images only.
- This feature does not apply to continuous shooting mode.
- In vertical or rotated images, the date and time on your images still appear horizontally.

To set Date Stamp

1. From the Record menu, select **Date Stamp**.
2. Use the ▲ or ▼ keys to go through the selection.
3. Press the **OK** button to save and apply changes.



## Setting Auto Review

The Auto Review function lets you view the captured image right after shooting it.

If Auto review is On, the camera will display the captured image for **1 second** on the LCD monitor.

To set Auto Review

1. From the Record menu, select **Auto Review**.
2. Use the ▲ or ▼ keys to go through the selection.
3. Press the **OK** button to save and apply changes.



## Blink Detection

Nothing ruins a great picture more than having your subjects' eyes closed. Blink Detection provides you with extra assurance when capturing once-in-a-lifetime moments like holding a trophy with teammates after winning a basketball game.

If closed eyes are detected, a saving confirmation menu appears on the screen,

allowing you to re-take the shot before your subject or subjects move on.

To activate Blink Detection

1. Enable Blink Detection from Record menu.
2. Half press the **Shutter button** to focus the subject. The frame turns green to indicate focus is set.
3. Press the **Shutter button** to capture the image and automatically save the Image.
4. If the camera detects subject blinked eye, a "**Save image**" or "**Cancel**" option appears on the screen.
5. Select **Save image** to save or **Cancel** to disregard

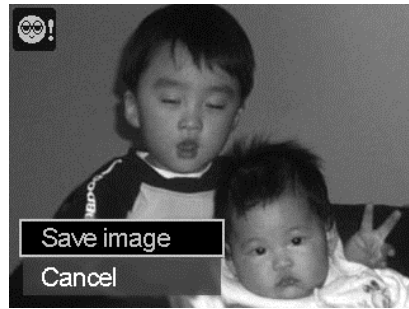

Blink Detection appears in Record menu only when Face Tracking is turned on

## Setting Grid Line

The Grid Line function will show a framing grid on preview for taking pictures. Available settings are: **On**, **Off**.

The configuration of Grid Line will be changed with different aspect ratio.

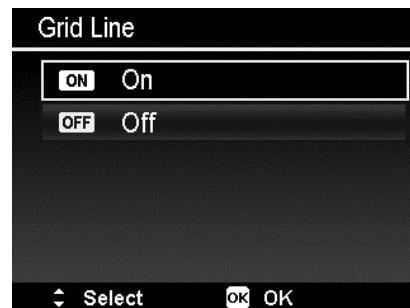

## Setting Stabilizer

This function allows you to prevent blurred images caused by shaking.

1. Enable the Stabilizer under the Record Menu.
2. Use the ▲ or ▼ keys to go through the selection.
3. Press the OK button to save and apply changes.

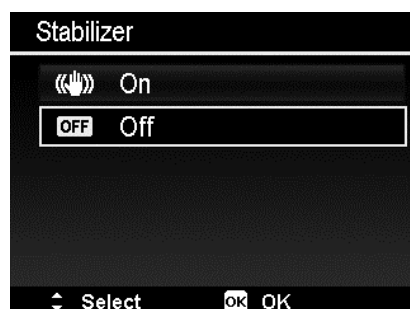

# Playback

You can playback the still images, video clips on the LCD monitor.

## Viewing in Single Navigation

The Single navigation mode displays the image one by one on the LCD monitor. To view images/video clips, follow the steps below.

1. Press the **Playback button**  on the camera.
2. The LCD monitor displays an image. To understand the icons and other information on the screen, please see "Photo Mode Screen Layout" on page 19.

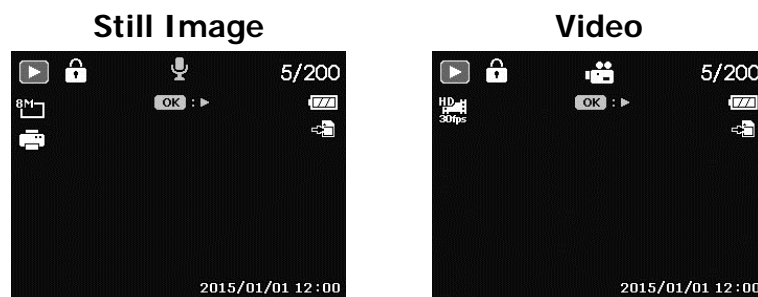

3. Use the ◀ or ▶ keys to view next/previous image/video.
4. To play a video clip, press the **OK** button. See "Playing Videos" on page 58 for more details.



When playing videos under playback mode, lens will retract after 15 seconds, but the video playback will still continue.

## Viewing Thumbnails

This function allows you to view 9 or 36 thumbnail images on the LCD monitor at the same time. Searching numerous of images is much easier than single view navigation.

To set 9-images or 36-images mode

1. Press the Playback button  on the camera.
2. Press the Zoom button (left) once to enter 9-images mode or twice to enter 36-images mode.
3. Use the navigation controls to move through the items.
4. Press the OK button to select the image and view it normally.



### Scroll bar.

If scroll bars appear, it indicates that the screen can be scrolled. It can be displayed 9 images (3x3) or 36 images (6x6) at one time in Thumbnail Screen. Use the **4-way navigation control** to select the file and press the **OK button** to display the selected file in Single Navigation.

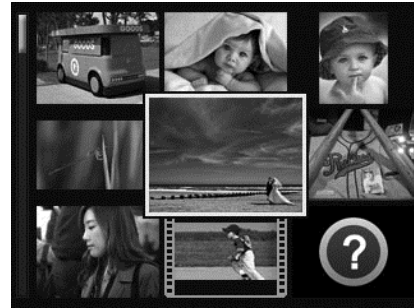



Thumbnail 3x3



Thumbnail 6x6

### Thumbnail icons:

When you view the thumbnails, some images may contain icons. These icons indicate the type of file or recording.

Icon	Type	Description
	File Error	Indicates an error file.
	Video	Displays a indicate videos by roll film pattern.



### Magnify

The zoom view function works with still images only.

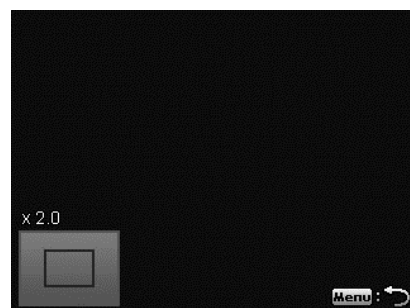
- In normal view, press the **Zoom button** (right) repeatedly until the desired zoom view.
- You can zoom to view an image of up to 12X.
- Use the navigation controls to view the zoomed image.
- Press the **Menu** button from any magnify ratio to return to Single Navigation.



## Playing Videos



1. Press the **Playback button**  on the camera.
2. Use the navigation controls to scroll through the saved images. A video clip has a video icon displayed on screen.
3. Press the **OK** button to play the video.
4. During playback, press and hold the ◀ or ▶ keys to fast forward or rewind the video. The camera supports forward and rewind speed of up to 4x.
5. During playback, use the **Zoom buttons** to control volume. Press the right button to increase volume/Press the left button to decrease volume.
6. Press the ▲ key to pause playback. Press the key ▲ again to resume. When paused, the play info will remain on screen except **WT** .
7. To forward or rewind the video frame by frame, press the key ▲ to pause playback, then press the ◀ or ▶ keys.
8. Press the ▼ key to stop the playback. The LCD monitor displays the video frame image in Single navigation mode.



- The play info, except the icon **WT** , will be displayed when the video is paused, during REW/FF or frame by frame modes
- Volume cannot be adjusted when paused or during REW/FF modes.

## Playing Voice Memo

Voice memo is separately recorded and attached to a captured image. See "Voice Memo" on page 63 on how to record voice memo.

1. Press the **Playback button**  on the camera.
2. Use the navigation controls to scroll through the saved images. An image file with voice memo has a voice memo icon located on the top center of the LCD monitor. See picture on the right.
3. Press the OK button to play the voice recording.
4. During playback, use the **Zoom buttons** to control volume. Press the right button to increase volume/Press the left button to decrease volume.
5. Press the key **▲** to pause playback. Press the key **▲** again to resume. When paused, the play info will remain on screen except  .
6. Press the key **▼** to stop the playback. The LCD monitor displays the image in Single navigation mode.



Volume cannot be adjusted when you pause the voice memo.

## Playback Menu

The Playback menu allows you to edit images, record voice memo, and setup playback settings.

To go to Playback Menu:

1. Press the **Playback button**  on the camera.
2. Press **Menu button** to launch the Playback Menu.
3. Use the ▲ or ▼ keys to move through the menu selections.
4. To select a menu, press ► or the **OK** button.
5. Change the submenu settings using the 4-way navigation control.
6. Press the **OK** button to save and apply settings.

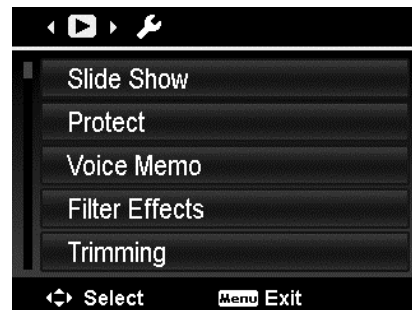

## Slide Show

The slide show function enables you to playback your photos, videos and error files according to naming order.

To view Slide Show:

1. From the Playback menu, select **Slide Show**. The Slide Show menu appears.
2. Set the slide show settings.
3. Select **Start**, then press the **OK** button to start the slide show.
4. During Slide Show, press the **UP** button to pause slide show.
5. Use the ▲ or ▼ keys to move through the options. Select whether to **Continue** or **Exit** the slide show.
6. Press the **OK** button to apply selected option.

To change slide show settings:

1. From the Slide show menu, use the ▲ or ▼ keys to move through the selections.
2. Select Interval setting. Press the ◀ or ▶ keys to adjust. Choose among the available interval settings: 1 sec., 3 sec., 5 sec., and 10 sec.
3. Select Repeat setting. Press the ◀ or ▶ keys to adjust. Available settings are: Yes, No.

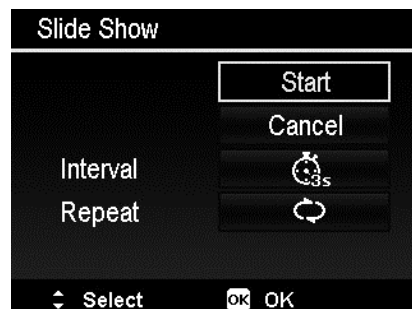

## Protect

Set the data to read-only to prevent images from being erased by mistake.

A protected file has a lock icon  when viewed on Playback mode.

To protect files:

1. From the Playback menu, select **Protect**.
2. The Protect submenu is displayed on the LCD monitor.

Available select settings:

- **Single**. Select one file to lock/unlock.
- **Multi**. Select multiple files from the thumbnail view to lock/unlock.
- **Lock all**. Lock all files
- **Unlock all**. Unlock all files.

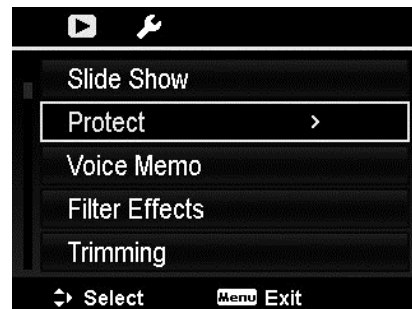

To protect/unprotect a single file:

1. Select **Single** in the Protect submenu, the images are displayed on the LCD monitor in single navigation mode.
2. Use ◀ or ▶ keys to scroll the display.
3. When the desired file is displayed on the LCD monitor, press the **OK** button to select **Lock/Unlock**.
4. To close the protect/unprotect function and go back Playback menu, select **Exit**.

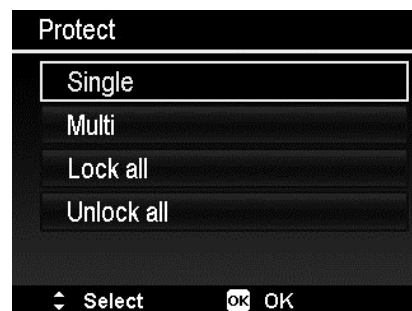

To protect/unprotect multiple files:

1. Select Multi in the Protect submenu, the images are displayed in thumbnail view on the LCD monitor.
2. Use the ◀ or ▶ keys to move through the files.
3. When the desired file is highlighted, use the ▲ or ▼ keys to mark/unmark the file for protection.
4. Repeat step 3 until all desired files to protect are marked.
5. Press the **OK** button to lock files and go back to Playback menu.

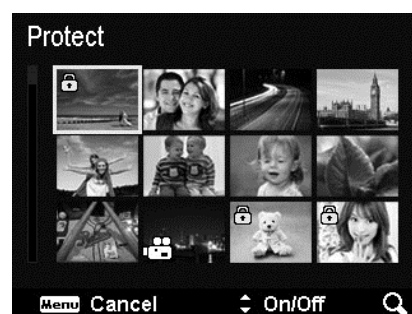

To protect all files:

1. Select **Lock all** in the Protect submenu. A confirmation message appears.
2. Select **Yes**.
3. Press the **OK** button to lock all files.

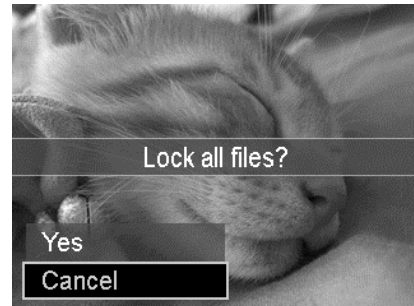

To unlock all files:

1. Select **Unlock all** in the Protect submenu. A confirmation message appears.
2. Select **Yes**.
3. Press the **OK** button to unlock all protected files.

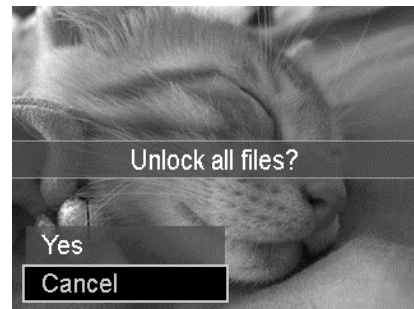

## Voice Memo

A maximum of 30 seconds of audio can be recorded as a memo for captured still images.

To record voice memo:

1. Press the **Playback button**  on the camera.
2. Press the ◀ or ▶ keys to scroll and select an image to attach voice memo to.
3. Press the **MENU** button to launch the Playback menu.
4. Select **Voice Memo**.
5. Select **Start**, then press the **OK** button to start recording.
6. Press the **OK** button again to stop recording.

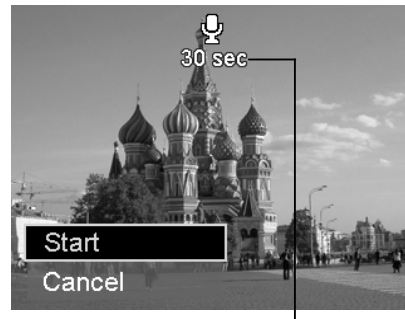
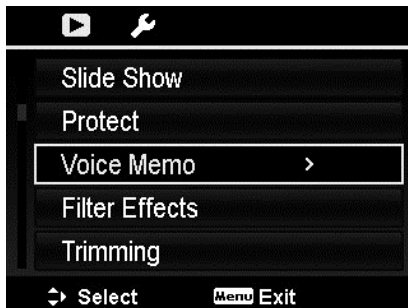

**Time left (n seconds) for recording.**



When you record voice memo to an image with an existing voice memo, the old recording file would be replaced by the new one.

## Filter Effects

Filter Effects function is only applicable to aspect ratio **4:3** photos with different artistic effect. Edited images in this function are saved as new files.

To activate Filter Effects:

1. Press the Playback button  on the camera.
2. Press the ◀ or ▶ keys to scroll and select an image to edit.
3. Press the **MENU** button to launch the Playback menu.
4. Select **Filter Effects**. The Filter Effects submenu appears.

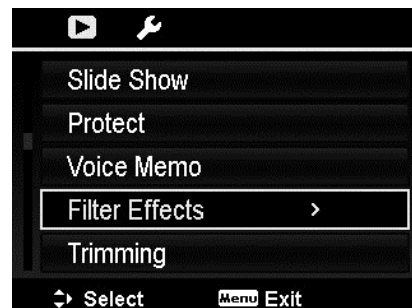

5. Press the ▲ or ▼ keys to scroll and **OK** button to select an option.

The succeeding table shows the available settings.

<b>Item</b>	<b>Description</b>
<b>Soft</b>	Image is applied with soft effect.
<b>Color Emphasis</b>	Retains the color tone you choose while the rest of the scene becomes black and white.
<b>Vivid</b>	Image is applied with more contrast and saturation emphasizing on the bold colors.
<b>Miniature Effect</b>	The parts of image will be blurred and make the scene looks like a miniature scale model. It is recommended to apply the image that captured from a high angle to simulate the miniature effect.
<b>Astral</b>	Image is applied with starburst.
<b>Impressive Art</b>	Image is applied with dramatic contrast.
<b>Painting</b>	Image is applied with watercolor effect. Please note that if one image is applied with Painting function already, it cannot be applied with Astral again.
<b>Negative</b>	Image appears to be the opposite of the original image.
<b>B&amp;W</b>	Image is applied with black and white.
<b>Mosaic</b>	Image is applied with mosaic tiles.
<b>Sepia</b>	Image is applied with sepia tones.



## Trimming

The Trim function allows you to trim an image to another image size. This function is only available for still images.

To trim an image:

1. Press the Playback button  on the camera.
2. Press the ◀ or ▶ keys to scroll and select an image to trim.
3. Press the **MENU** button to launch the Playback menu.
4. Select **Trimming**. The Trim screen layout is displayed on the LCD monitor.
5. Use the **Zoom** button to change the trimming frame as zoom in/out.



No.	Description
1	Enlarged image
2	4-way indicator
3	Trimmed size
4	The approx. location of the trimmed area
5	Image area



6. Use the navigation controls to move the image.
  7. Press the **OK** button to apply changes. A menu selection appears.
  8. Select whether to:
    - **Yes**. Save the new file as a new one.
    - **Cancel**. Cancel setting and back to Playback Menu.
  9. Press the **OK** button to save/cancel changes.
-  • Trim function is not available for images with image size set to VGA.
  - All images will be trimmed in 4:3 ratio regardless of its original image ratio.



## Resize

Resizes a previously saved image to create a small copy photo and only resizing to a smaller size is available.

To resize an image:

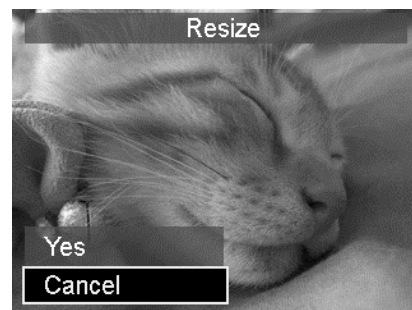
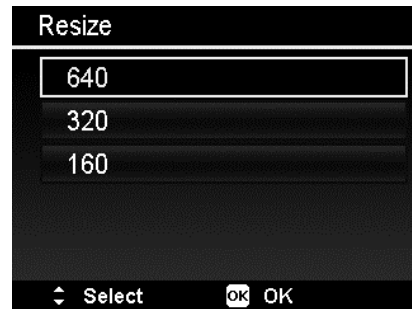
1. Press the **Playback button**  on the camera.
2. Use the ◀ or ▶ keys to scroll and select an image to resize.
3. Press the **MENU** button to launch the Playback menu.
4. Select **Resize**. The Resize submenu is displayed on the LCD monitor.
5. Select size among: 640, 320, and 160.
6. After selecting size, a menu selection appears.
7. Press the **OK** button to save/cancel changes.
8. The resized image is saved as a new photo.





-  • Resize function is only applicable to aspect ratio 4:3 photos.
-  • The original photos can be resized more than once. However, each resized photo cannot be resized again.

## Startup Image

You can specify the startup image from the captured images for camera.

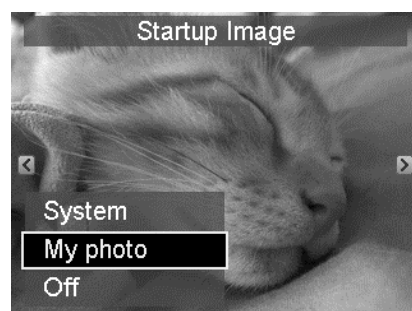
1. Press the **MENU** button to launch the Playback menu.
2. Select **Startup Image**. The menu selection appears.
3. Select options:
  - **System**. Use camera default image.
  - **My Photo**. Use the ◀ or ▶ keys to scroll and select desired image.
  - **Off**. Disable the startup image.
4. Press the **OK** button to apply changes.



-  The startup image will still be displayed startup even if the selected image was deleted.

## DPOF

DPOF is the abbreviation for Digital Print Order Format, which allows you to embed printing information on your memory card. You can select the images to be printed and how many prints to make with the DPOF menu in the camera and insert the memory card to the card compatible printer. When the printer starts printing, it will read the embedded information on the memory card and print the specified images.

To set DPOF:

1. Press the **Playback button**  on the camera.
2. Press **Menu button** to launch the Playback Menu.
3. Select **DPOF**. The submenu appears.  
Available settings are as follows:
  - **Select Images**. Mark images in the memory card.
  - **Reset**. Reset all DPOF settings to initial default settings.

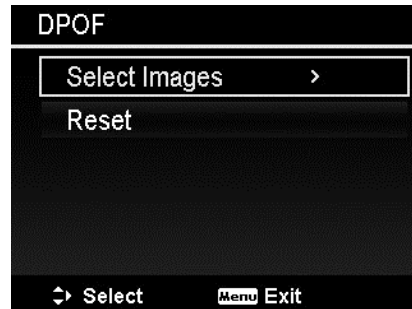

To set DPOF on images:

1. Select **Select Images** on the DPOF submenu.
2. Use the ◀ or ▶ keys to scroll and select images to mark for printing.
3. When the desired image is highlighted, use the ▲ or ▼ to increase/decrease number.
4. Press the **OK** button to define the DPOF settings and select **Done** to save DPOF settings.

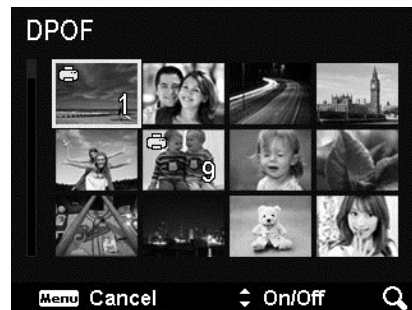

To reset DPOF:

1. Select **Reset** on the DPOF submenu.
2. The camera auto reset all DPOF settings.



## Copy

Use this feature to copy images between internal memory and memory card.

To copy images between internal memory and memory card:

1. Press the **Playback button**  on the camera.
2. Press **Menu button** to launch the Playback Menu.
3. Select **Copy** and choose a method you want to copy images to. After choosing, available settings are as follows:
  - **Selected images.** Select images to the storage device you prefer.
  - **All images.** Copy all images to the storage device you prefer.

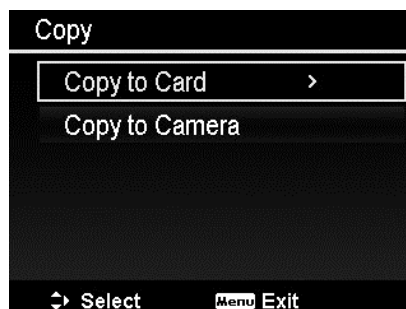

To copy selected images:

1. Select **Selected images** on the Copy submenu.
2. Use the ◀ or ▶ keys to scroll and select images to mark for Copying.
3. When the desired image is highlighted, use the ▲ or ▼ keys to mark/unmark the file for copying.
4. Press the **OK** button and select **Yes** to start copying.



To copy all images:

1. Select **All images** on the Copy submenu.
2. Select **Yes** to start copying.

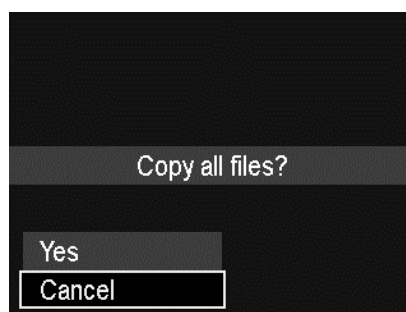

If no memory card or a locked card is inserted, this option would be gray.

## Movie Paste

Use this feature to combine two videos with the same specification (movie size and fps) into one video.

To combine two videos:

1. Press the **Playback button**  on the camera.
2. Use the ◀ or ▶ keys to scroll and select the original video.
3. Press the **MENU** button to launch the Playback menu.
4. Select **Movie Paste**. The videos with the same specification as the original video are displayed on the LCD monitor.
5. Use the ◀ or ▶ keys to scroll and the ▲ or ▼ keys to mark/unmark the second video.
6. Press the **OK** button and select **Yes** to merge it to the end of the original video and overwrite it.

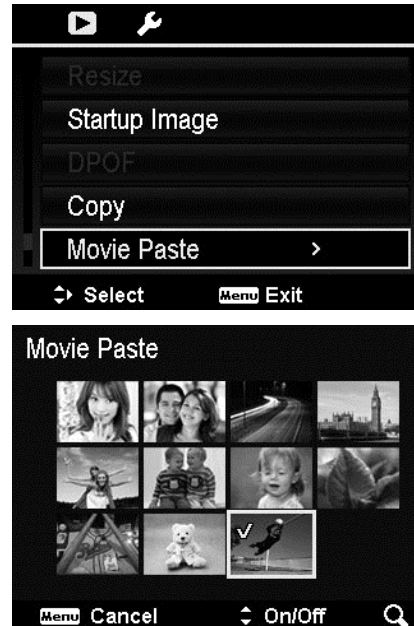

- The total length of the combined video cannot be over 30 minutes.
- After combining videos, the second video will no longer exist with a separate file.

## Face Retouch

This function is only applicable to still images that captured with Face Tracking.

When enter the Face Retouch menu, locate the cursor on the picture if it has over two faces, or locate the cursor on function at the right side of the menu if only one face on the picture.

Only one face can be retouched each time. All function will be reset to 0 when exit from Face Retouch menu, no matter save the picture or cancel the setting.

Pictures that have been performed Face Retouch will be saved as a new image and can be performed this function again.



Item	Available Settings	Description
<b>Smoothing</b>	0-3	The Smoothing level are 0-3.
<b>Brighten</b>	0-3	The Brighten level are 0-3.
<b>Enlarge Eyes</b>	0-3	The Enlarge Eyes level are 0-3.
<b>Save</b>	N/A	Save the image.

## Using the Setup Menu

You can access the Setup menu whether you are in Record or Playback mode. The Setup menu allows to configure general camera settings.

To go to Setup Menu:

1. Press **Menu** button to launch the Record/Playback Menu.
2. Use the ◀ or ▶ keys to switch the menu tab to **Setup** menu.
3. Use the ▼ or ▲ keys to move through the menu selections.
4. To select an item, press the **OK** button or ▶ key.
5. Change the submenu settings using the 4-way navigation control.
6. Press the **OK** button to save and apply settings.

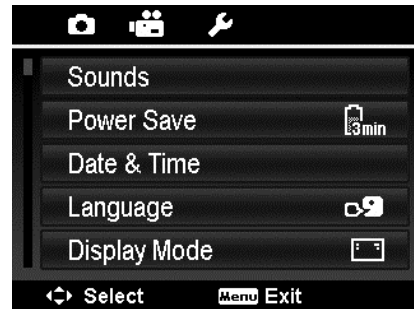

## Setting Sounds

Use the Sound menu functions to control the sounds produced by the camera.

1. From the Setup menu, select **Sounds**.
2. Adjusts sound settings.
3. Press the **OK** button to apply changes.



Item	Available Settings	Description
<b>Startup</b>	Sound 1, Sound 2, Sound 3, Off	Selects the startup sound when camera is turned on.
<b>Shutter</b>	On, Off	Enables or disables shutter sound when Shutter button is pressed. Shutter sound is not available when recording videos.
<b>Beep volume</b>	0-4	Adjusts volume.

## Setting Power Save

The Power Save function allows you to set an idle time after which the camera automatically sets to sleep mode to save power. After a minute of being in sleep mode, the camera eventually turns off power.

This function is not available in the following instances:

- Recording a video file
- Playing a Slide Show/video file
- Using the USB connector
- AE/AF has been locked
- During Movie Paste
- During interval time on Time Lapse

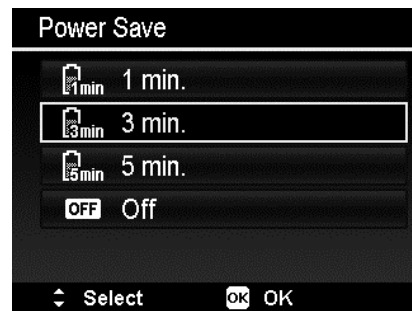

## Setting Date & Time

Use the Date & Time function to set the date and time of your camera. This function is useful in attaching date stamps on captured images. Your camera uses a 24-hour time format.

1. Press the navigation controls to adjust date and time value. By holding down the ▼ or ▲ keys, the numeric values changes continuously.
2. Press the **OK** button to apply changes.





## Setting Language

Specify in which language menus and messages are to be displayed on the LCD monitor.

1. Use the navigation control to scroll through the list and select the desired language.
2. Press the **OK** button to confirm and apply settings.



## Setting Display Mode

This function controls the icon display on LCD monitor for both Record mode and Playback mode.

Available settings are: On, Detailed Info, Off.

If set Display Mode to Off, the mode icon and remaining shots will display for 2 seconds in following situations:

- Power on the camera
- Switch from Playback to Record mode
- After shooting
- Close the menu and back to preview

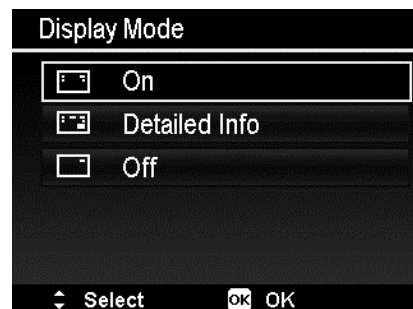

## Setting TV Out

Use the TV Out function to adjust video output signal to accommodate different regional settings. If TV out is not set correctly, the image may not display properly on TV.

Available settings are:

- **NTSC**. Applicable in Japan, USA, Canada, Taiwan and others.
- **PAL**. Applicable in Europe, Asia (excluding Taiwan), Oceania and others.

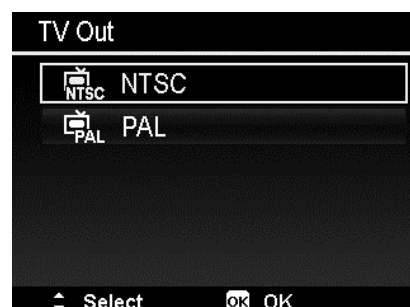

## Setting LCD Brightness

Select a brightness level for the LCD monitor.

Available settings are:

- **Auto.** Auto detects the LCD brightness.
- **Bright.** Enhance the LCD brightness.
- **Normal.** Normal LCD brightness.

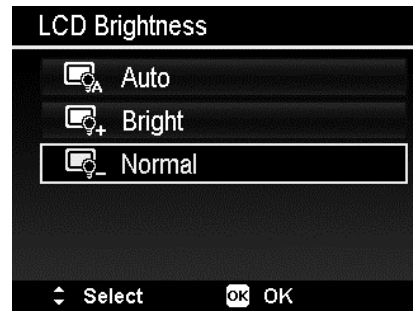

## Setting Format

This utility formats current used memory (Internal memory or Memory card) and erases all stored images and data.

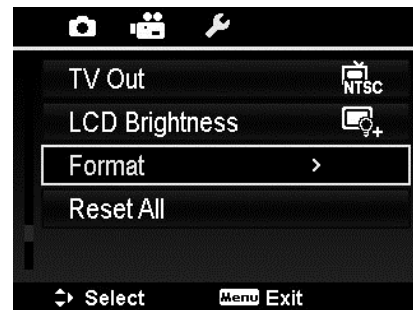

If a locked card has been inserted, the option would be gray.

## Reset All

Use this function to reset the camera to its factory settings. However, the following settings are exceptions and not affected by Reset.

- Date & Time
- Language
- TV Settings
- Custom White Balance data

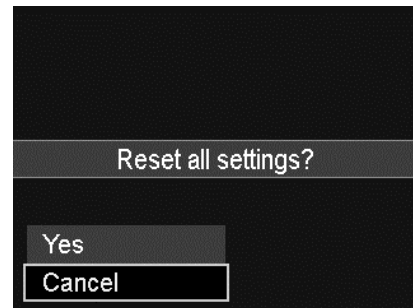

# Making Connections

You can connect your camera to: TV, computer, or a printer.

## Connecting the Camera to a TV

You can play back your images on a TV screen. Before connecting to any video devices, make sure to select NTSC/PAL to match the broadcast standard of the video equipment you are going to connect to the camera.

To connect your camera to a TV:

1. Turn on the camera.
2. Set the TV out to match the TV's video out format. See "Setting TV Out" on page 73.
3. Connect the USB/AV 2-in-1 cable to the USB port on the bottom of your camera.
4. Connect the other end of the cable to the TV's AV input port.
5. The LCD monitor turns black and all images and video clips are displayed on the TV.

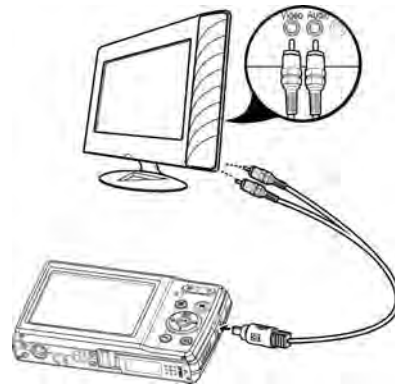

## Connecting the Camera to a PC

You can transfer images and video files to your PC.

1. Connect one end of the USB cable to an available USB port on your computer
2. Connect the other end of the USB cable to the USB terminal on the camera.
3. Turn on the camera.
4. The PC starts to detect the connection while the LCD monitor appears **Connecting...**

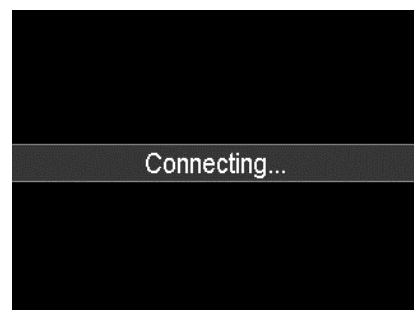
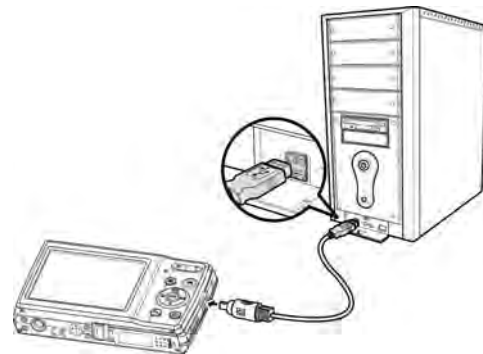

5. Connection established and the LCD monitor will be turned off.
6. Access the files in the camera by your PC.



- The camera's internal memory and memory card would display as removable drives in Vista/Win7/Win8 PC.
- When this camera is connected to your PC, two removable drives will display. Please click AP link (Magix) in the second drive, and then Setup window will display (an Internet connection is required). After installation, you can import / edit your photos, movies and music. Please note that AP link (Magix) is the trial version and will be used permanently after registration.

## Connecting the Camera to a Printer

You can print your images directly using a **PictBridge compatible** printer.

1. Turn on your Printer. Check that the printer is turned on, there is paper in the printer, and there are no printer error messages.
2. Connect one end of the USB cable to the printer while the other end to USB terminal on the camera.
3. Enter the print mode and print the selected images.

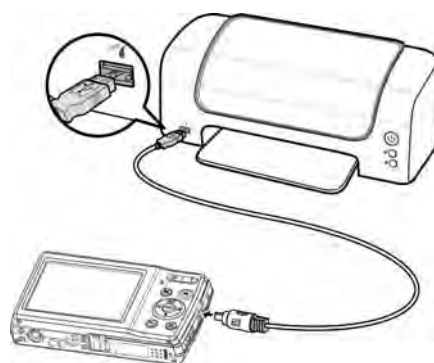

For details on the following page "Setting the Print Mode Menu".

## Setting the Print Mode Menu

Print Mode menu appears on the screen after the connection between a printer and your camera is established.

Print Mode includes three major settings:

- **Print Select.** An image can then be selected to print.
- **Print All.** Prints all images.
- **Print DPOF.** Prints the images which are set DPOF.

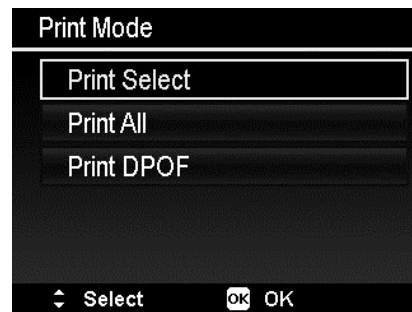

To set Print Select

1. Use the ◀ or ▶ keys to scroll and select an image for printing.
2. Specify the number of copies. Use the ▲ or ▼ key to increase/decrease number.
3. Press the **OK** button to enter printer settings.

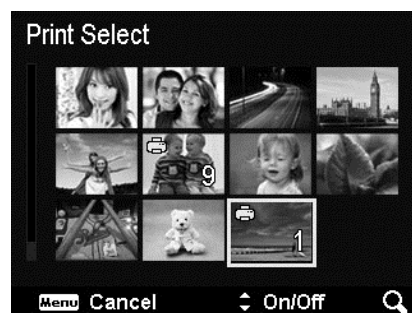

To set Print All and Print DPOF

Repeat the same steps 1 to 2, then enter printer settings.

To set Printer Settings

1. Use the ▲ or ▼ key to specify a print option.
2. Modify paper size, quality, date and info by the ◀ or ▶ keys. Available setting:
  - Paper size: Default / A4 / 4"x6"
  - Quality: Default / Fine / Normal
  - Capture Date: Yes / No
  - Capture Info: Yes / No
3. Select **Print** on the screen for printing.  
Or **Cancel** to go back Print Mode.

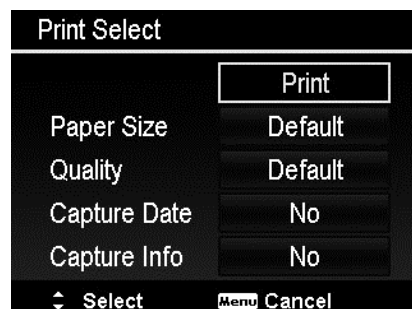

Start Printing

- LCD monitor appears "Now printing...".
- Or press Menu button to stop printing anytime.

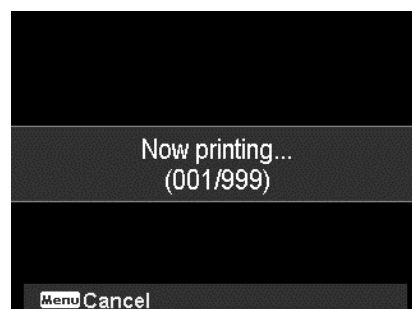

# Appendix

## About Folder and File Names

Your camera automatically creates specific directory of folder in the internal memory cards to organize captured image and video files.

### File Naming

File names begin with "DSCI" and followed by a 4-digit number that increases in sequence. File numbering starts from 0001 when a new folder is created.

The highest file number is 9999, if exceeds 9999, the camera will start over the file number from 0001.



Do not change the folder and file names in the memory card using your PC. It may be unable to playback the data using the camera.

## Troubleshooting

Problem	Cause and/or Action
Camera does not turn on.	The batteries may be exhausted. Charge or replace the batteries.
Camera turns off automatically.	<ul style="list-style-type: none"><li>• Power Saving may have activated. Turn power back on.</li><li>• The battery may be exhausted. Charge the battery.</li></ul>
Empty battery icon is displayed on the LCD, then the camera turns off.	Batteries are exhausted, please replace or recharge.
LCD monitor displays "Not available for this file".	Function is only available for specific file types. File format is not supported.
LCD monitor displays "Memory full".	Memory card is full. Replace the memory card with a new one or delete unnecessary images.
LCD monitor displays "File locked".	This file is locked. Unlock the file. See "Protect" on page 61.

<b>Problem</b>	<b>Cause and/or Action</b>
<b>LCD monitor displays "Card locked".</b>	The memory card is protected. Remove the card and slide the write-protect switch to its unlock position.
<b>LCD monitor displays "Card error".</b>	Memory card may be format is not supported by the camera. Please go to Setup menu to format the card.
<b>LCD monitor displays "Memory card is damaged".</b>	The card may be damaged. You can either change the card or wipe to clean the connected points.
<b>LCD monitor displays "Copy error".</b>	The memory card is protected. Remove the card and slide the write-protect switch to its unlock position. The memory card is full. Replace card or delete unnecessary files.
<b>No image displays on the TV screen.</b>	Incorrect TV-out type was selected. Set the correct TV-out type to match your TV system.
<b>The lens got stuck up.</b>	Do not force the lens to go back. The type of the battery used may be incorrect or the battery power level is too low. Change the battery or charge the battery before using the camera.

## Specifications

<b>Sensor</b>	20M Pixels
<b>Lens</b>	Focal Length: 26 mm ~ 130 mm 5x optical zoom, 8x digital zoom
<b>LCD monitor</b>	2.7" Color LCD
<b>Focusing Range</b>	Normal: Wide: 5 cm ~ infinity Tele: 60 cm ~ infinity Macro: Wide: 5 cm ~ 100 cm Tele: 150 cm ~ 200 cm Super Macro: Wide: 3 cm
<b>Aperture</b>	Wide: F3.2; Tele: F6.4
<b>Shutter</b>	Shutter Speed: Auto: 1 - 1/2,000 sec. Manual: 15 - 1/2,000 sec. Night: 1/4 - 1/2,000 sec. Fireworks: 4 sec.
<b>File Format</b>	Still Image: EXIF 2.3 compatible format (JPEG compression) AVI (Video: MJPEG , Audio: mono) Audio: WAV
<b>Resolution (Photo)</b>	Aspect ratio 4:3 20M (5152 x 3864), 8M (3264 x 2448), 5M (2592 x 1944), 3M (2048 x 1536), VGA (640 x 480) Aspect ratio 3:2 5152 X 3435 Aspect ratio 16:9 14M (5152 x 2898), 2M (1920 x 1080) Aspect ratio 1:1 2992 x 2992



<b>Resolution (Movie)</b>	<ul style="list-style-type: none"> <li>• 720p30</li> <li>• VGAp30</li> </ul>
<b>Scene Mode</b>	Intelligent Scene, Program, Portrait, Landscape, Sunset, Backlight, Kids, Night Scene, Fireworks, Snow, Sports, Party, Candlelight, Night Portrait, Soft Skin, Flowing Water, Food, Love Portrait, Self Portrait, D-Lighting, Time Lapse, Panorama, Art Effect
<b>ISO Equivalent</b>	Auto, ISO 100, ISO 200, ISO 400, ISO 800, ISO 1600, ISO 3200, ISO 6400
<b>Maximum ISO Auto</b>	ISO 200, ISO 400, ISO 800
<b>White Balance</b>	Auto White Balance, Daylight, Cloudy, Tungsten, Fluorescent 1, Fluorescent 2, Custom
<b>Exposure Control</b>	+2.0EV / +1.7EV / +1.3EV / +1.0EV / +0.7EV / +0.3EV / 0EV / -0.3EV / -0.7EV / -1.0EV / -1.3EV / -1.7EV / -2.0EV
<b>Metering</b>	Multi, Center, Spot
<b>Self-timer</b>	Off, 10 sec., 2 sec., Double
<b>Flash</b>	Auto Flash, Red-eye Reduction, Forced On, Slow Sync, Forced Off
<b>Storage</b>	Internal memory: 64MB flash memory External memory: SD (up to 4GB), SDHC card (up to 32GB guaranteed), SDXC card (up to 64GB guaranteed)
<b>OSD Language</b>	English, Français, Español, Deutsch, Italiano, Русский, Português, Português BR, Nederlands, Türkçe, Polski, Magyar, Română, Čeština, Български, Hrvatski, Slovensky, Slovenščina, Ελληνικά, Svenska, Norsk, Suomi, Danish, عربي, Indonesia, Malay, ไทย, 日本語, 한국어, 简体中文, 繁體中文
<b>Interface</b>	USB/AV OUT
<b>TV system</b>	NTSC/PAL (selected by Setup MENU)
<b>Battery</b>	Lithium ion battery
<b>Battery Level</b>	Full-Half (65% ± 15%) Half-Low (25% ± 15%) Low-Exhausted (10% ± 10%)
<b>USB adapter</b>	Rated input voltage: AC 100V-240V (160mA, 50/60Hz)

	Rated output voltage: DC 5V/1A Operating temperature: 0°C - 40°C
<b>Operating Temperature</b>	0°C - 40°C
<b>Operating Humidity</b>	0% - 90%
<b>Microphone</b>	Built-in
<b>Speaker</b>	Built-in
<b>Dimensions</b>	100.39 x 59.00 x 21.45 (mm)
<b>Weight</b>	103 g (no battery)

## Disposal



**Dispose of packaging:** For disposal, separate packaging into different types. Cardboard and board must be disposed of as paper and foil must be recycled.



### **Disposal of Waste Electrical and Electronic Equipment and/or Battery by users in private households in the European Union.**



This symbol on the product or on the packaging indicates that this cannot be disposed of as a household waste. You must dispose of your waste equipment and/or battery by handing it over to the applicable take-back scheme for the recycling of electrical and electronic equipment and/or battery. For more information about recycling of this equipment and/or battery, please contact your city office, the shop where you purchased the equipment or your household waste disposal service. The recycling of materials will help to conserve natural resources and ensure that it is recycled in a manner that protects human health and environment.

### **Battery warning**

- Never dismantle, crush, or pierce the battery, or allow the battery to short-circuit. Do not expose battery being placed in high temperature environment, if battery leaks or bulges, stop continue to use.
- Always charge using the charger. Risk of explosion if battery is replaced by an incorrect type.
- Keep the battery out of reach of children.
- Batteries may explode if exposed to naked fire. Never dispose of batteries in a fire.
- Disposed of used batteries observing local regulations.
- Before disposing the device, please remove the battery.

## Conformity

The Manufacturer hereby declares that the CE marking was applied to the Rollei Compacline 800 in accordance with the basic requirements and other relevant provisions of the following CE Directives:

2011/65/EC RoHs Directive

2014/30/EU EMC Directive

2012/19/EC WEEE Directive



The EC Declaration of Conformity can be requested from the address specified on the Warranty card.