

Rollei

since 1920

USER GUIDE

FOR GERMAN | ENGLISH | SPANISH | ITALIAN | FRENCH | PORTUGUESE |
GREEK | DUTCH | POLISH | RUSSIAN | HUNGARIAN | TURKISH | NORWEGIAN |
DANISH | FINNISH | SWEDISH

24

Months Warranty
and Replacement

14.0

Megapixels

5 m

wasserdicht
waterproof

2.7"

LCD (6.85 cm)

1.5 m

stoßfest
shockproof

4x

Optical Zoom

720p

HD Video Function
1280 x 720 pixels



Smile & Face
Detection



Sportsline 99



Table of Contents

Preface	3
About this Manual	3
Safety and Handling Precautions.....	3
Using this Menu	4
Introduction	5
System Requirements	5
Main Features	5
Package Contents.....	6
Camera Views	7
Camera Buttons	8
Navigation Control.....	9
Camera Memory	10
Getting Started.....	10
Attach the Camera Strap.....	10
Inserting the Battery	10
Inserting an SD/SDHC/SDXC Memory Card.....	11
Charging the Battery by USB.....	12
Turning the Power On and Off	12
Initial Settings.....	12
Modes	12
Using the LCD monitor	13
LCD Monitor Layout.....	13
Changing the LCD Monitor Display	18
Recording Images, Videos and Voices.....	18
Taking Images	18
Setting the Zoom Control	19
Using Flash.....	20
Setting the Focus Mode	20
Using the Function Menu	21
Using the Record Menu.....	25
Using Voices Recording.....	36
Recording Videos.....	41
Playback	43
Viewing in Single Navigation.....	43
Viewing Thumbnails	43
Zooming images.....	44
Playing Videos.....	44
Playing Voice Recording	45
Playing Voice Memo.....	45
Deleting an Image/Video/Audio.....	46
Playback Menu	46
Using the Setup Menu.....	55
Setting Sounds.....	55
Setting Power Save.....	55
Setting LCD Save.....	56

Setting Date & Time	56
Setting Language	56
Setting File Numbering	56
Setting TV Out	57
Setting LCD Brightness	57
Setting Memory Kit	57
Reset All	57
Making Connections	58
Connecting the Camera to a TV	58
Connecting the Camera to a PC	58
Connecting the Camera to a Printer	59
Setting the Print Mode Menu	60
Appendix	61
About Folder and File Names	61
Troubleshooting	61
Specifications	62

Preface

About this Manual

This manual is designed to assist you in using your new digital camera. All information presented is as accurate as possible but is subject to change without notice.

Copyright

This manual contains proprietary information protected by copyright. All rights are reserved. No part of this manual may be reproduced by any mechanical, electronic or other means, in any form, without prior written permission of the manufacturer.

© Copyright 2011

Federal Communications Commission (FCC) Compliance

This equipment has been tested and found to comply with the limits for a Class B digital device, pursuant to Part 15 of the FCC Rules. These limits are designed to provide reasonable protection against harmful interference in a residential installation. This equipment generates, uses, and can radiate radio frequency energy and, if not installed and used in accordance with the instructions, may cause harmful interference to radio communications. However, there is no guarantee that interference will not occur in a particular installation. If this equipment does cause harmful interference to radio or television reception, which can be determined by turning the equipment off and on, the user is encouraged to try to correct the interference by one or more of the following measures:

- Reorient or relocate the receiving antenna.
- Increase the distance between the equipment and the receiver.
- Connect the equipment to an outlet on a circuit different from that to which the receiver is connected.
- Consult the dealer or an experienced radio/TV technician for help.

Warning: A shielded-type power cord is required in order to meet FCC emission limits and to prevent interference to radio and television reception. Use only shielded cable to connect I/O devices to this equipment. Any changes or modifications not expressly approved by the manufacturer may void your warranty and service agreement.

Declaration of Conformity

This device complies with Part 15 of the FCC rules. Operation is subject to the following conditions:

- This device may not cause harmful interference.
- This device must accept any interference received, including interference that may cause undesired operation.

Trademark Recognition

Windows 2000/XP/Vista/Win7 are registered trademarks of Microsoft Corporation in the United States and/or other countries. Windows is an abbreviated term referring to the Microsoft Windows Operation System. All other companies or product names are trademarks or registered trademarks of their respective companies.

Safety and Handling Precautions

Camera Information

- Do not take apart or attempt to service the camera yourself.
- Do not expose the camera to moisture, or extreme temperatures.
- Allow the camera to warm up when moving from cold to warm temperatures.
- Do not touch the camera lens.
- Do not expose the lens to direct sunlight for extended periods.
- Do not use abrasive chemicals, cleaning solvents or strong detergents to clean the product. Wipe the product with a slightly damp soft cloth.

Battery Information

- Turn off the camera before installing or removing the battery.
- When using Li-ion battery in this product, ensure that they are inserted correctly. Inserting the battery upside down can cause damage to the product and possibly cause an explosion.
- When the camera is used for an extended period of time, it is normal for the camera body to feel warm.
- Download all pictures and remove the battery from the camera if you are going to store the camera for a long period of time.
- The type of battery and the battery power level may cause the lens to be stuck up. Ensure you use the correct battery type and use a fully charged battery.
- Risk of explosion if battery is replaced by an incorrect type. Dispose of used batteries according to the instructions.

Notices



- It's from our indoor test only. We are not guaranteed that there will be no damage or malfunction in all similar conditions.
- Please note that all accessories are not waterproof.
- Must close the battery cover correctly. If water, dust or sand is inside the camera, it will cause malfunction.
- Do not open or close the battery cover at the locations like ocean or lake. Also, do not open or close it with wet hands.
- When you dive with the camera, please use the supplied strap, and make sure it puts on your wrist.

Cautions

- Do not use the camera at depth of 7.5 meters or more in water.
- Do not use the camera underwater over 2 hours.
- Do not open or close the battery cover in water.
- Do not use the camera in hot water, for example in hot spring.
- Do not put too much pressure on the camera; otherwise the camera will be damaged when you dive with it.
- Do not leave the camera at beach for preventing from sand being inside the speaker and microphone. Moreover, the camera will get heated gradually and exceed the operation temperature when it is exposed to sunlight.
- If your camera is stained with sunscreen lotion by accident, please clean it with warm water immediately; otherwise your camera body may become discolored.
- Once the camera has ever sustained strong shaking, dashing or high pressure, it may lose the capability of waterproof. Please contact your reseller or our maintenance department.

Using this Menu

Symbols used in this manual are explained below:

	This indicates useful information when using your camera.
	This indicates important message that should be read before using the function.

Introduction

Congratulations on your purchase of the new digital camera.
Capturing high-quality digital images is fast and easy with this state-of-the-art smart camera.

System Requirements

In order to get the most out of your camera, your computer must meet the following system requirements:

For Windows:

- Windows XP/Vista/Win7
- Processor: Pentium II 450MHz or above
- Memory: 512MB or above
- HDD space: 200MB or above
- 16bit color display monitor
- Microsoft DirectX 9.0C
- USB port and CD-ROM drive

For Macintosh:

- Power Mac G3 or later
- Mac OS 10.3.X (X=0-9) ~ 10.6.6 or later
- Memory: 512MB or above
- Q. Time player ver. 6.0.3 or above
- USB port and CD-ROM drive

Main Features

- 14 mega pixels resolution
- Up to 4x optical zoom and 5x digital zoom
- 2.7 inch color LCD monitor
- 32MB internal flash memory with optional external SD/SDHC/SDXC card
- Supports up to 4GB of SD card, and up to 32GB of SDHC card and to 64GB of SDXC card
- Easy-to-use button interface
- DCF, DPOF, PictBridge compatibility
- Slideshow to review still images
- A/V output to view your images, videos and audio on your TV
- USB port to transfer images, videos and audio to your PC

Package Contents

Please check the contents of your camera package. It should contain:

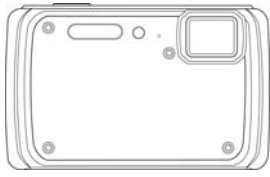

Digital camera



Rechargeable battery x 1 pcs



Wrist strap

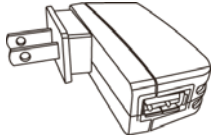

USB adapter



USB cable



CD-Rom

Camera Views

Front View

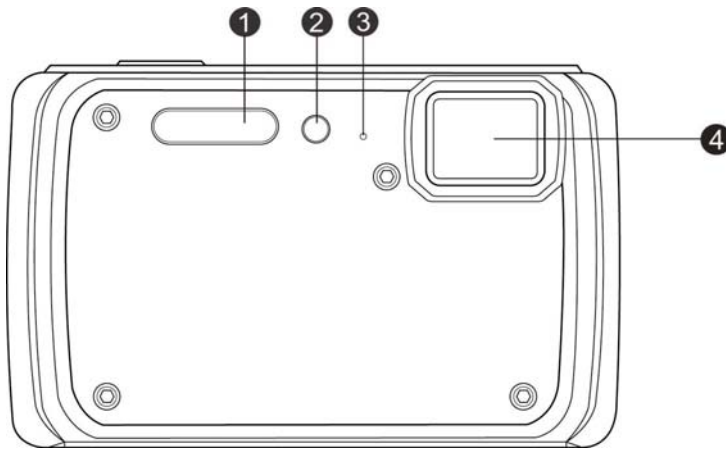

- 1. Flash
- 2. Self-timer LED/
AF Assist Lamp
- 3. Microphone
- 4. Lens

Back View

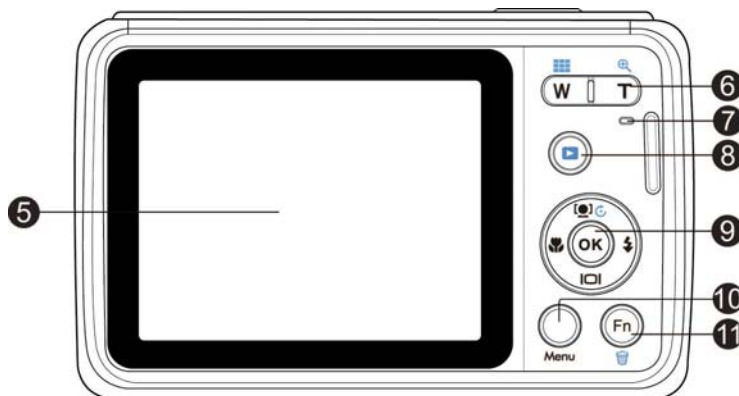

- 5. LCD monitor
- 6. Zoom button
- 7. LED indicator
- 8. Playback button
- 9. OK button/4-way
navigation control
- 10. Menu button
- 11. Function/Delete
button

Top View

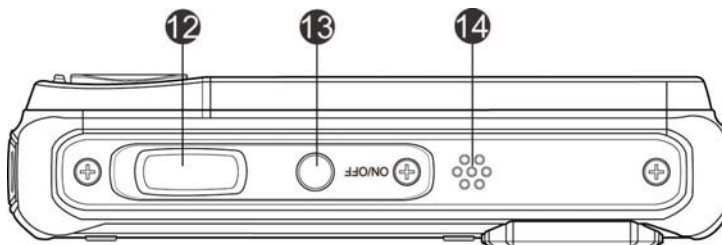

- 12. Shutter button
- 13. Power button
- 14. Speaker

Bottom View

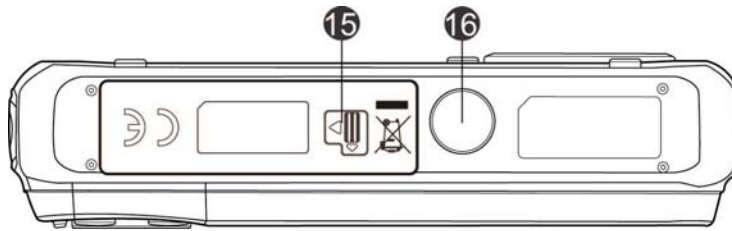

15. Battery/Memory card compartment

16. Tripod screw hole

Left/Right View

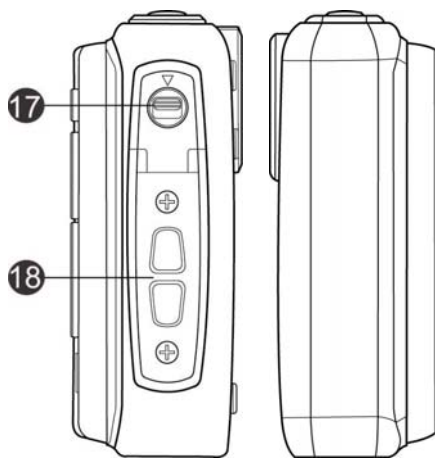

17. USB/TV Out

18. Strap ring

Camera Buttons

Your camera is equipped with different buttons for ease of use.

Button	Description
Power	Press the Power button to turn the power on/off.
Shutter	Press to capture an image or start/stop recording video or audio clip.
Zoom button	In photo and movie mode, press the zoom button to left to zoom out, right to zoom in. In Playback mode, press to zoom in to magnify image or zoom out enter 9-image/calendar thumbnails.
Menu	Press to enter or exit menu/submenu.
Function/Delete	In Photo and Movie mode, press to enter function menu. In Playback mode, press to delete an image, video or audio clip.

Navigation Control

The **4-way Navigation Control** and the **OK** button allow you to access the various menus available from the On Screen Display (OSD). You can configure a wide range of settings to ensure maximum results from your images and videos. Further functions of these buttons are as follows:

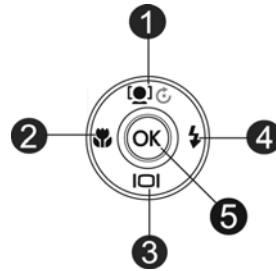

No.	Description
1	Face Tracking/Rotate Button
2	Macro Button
3	Display Button
4	Flash Button
5	OK Button

Button	Description
OK	<ol style="list-style-type: none"> 1. Confirm a selection when using the OSD menus. 2. In Playback Movie/Audio mode, press to Start video or audio playback.
Flash/Right	<ol style="list-style-type: none"> 1. In Photo Mode, press to scroll through the flash mode options. (Auto, Red-eye Reduction, Forced On, Slow Sync and Forced Off) 2. In Playback mode, press to view the next image, video or audio clip. 3. In playback Movie mode, press to Forward video playback. 4. In Menu, press to enter the submenu or to navigate through the menu selections.
Macro/Left	<ol style="list-style-type: none"> 1. In Photo Mode, press to scroll through Macro options. (Super Macro, Pan Focus, Infinity and normal) 2. In Playback mode, press to view the previous image, video or audio clip. 3. In Playback movie mode, press to Rewind video playback. 4. In Menu, press to exit a submenu or to navigate through the menu selections.
Up/Face Tracking/Rotate	<ol style="list-style-type: none"> 1. In Photo Mode, press to turn the face tracking function on and off. 2. Playing Video/Audio file, press to Pause/Start video or audio playback. 3. In Playback photo mode, press to rotate the image clockwise 90 degrees by each press of the button. This feature is applicable for still images only. 4. In Menu, press to navigate through the menu and submenu selections.
Display/Down	<ol style="list-style-type: none"> 1. The LCD monitor can be changed into 5 different types such as Basic, Full, None, Guideline and Help screen. 2. Playing Video/Audio file, press to stop video/audio playback. 3. In Menu, press to navigate through the menu and submenu selections.

Camera Memory

Internal memory

Your camera is equipped with 32MB of internal memory. Users can store files up to 13.5MB. If there is no memory card inserted in the memory card slot, all images, videos and audio clips recorded are automatically stored in the internal memory.

External storage

Your camera supports SD cards of up to 4GB in size. It also supports SDHC cards with a maximum capacity of 32GB. Then also supports SDXC cards with a maximum capacity of 64GB. If there is a storage card inserted in the memory slot, the camera automatically saves all images, videos and audio clips in the external storage card. The icon  indicates the camera is using SD card.



Not all cards may be compatible with your camera. When purchasing a card, please check the card's specifications and take the camera with you.

Getting Started

Attach the Camera Strap

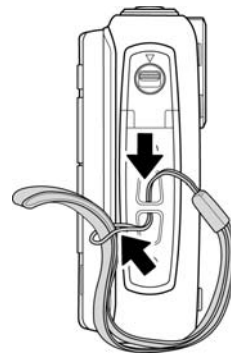

Inserting the Battery

Follow these instructions to insert the rechargeable battery into the battery/memory card compartment. Please read "Battery Information" on page 4 before inserting/removing batteries.

1. Make sure the power is off before inserting the battery.

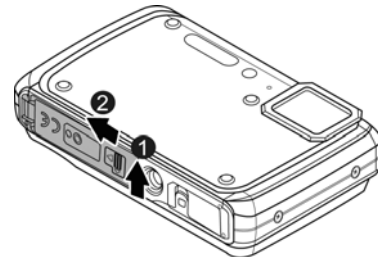

2. Unlock and open the battery/memory card compartment at the bottom of the camera by pushing up the cover latch and sliding to the left.

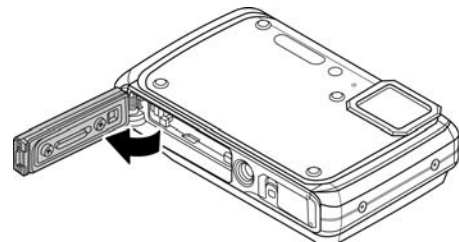

3. Insert the battery into the compartment with the terminal facing inside the camera with correct orientation as shown.

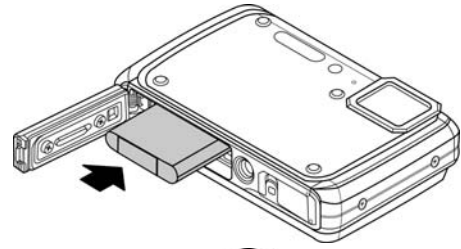

4. Close the battery/memory card compartment, and the cover latch is locked automatically.

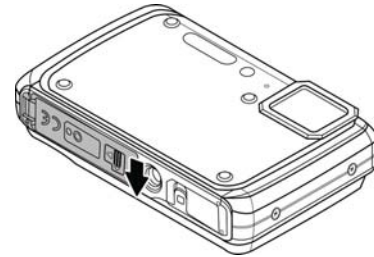
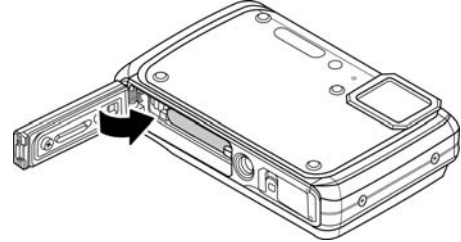

Inserting an SD/SDHC/SDXC Memory Card

Expand your camera's storage by using SD, SDHC or SDXC memory cards.

1. Unlock and open the battery/memory card compartment at the bottom of the camera by pushing up the cover latch and sliding to the left.
2. Insert the SD/SDHC/SDXC card into the memory card slot with the metallic part facing the back side of the camera.
3. Push the SD/SDHC/SDXC card into the memory slot until it clicks into place.
4. Close the battery/memory card compartment, and the cover latch is locked automatically.

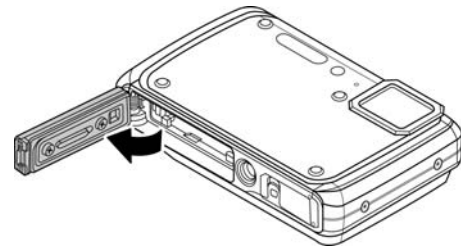

To remove the SD/SDHC/SDXC card

1. Unlock and open the battery/memory card compartment by pushing up the cover latch and sliding to the left.
2. Gently push the card until it pops out.
3. Pull out the card carefully.

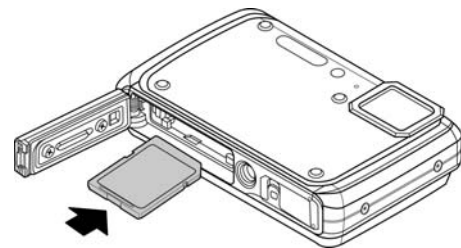

Windows 2000/XP are not support SDXC card (exFAT format). But in Windows XP (Service Pack 2 or 3), you can download exFAT patch update to support SDXC card.

Charging the Battery by USB

In other way charging the battery, you can use the USB cable to connect the camera with PC or USB adapter.

1. Connect the camera with the USB cable as shown.
2. Connect the other end with the USB adapter and plug it into a power outlet or with the USB port of PC directly for charging.
 - When the battery is charging, the LED indicator lights up.
 - When the battery is fully charged, the LED indicator goes off.
 - When the battery is unusual charged, the LED indicator flashes rapidly.
 - When the camera charges without the battery inside, the LED indicator goes off.

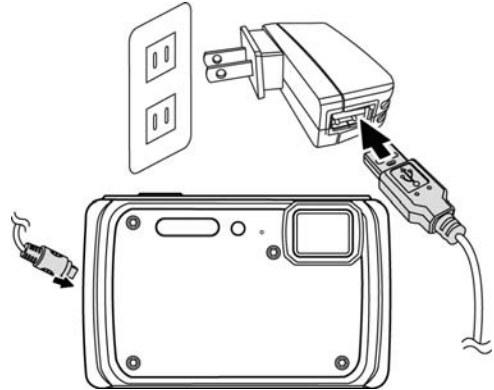

It's recommended not operating the camera when charging.

Turning the Power On and Off

There are two ways to turn on the camera:

- The startup image displays briefly and the startup sound plays if enabled. The zoom lens extends and the camera is turned on in Record mode.
- The camera is turned on in Playback mode. The zoom lens is not extended.

To turn off the camera, press the **Power button**.

See "Modes" on page 12 to know more about Record and Playback mode.

Initial Settings

When you turn on your camera for the first time, you will be asked to do the initial settings of your camera. First is the setup of language menu. Specify in which language menus and messages are to be displayed on the LCD monitor.

Setting the Language

1. Press ▲, ▼, ◀ or ▶ to move through the selection.
2. Select a language, and then press **OK** to apply.

Setting the Date & Time

1. Press ◀ or ▶ to move through the selection.
2. Press ▲ or ▼ keys to change the value for the date and time.
3. Press **OK** to apply.



4. If necessary, press **Menu** to close the menu.
- Now, you are ready to start taking images and videos.



Holding down ▲ or ▼ keys to change the values continuously.

Modes

Your camera has two modes:

Record Mode

This is the default mode while you turn on the camera every time. You are able to take images and record videos/audio clips in this mode.

Playback Mode

Press the **Playback** button  after the camera is turned on to view and edit captured images or playback videos and audio clips. The recording of voice memo attached to images is available in this mode.

Using the LCD monitor

The LCD monitor shows all important information regarding camera settings as well as the visual image of your image or video. The display on the LCD monitor is called the On Screen Display or OSD.

LCD Monitor Layout

Photo Mode Screen Layout

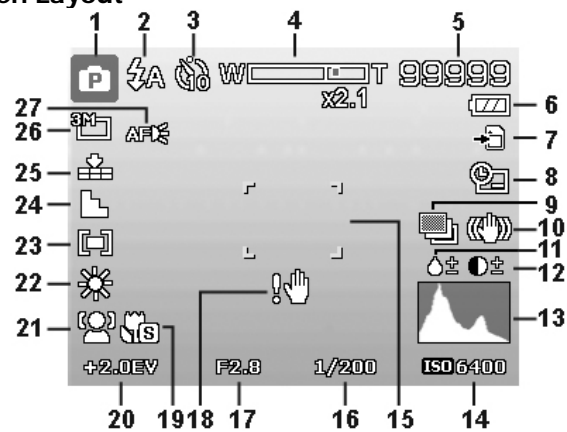

No.	Item	Description
1	Record Mode	Indicates the current mode.
2	Flash	Indicates flash settings.
3	Self-timer/Burst	Indicates drive mode settings.
4	Zoom indicator	Displays zoom.
5	Shots remaining	Indicates the remaining shots available.
6	Battery	Indicates battery level.
7	Storage media	Indicates current storage media in use.
8	Date stamp	Indicates date stamp is enabled.
9	AEB	Indicates AEB function is enabled
10	Stabilizer	Indicates stabilizer function is enabled.
11	Saturation	Displays saturation settings.
12	Contrast	Displays contrast settings.
13	Histogram	Graphic display of Brightness.
14	ISO	Displays ISO settings.
15	Focus area	Indicates focus area.
16	Shutter speed	Displays shutter speed settings.
17	Aperture value	Displays aperture settings.
18	Shake warning	Indicates that the camera is shaking.
19	Focus	Indicates focus is enabled.
20	Exposure	Displays exposure settings.
21	Face tracking	Indicates face tracking is enabled.
22	White balance	Displays white balance settings.
23	Metering	Displays metering settings.
24	Sharpness	Displays sharpness settings.
25	Quality	Displays quality settings.
26	Photo size	Displays photo size settings.
27	AF lamp	Indicates AF lamp is enabled.

Scene Mode - Movie Mode Screen Layout

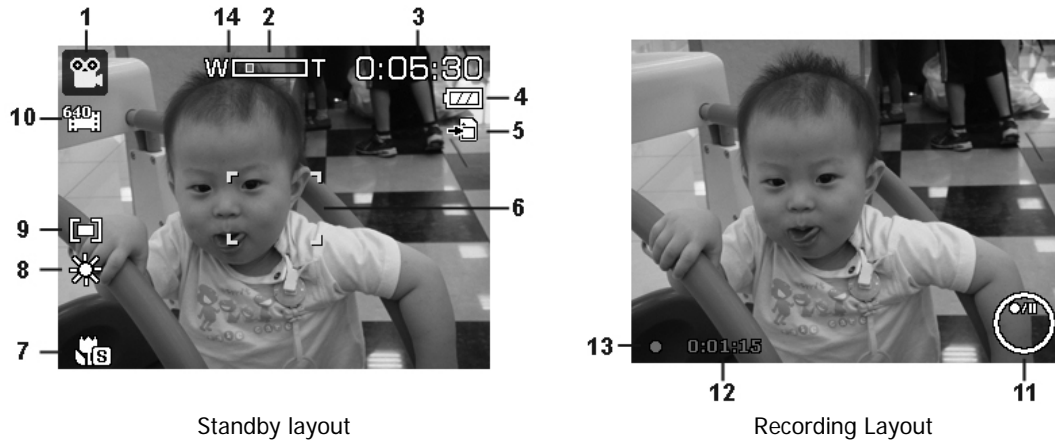

No.	Item	Description
1	Record Mode	Indicates the current mode.
2	Zoom indicator	Displays zoom.
3	Time remaining	Indicates the remaining time of video available.
4	Battery	Indicates battery level.
5	Storage media	Indicates current storage media in use.
6	Focus area	Indicates focus area.
7	Focus	Indicates focus is enabled.
8	White balance	Displays white balance settings.
9	Metering	Displays metering settings.
10	Movie size	Displays movie size settings.
11	Key indicator	Displays the commands on 4-way Navigation Control button
12	Recorded time	Displays recorded time.
13	Recording status	Indicates recording status.
14	Pre-record 	Indicates pre-record is enable



The Pre-Record icon appears on the screen in red color as the same position as zoom indicator.

Playback Mode Screen Layout

The Playback mode display varies depending on the type of image being viewed.

Playback mode display of still images:

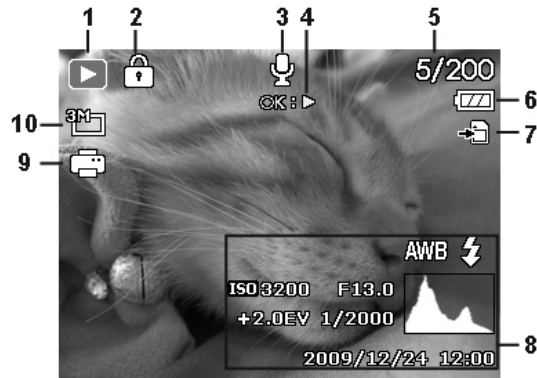

No.	Item	Description
1	Playback mode	Indicates playback mode.
2	Protect	Indicates file is protected.
3	Voice memo	Indicates voice memo is attached.
4	Button intro	Indicates the button to press on the camera to play a video or audio file.
5	File no./Total no.	Indicates the file number over the total number of files in the storage card.
6	Battery	Indicates battery level.
7	Storage media	Indicates used storage memory.
8	Recording information	Displays recording information of the file.
9	DPOF	Indicates the file is marked for printing.
10	Image Size	Displays the image size settings.

Playback mode of videos:

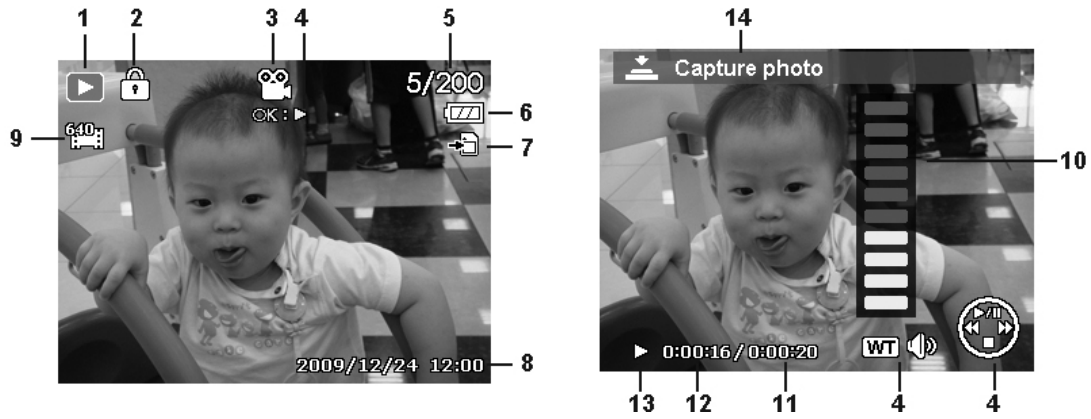

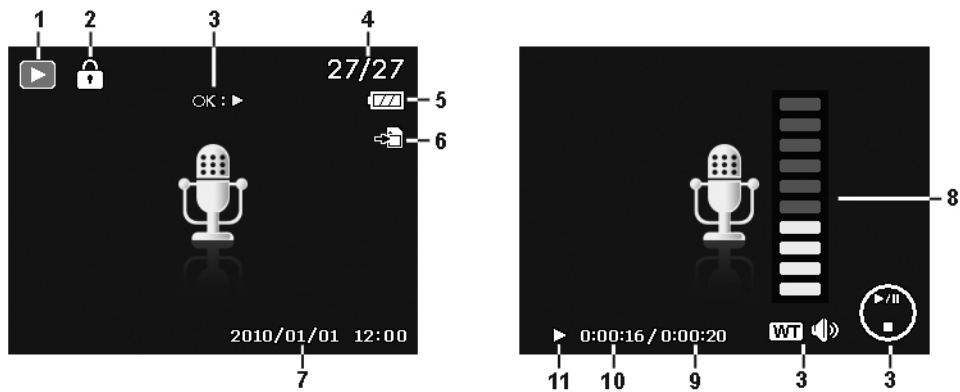

No.	Item	Description
1	Playback mode	Indicates playback mode.
2	Protect	Indicates file is protected.
3	Video clip	Indicates the file is a video.
4	Button intro	Indicates the button to press on the camera to play a video or audio file.
5	File no./Total no.	Indicates the file number over the total number of files in the storage card.
6	Battery	Indicates battery level.
7	Storage media	Indicates used storage memory.
8	Recording date & time	Displays the date and time of the video clip.
9	Video size	Indicates the size of the video clip.
10	Volume	Indicates the volume while playing.
11	Video length	Display the total length of the video clip.
12	Played time	Indicates the played time of the video.
13	Playing status	Displays playing status.
14	Capture image	Capture the screenshot and save.

Playback mode of audio clips:



No.	Item	Description
1	Playback mode	Indicates playback mode.
2	Protect	Indicates file is protected.
3	Button intro	Indicates the button to press on the camera to play a video or audio file.
4	File no./Total no.	Indicates the file number over the total number of files in the storage card.
5	Battery	Indicates battery level.
6	Storage media	Indicates used storage memory.
7	Recording information	Displays recording information of the file.
8	Volume	Indicates volume settings.
9	Audio length	Display the total length of the audio clip.
10	Played time	Indicates played time.
11	Playing status	Displays playing status.

Changing the LCD Monitor Display

The type of information displayed on the LCD monitor can be changed using the  button. Press the  button repeatedly to change the LCD display from one type to another. In Photo/Movie Mode, the LCD display can be changed into any of the following:

- Basic
- Full
- None
- Guideline
- Help screen



- The OSD information may vary depending on the record mode type.
- The following icons, if enabled, are still displayed on the LCD even when OSD off or Guide lines on: AEB, Face tracking, AF lamp, Drive mode, and Focus.
- Use the "Guide lines" to properly set image for capture.

In Playback mode, the LCD display can be changed into any of the following:

- Basic
- Full
- None
- Help screen



LCD display cannot be changed in the following situations:

- Adjusting Aperture value/Shutter speed under Manual exposure mode.
- Adjusting Aperture value under Aperture Priority mode.
- Adjusting Shutter speed under Shutter Priority mode.
- Recording video or audio clips
- Playing video or audio clips
- Playing slideshow

Recording Images, Videos and Voices

Taking Images

Now that you are familiar with your camera, you are now ready to take your images. Taking images with your camera is very simple.

1. Turn on the camera by pressing the **Power button**.
2. Frame the shot using the focus bracket on the LCD monitor. See illustration on the right.
3. Pressing the **Shutter button** down halfway automatically focuses and adjusts the exposure, and pressing the **Shutter button** down fully captures the images.



When the shake warning icon  appears, hold the camera steadily, with your arms at your side or use a tripod to stabilize the camera to prevent blurred images.



Setting the Zoom Control

Using a combination of 4 times optical zoom and 5 times digital zoom permits zoom photography at up to 20 times magnification. While the digital zoom can be a useful feature, the more an image is enlarged (zoomed), the more pixelated (grainier) the image will appear. Please refer to "Setting the Digital Zoom" on page 39 on how to setup digital zoom.

To adjust the optical zoom:

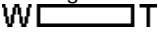
1. Press the **Zoom button** to zoom in or zoom out an image.
2. The zoom indicator appears on the LCD monitor. 

Zoom button

1. Press the button right (T) to zoom in.
2. Press the button left (W) to zoom out.



To adjust the digital zoom:

1. Activate digital zoom. See "Setting the Digital Zoom" on page 39.
2. Press the **Zoom button** clockwise/counterclockwise optically zooms in/out to the maximum until it stops.
3. Release the **Zoom button**.

Optical zoom 1X to 4X Digital zoom 1X to 5X



Digital zoom is not activated in recording videos

Using Flash

When taking pictures in difficult lighting conditions, use the **Flash/Right** button to get correct exposure. This function cannot be activated in recording videos or continuous shooting.

To activate Flash:

- Press the **Flash/Right** button on your camera repeatedly until your desired flash mode is displayed on the LCD monitor.

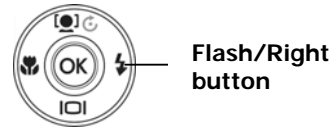

Your camera is equipped with five flash modes:

⚡A AUTO. The flash fires automatically whenever extra lighting is needed.

⚡👁 Red-eye reduction. The flash fires twice to reduce the red-eye effect.

⚡ Forced on. The flash fires whenever you press the Shutter button regardless of lighting conditions.

⚡SL Slow sync. The flash fires with a slow shutter speed.

🚫 Forced off. The flash is turned off.



- Flash function is only available in shooting still images but not available in Burst and AEB modes.
- Do not charge the flash while pressing the Zoom button. Charge the flash after releasing the zoom button if necessary.

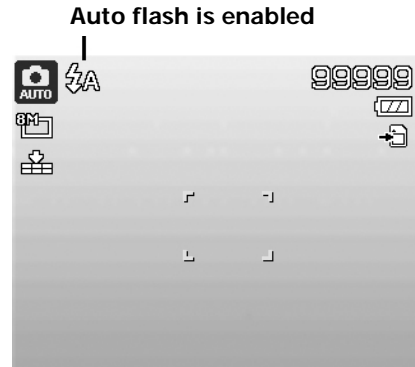

Setting the Focus Mode

This function allows users to define the type focus when recording a still image or a video clip.

To set the Focus mode

- Press the **Macro/Left** button repeatedly until the desired focus mode icon is displayed on the lower left corner of the LCD monitor.



Your camera supports the four focus modes:

Normal. With normal focus, the focus range starts from 0.1 m. When the camera is set to Normal mode, there is no icon displayed on the screen.

👁S Super Macro. This mode is designed for close-up photography. When Super Macro is set, the focus cannot be adjusted until Super Macro is canceled.

PF Pan Focus. The focus of this mode is in the maximum Depth of Field (DOF), not designing for close-up photography.

INF Infinity. When Infinity is set, the camera focuses on distant objects.

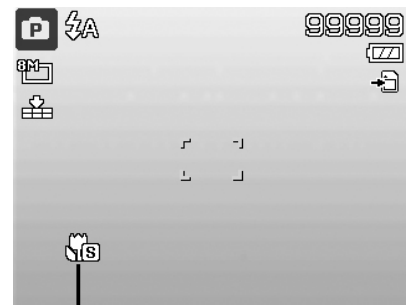

Using the Function Menu

The **Function Menu** is used to adjust capture settings in Photo Mode. It contains My Mode, Photo Size, Quality, EV Compensation, White Balance, ISO, Metering, and Color Mode.



Press the **FN** button of your camera to launch the Function Menu.
Press the **FN** button again to close the menu.

- The Menu bar displays the current status of your camera settings. Only the available functions for the settings are shown as icon on the menu bar.
- The available options for each item on the menu bar are shown in the Menu options.
- Use the ◀ or ▶ key to move through the menu selections then press the **OK** button to save and apply changes.

Menu bar

Menu Options

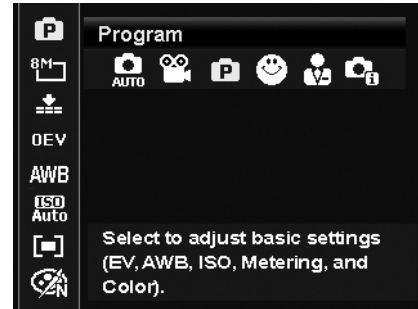

My Mode

1. The My Mode function displays the **4** most recent modes used in order. When you move through the different modes in the menu options, the items on the menu bar changes synchronously to the corresponding available settings.
2. **Auto** and **Movie** mode are fixed in the first two of Menu options.

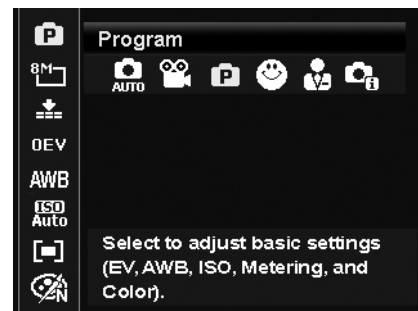
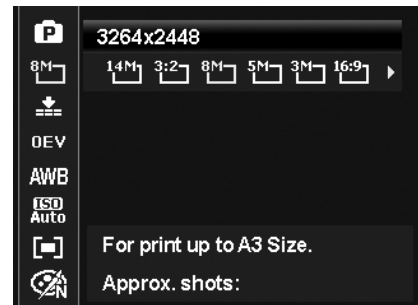

Photo Size

The Photo Size function is used to set the resolution before you capture the image. Changing the Photo Size affects the number of images that can be stored in your memory card. The higher the resolution, the more memory space is required.



The table below shows the Photo Size values for still images.

Icon	Pixel Size	Printing Size Suggestion
	4320 x 3240	A2 Size
	4320 x 2880	Standard print paper
	3264 x 2448	A3 Size
	2592 x 1944	A4 Size

Icon	Pixel Size	Printing Size Suggestion
	2048 x 1536	4" x 6"
	1920 x 1080	HDTV
	640 x 480	E-mail

Quality

The Quality sets the quality (compression) at which the image is captured. The quality determines the amount of compression applied to your images. Fine quality would give you the best images with sharper details and less compression. However, the higher the quality, the more memory space is required in your memory card.

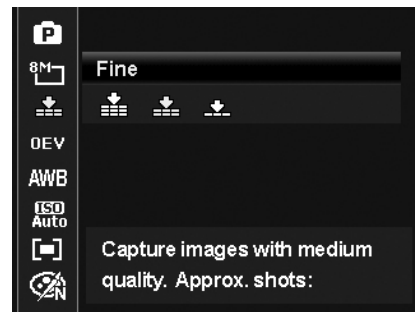

EV Compensation

Images can be captured with the overall scene intentionally made brighter or darker. These settings are used when a suitable brightness (exposure) cannot otherwise be obtained in circumstances where the difference in brightness between the subject and the background (the contrast) is large, or when the subject that you wish to capture is very small within the scene. Available for still images only.

- To adjust EV settings, press the ◀ or ▶ keys to increase/decrease the value. As you adjust the settings, the LCD monitor synchronously displays the image applying the EV settings. Press the **OK** button to save and apply changes.



White Balance

This sets the white balance for a variety of lighting conditions and permits images to be captured that approach the conditions that are seen by the human eye.

- As you move through the selection, you can see the preview on the LCD monitor synchronously.



Icon	Item	Description
	Auto White Balance	The camera automatically adjusts the white balance.
	Daylight	Ideally used for bright sunny conditions.
	Cloudy	Ideally used for cloudy conditions.
	Tungsten	Ideally used for indoor images with tungsten or halogen lighting without a flash.
	Fluorescent 1	Ideally used for indoor images with bluish fluorescent lighting conditions.
	Fluorescent 2	Ideally used for indoor images with reddish fluorescent lighting conditions.
	Custom	Used when light source cannot be specified. Press the Shutter button for the camera to automatically adjust the appropriate white balance setting according to the environment.

ISO

This sets the sensitivity for capturing images. When the sensitivity is raised (and the ISO figure is increased), photography will become possible even in dark locations, but the more pixelated (grainier) the image will appear.

- Use a higher ISO setting in dim conditions and a lower ISO setting in brighter conditions.

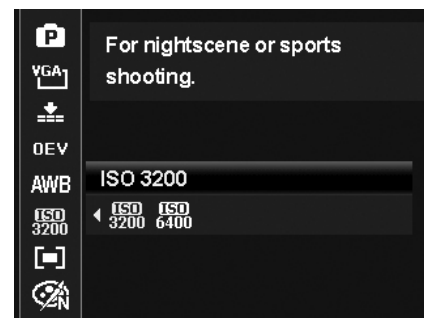

If the Stabilizer is enabled, ISO is automatically set to Auto and cannot be adjusted. To adjust ISO disable Stabilizer first.

Metering

This sets the metering method for calculating the exposure.

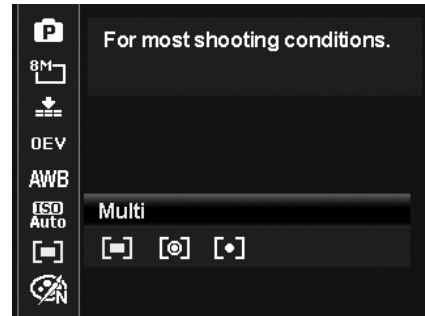

Icon	Item	Description
	Multi	The entire area of the screen is measured, and the exposure is calculated.
	Center	Averages the light metered from the entire frame, but gives greater weight to the subject matter at the center.
	Spot	A very small portion of the center of the screen is measured, and the exposure is calculated.

Color Mode

The Color Mode function applies different colors or tones for a more artistic effect on the still images or videos.

- As you move through the selection, the preview on the LCD monitor changes synchronously.



Icon	Item	Description
	Normal	The camera records normally.
	Vivid	The camera captures the image with more contrast and saturation emphasizing on the bold colors.
	Sepia	Images are captured in sepia tones.
	Color Accent (Red)	Retains red tone while the rest of the scene becomes black and white.
	Color Accent (Green)	Retains green tone while the rest of the scene becomes black and white.
	Color Accent (Blue)	Retains blue tone while the rest of the scene becomes black and white.
	B&W	Images are captured in black and white.
	Vivid Red	Captured image becomes reddish. Ideally used to record images like flowers and cars to make them more vivid.
	Vivid Green	Captured image becomes greenish. Ideally used to record images like mountains and lawns to make them more vivid.
	Vivid Blue	Captured image becomes bluish. Ideally used to record images like the sky and the ocean to make them look more vivid.

Using the Record Menu

If you are in Photo Mode, you can access the Record menu simply by pressing the **MENU button** on your camera.

When the menu is displayed, use the 4-way navigation control and the **OK button** to move through menu selections and apply your desired settings. To close the menu anytime, press the menu button again.

Record Menu

The Record menu allows you to change modes, and setup other capture settings.

To go to Record Menu:

Turn on the camera by pressing **Power button**.



1. Press **Menu** to launch the Record Menu.
2. Use the **▲** or **▼** keys to move through the menu
3. To select an item, press **▶** or **OK** button.
4. Change the submenu settings using the 4-way navigation control.
5. Press the **OK** button to save and apply settings.

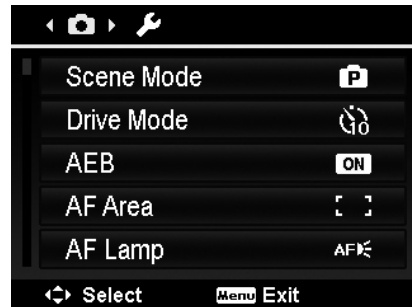

Setting the Scene Mode







By simply selecting one of the following 37 modes, you can capture the image or record the audio with the most appropriate settings.











1. From the Record Menu, press to select **Scene Mode**.
2. Use the navigation controls to move through the selection.
3. Press the **OK** button to save and activate the selected scene mode.



The table below shows the available scene mode settings.

Icon	Item	Description
	Auto	The simplest way to shoot basic images. Settings are adjusted automatically.
	Movie	This mode is used to record movie clips.
	Program	The camera automatically adjusts suitable shooting settings like shutter speed and aperture values.
	Intelligent Scene	The camera detects the shooting conditions and automatically switches to the appropriate scene mode.
	Portrait	Focus on portraits and soften the background to give the image a sense of depth. Enhance natural skin tones.
	Landscape	This feature is used to emphasize wide scenic views.
	Sunset	This feature enhances the red hue for recording sunset images.

	Backlight	This feature is used to capture the image of a backlight object by changing the metering.
	Kids	This feature is used to capture still images of moving kids.
	Night Scene	This feature is used to capture images with night scenery background.
	LOMO	This feature is used to capture images with over-saturated colors, off-kilter exposure or blurring.
	Fireworks	For shooting firework displays in vivid colors. It's recommended to use a tripod.
	Snow	This feature is used for beach and snow scenes.
	Sports	This feature captures still images in high speed motions.
	Party	This feature is used for wedding or indoor party settings.
	Candlelight	This feature is used to capture warm candle light effects.
	Night Portrait	This feature is used to capture portrait pictures with night or dark background.
	Soft Skin	This feature enhances skin tone thus facial skin appears smooth.
	Flowing Water	This feature enhances smooth effects like water or silk.
	Food	This feature is used to capture food images. The increased saturation in this mode makes the captured image more enticing.
	Building	This feature enhances the edges of captured images.
	Underwater	For underwater shooting.
	Text	This feature enhances the black and white contrast normally used when capturing text images.
	Foliage	This feature boosts the saturation of greens to give a rich color to foliage.
	Auction	This feature combines up to 4 shots into a single image and provides 4 patterns to select for usage of auction.
	Smile Capture	This feature uses face tracking to auto detect faces to capture. When smiles are detected, it continuously captures the image.

	Blink Detection	This feature detects if the subject blinked an eye when the image is captured and gives the user an option whether to save it or not.
	Pre-composition	This feature captures an image temporarily as a reference. Full press shutter after referring the subject to the reference point.
	Love Portrait	This feature uses face tracking to auto detect faces to capture portraits images without the help of others. When over two faces are detected, AF is automatically activated. The camera starts count down and captures a picture in two seconds.
	Self Portrait	This feature set zoom to wide end. When one face is detected, AF automatically activated and plays the sound (Bi) for notice. Then camera starts count down and captures a picture in two seconds.
	D-Lighting	This feature enhances the shadow and highlight details of an image.
	Fisheye Lens	This feature capture images with fisheye lens effects.
	Photo Stitch	This feature combines a panoramic photo from multiple shots.
	Aperture Priority	This feature lets users to adjust the aperture value and the camera automatically selects the shutter speed to match the brightness.
	Shutter Priority	This feature lets users to adjust the shutter speed and the camera automatically selects the aperture value to match the brightness.
	Manual Exposure	This feature lets users to adjust the shutter speed and aperture value to correctly expose your images.
	Voice Recording	This mode is used to record audio clips.

After selecting the scene mode, the selected mode, except Voice Recording, will be added to the forefront in **My Mode** of Function Menu. In the Menu Options, the **Auto** and **Movie** mode are fixed and the other 4 items can display the most recent used modes. See "Using the Function Menu" on page 21.

Using Intelligent Scene

This feature is most useful for novice users to capture great images even without basic knowledge of photography. Simply frame the shot with the help of Intelligent Scene Mode, the camera automatically recognizes 11 kinds of scenes - Portrait, Landscape, Sunset, Macro, Text, Snow, Backlight, Backlight Portrait, Night Scene, Night Portrait and Foliage - and selects the ideal settings.

Intelligent scene icon. After the camera detects the shooting conditions, this icon changes to show the detected scene mode.

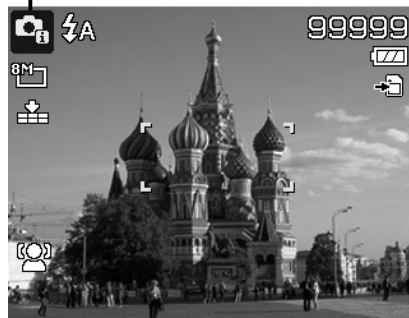

The camera changed to Landscape mode automatically.

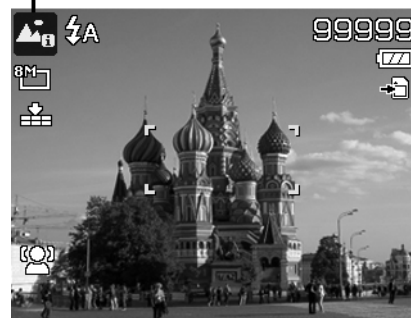

To activate Intelligent Scene

1. Select from the Scene Mode submenu.
2. Focus the camera on the subject to capture.
3. The camera detects the shooting conditions and switches to an appropriate scene mode.
4. Half press the Shutter button to focus the subject. The frame turns green to indicate focus is set.
5. Press the Shutter button to take the shot.

Using Kids Mode

Tactically, kids are the most difficult to photograph. They tend to be highly animated and can be a real challenge to make them pay attention for more than just a second or two. To capture a great moment for your kids, just keep the camera in kid mode. The mode provides higher shutter speed and always focuses on moving subject.



Using Sports Mode

When you need a series of sports motion images, such as a golf swing, or try to capture the images of a flying hummingbird/butterfly, be sure to switch the scene mode to sports mode. This mode provides shutter in **Burst speed** (Keep shooting images long as the Shutter button is pressed) which allows you to capture a sequence of pictures that are frames apart clearly.



Make sure you have plenty of memory in your memory card as you will need it when you start shooting.

Using Party Mode

Let the Party mode on! It can be difficult to get everyone on a party. While you have the whole gang together, take a group or family portrait. Party mode features on Red-eye reduction flash and face tracking. You'll miss fewer shots, and have more time to focus on enjoying the party.

Using Soft Skin mode

When the soft skin mode is activated, it makes wrinkles and lines look less conspicuous, while preserving resolution in areas of the picture outside of the skin. The camera detects skin color area, such as the face and processes the image to make the skin appear smooth.

Using Food Mode

How to share your dining experiences and comments of interesting widgets on your blog by close-up images? Just get the camera and set the scene with food mode. This mode features on macro focus and auto flash designed for close-up photography.



Macro focus and Auto Flash are enabled by using Food mode.

Using Foliage Mode

A scenic image, such as a garden or forest scene, that full of dull green colors is boring. In foliage mode, the greens, blues, are brilliantly enhanced making scenic pictures pop out with bright color.

Using LOMO Mode

The LOMO mode applies the following effects on the photo:

1. Over-saturated colors
2. Off-kilter exposure
3. Blurring
4. Darkening around the edges of photo



Original



LOMO

Using Auction Mode

It's hard and wastes a lot of time to combine several images by software. Select Auction mode and choose a pattern, then take a few shots from different angle. The camera composes a combined image in lower resolution suited to online posting.

1. Select Auction mode from Scene mode menu.
2. Use ◀ or ▶ keys to choose a pattern.
3. Press the **OK** button to start shooting.

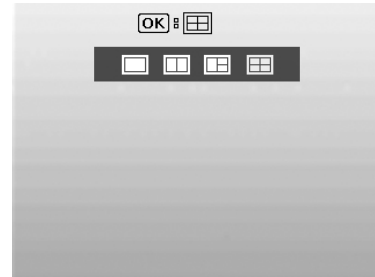

4. Frame the subject and press the **Shutter** button to take the first shot.

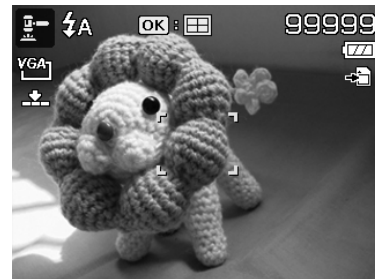

5. Press **OK** button to continue the second shot.
6. Or, press **Menu** button to go back the first shot.

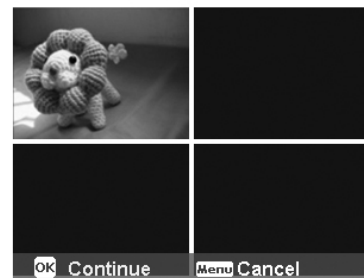

7. Repeat step 4 to 6, until the pattern is filled in images.
8. Press **OK** button to save the composed image.
9. Or, press **Menu** button to go back last shot.



10. The camera save the image to memory.
11. Use USB cable or memory card reader (Please refer to "Connecting the Camera to a PC" on page 58) to transfer the image to PC and upload it to website.

Auction mode provides 4 kinds of pattern as follow

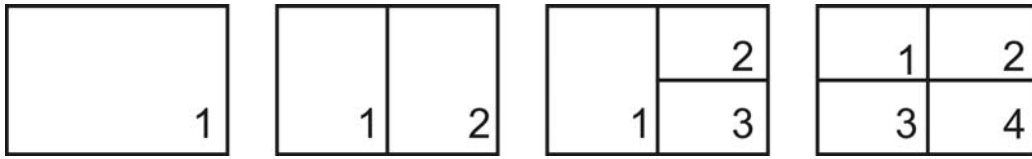

The image is set to low quality and VGA (640x480) size only.

Using Smile Capture Mode

When facing camera, especially kids, smiles are always short and hard to seize by manual shutter. Smile capture mode detects every smile all the time and performs Automatic Focus (AF) to capture an image without pressing Shutter button.

Follow the instructions to get a **Happy** image by Smile Capture Mode:

1. Select Smile capture mode from scene menu.
2. Focus the camera on the subject to capture.
3. When a smile is detected, the white focus frame turns green to denote camera shutter and take a shot automatically.



Using Blink Detection Mode

Nothing ruins a great picture more than having your subjects' eyes closed. Blink Detection provides you with extra assurance when capturing once-in-a-lifetime moments like holding a trophy with teammates after winning a basketball game.

If closed eyes are detected, a saving confirmation menu appears on the screen, allowing you to re-take the shot before your subject or subjects move on.

To activate Blink Detection

1. Select Blink Detection Mode from Scene Mode submenu.
2. Half press the **Shutter button** to focus the subject. The frame turns green to indicate focus is set.
3. Press the **Shutter button** to capture the image and automatically save the Image.
4. If the camera detects subject blinked eye, a "**Save image**" or "**Cancel**" option appears on the screen.
5. Select **Save image** to save or **Cancel** to disregard

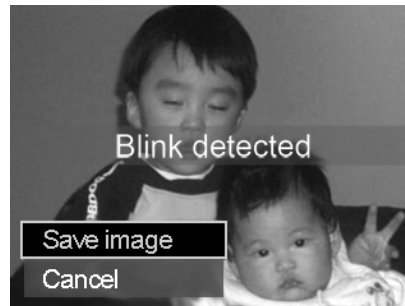

Using Pre-composition Mode

When asking someone else to take images for you, but the images always don't come up right?

Pre-composition helps you get the background you want, even if you need to ask someone else to record the image for you.

Basically, Pre-composition is a two-step process.

1. Compose the background you want and press the **Shutter button** (full press), which causes 1/3 of semi-transparent image of the background to remain on the LCD monitor. Press **Menu button** to cancel the semi-transparent temporarily image.
2. Ask someone else to record a shot of you against your original pre-composed background, telling him/her to compose the image by using the 1/3 semi-transparent screen image as a guide.
3. Move your position until photographer confirm your whole or half body in the frame and in the right place.
4. Press the Shutter button. Camera stores the image produced by this step only.



Using Love Portrait

Want to take a good image when there are just two of you? All you have to do is hold the camera and show your smiles together.

If over two faces had been recognized, the camera performs 2-second countdown with a beep notice then take a shot without pressing the **Shutter button**.

Using Self Portrait

When you are the one taking the picture for yourself, then self portrait mode is necessary besides the tripod. With your long arm's help, the camera begin face tracking in self portrait mode. If a face had been recognized, the camera performs 2-second countdown with a beep notice then take a shot without pressing the **Shutter button**.

Tips to make a great shape by self portrait photography:

- Lean in towards the camera to reduce double chin.
- Angle your body and bend your arms to look slimmer.
- Keep your shoulders back.

Using D-Lighting Mode

Active D-Lighting mode preserves details in highlights and shadows, creating photos with natural contrast. Use for high contrast scenes, for example, when photographing brightly light outdoor scenery through a door/window, or taking pictures of shaded subjects on a sunny day. With this feature, the adjustment of contrast is accomplished in-camera and requires no additional post-processing for the bulk of images.

Using Fisheye Lens Mode

For shooting fisheye photos with more creative and fun.



Original



Fisheye Lens

Using Photo Stitch Mode

Use this feature to create a panoramic photo from multiple shots. You can combine up to 2 or 3 shots into one single image quickly and easily.

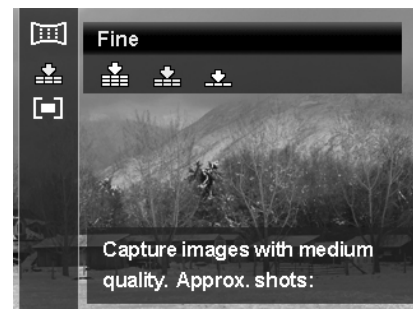

To stitch the still image

1. Enter Photo Stitch mode and press the UP key to select the direction how shots will be stitched. Then, press the Shutter button to take the first shot.
2. A guidance bar appears after taking the first shot. Follow the direction displayed on LCD screen to pan the camera. Or, press the Menu button to restart shooting.



3. Once the  icon overlaps the yellow block, you can get another shot without pressing the shutter button.

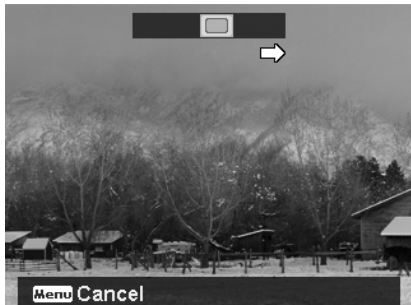

4. After taking the second shot, the yellow block moves to the end of the guidance bar, and the OK button appears as well. You can press the OK button to stitch the first two shots, or the Menu button to restart shooting.

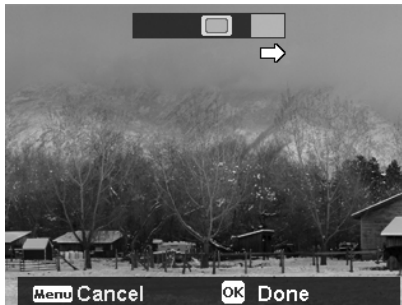

5. Same as step 3, moves the  icon to overlap the yellow block, and then you can get the third shot and the combined image is generated automatically. Now, you finish this set of stitch shooting.



The following settings are fixed in Photo Stitch mode:

- Flash: Forced Off
- Drive mode: Off
- Focus mode Auto focus
- AF Area: Wide

Using Aperture Priority Mode

This mode is designed for control the aperture value by user and let camera decide the shutter speed. The main impact that aperture had on images was with regards to Depth of Field. (DOF)

- Choose larger aperture, only one subject in focus but the background nice and blurred. (Shallow DOF)
- Choose smaller aperture, an image with everything in focus. (Great DOF)

To set Aperture values

1. Select Aperture Priority Mode from the Scene Mode submenu.
2. Press OK button to enter the adjust mode.
3. Use the ▲ or ▼ keys to select the aperture value options.
4. Press the Shutter button to capture the image.



Displays the aperture value

Using Shutter Priority Mode

This mode is designed for capturing moving subjects. A faster shutter speed is required to freeze a motion (flying birds), while the slower shutter speed creates a sense of motion (water flowing).

To set Shutter values

1. Select Shutter Priority Mode from the Scene Mode submenu.
2. Press OK button to enter the adjust mode.
3. Use the ◀ or ▶ keys to select the shutter value options.
4. Press the Shutter button to capture the image.



Displays the shutter value

Using Manual Exposure

When the camera is in the manual exposure mode, you can change either aperture or shutter speed, or both.

To activate Manual Exposure

1. Select from the Scene Mode submenu.
2. Press OK button to enter the adjust mode.
3. Use the ◀ or ▶ keys to select the shutter speed.
4. Or, use the ▲ or ▼ keys to select the aperture value.
5. Use the OK button to switch between aperture and shutter speed adjustment and vice versa.
6. Press the Shutter button to capture the image.



Displays the aperture and shutter speed value

Using Voices Recording

1. From the Scene menu, select **Voice REC**. The Voice Recording screen layout is displayed on the LCD monitor.
2. Press the **Shutter button** to start recording.
3. Press the **Shutter button** again to stop recording.

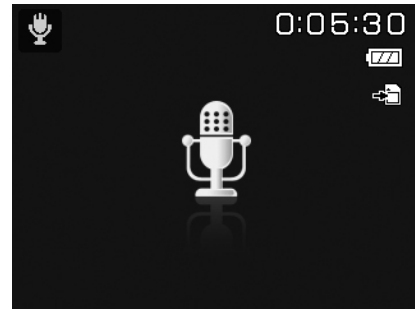

Setting the Drive Mode

Your camera features a Self-timer and Burst which can be set in the Drive mode function in the Record Menu. The Self-timer allows you to take images after a pre-defined delay. While burst lets you take consecutive shots. This function is only available in recording still images. The Drive mode setting is automatically set to off when you turn off the camera.

To set the Drive Mode

1. From the Record menu, select **Drive Mode**.
2. Use the **▲** or **▼** keys to go through the selection.
3. Press the **OK** button to save and apply changes.

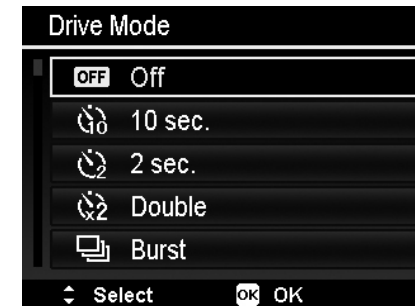
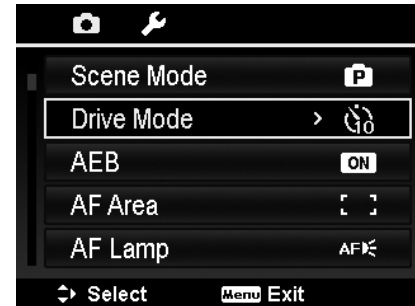

The table below shows the available Drive mode settings.

Icon	Item	Description
	Off	Captures an image without time delay.
	10 Sec.	Sets a 10-second delay to capture image after pressing the Shutter button.
	2 Sec.	Sets a 2-second delay to capture image after pressing the Shutter button.
	Double	Performs delay and capture twice: <ul style="list-style-type: none"> • Performs a 10-second delay, then captures the image. • Performs another 2-second delay then captures the image again.
	Burst	Performs continuous shooting when the Shutter button is pressed. Stops shooting when the shutter button is released.
	Speedy Burst	Captures 30 images in a shot when the Shutter button is pressed. Auto set Image size to VGA only.

Setting the AEB

AEB stands for Automatic Exposure Bracketing. It permits 3 consecutive images in the order of standard exposure, under exposure and overexposure compensation.

To set AEB

1. From the Record menu, select **AEB**.
2. Use the ▼ or ▲ keys to go through the selection.
3. Press the **OK** button to save and apply changes.

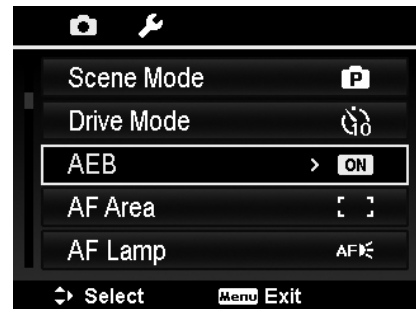

Setting the AF Area

AF stands for Automatic Focus. This feature determines the area on which the camera focuses.

To set AF Area

1. From the Record menu, select **AF Area**.
2. Use the ▲ or ▼ keys to go through the selection.
3. Press the **OK** button to save and apply changes.

The table below shows the available AF area settings.

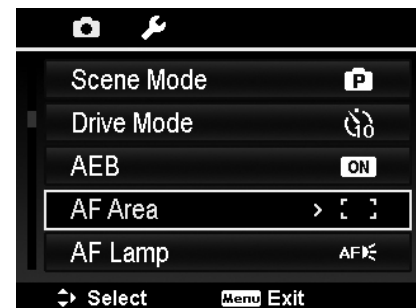

Icon	Item	Description
	Wide	The camera automatically selects focus area within the wide frame.
	Center	The focus area is fixed on the center.

Setting the AF Lamp

The AF Lamp function allows you to record images even low light conditions.

If AF Lamp is set to Auto, the AF lamp located in the front of the camera, see "Front View" on page 7, emits a red light by half pressing the Shutter button allowing the camera to focus easily.

To set AF Lamp

1. From the Record menu, select **AF Lamp**.
2. Use the ▲ or ▼ keys to go through the selection.
3. Press the **OK** button to save and apply changes.

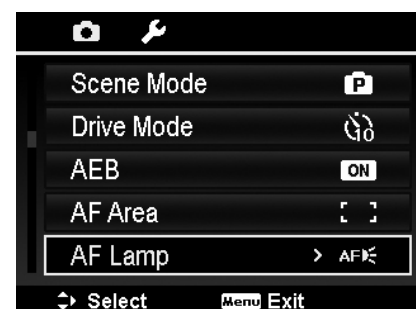

Setting Sharpness

This function allows you to enhance or soften finer details of your images.

To set Sharpness

1. From the Record menu, select **Sharpness**.
2. Use the ▲ or ▼ keys to go through the selection.
3. Press the **OK** button to save and apply changes.

The table below shows the available Sharpness settings.

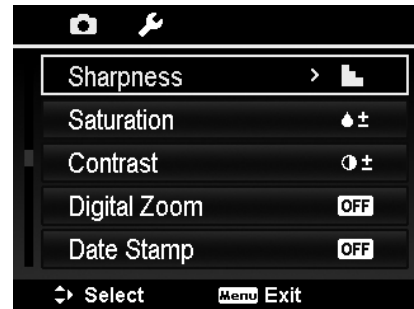

Icon	Item	Description
	High	Sharpens the image.
	Normal	Normal sharpness.
	Low	Softens the image.

Setting Saturation

The Saturation function lets you adjust the color saturation in your images. Use a higher saturation setting for rich colors and a lower saturation setting for more natural tones.

To set Saturation

1. From the Record menu, select **Saturation**.
2. Use the ▲ or ▼ keys to go through the selection.
3. Press the **OK** button to save and apply changes.

The table below shows the available Saturation settings.

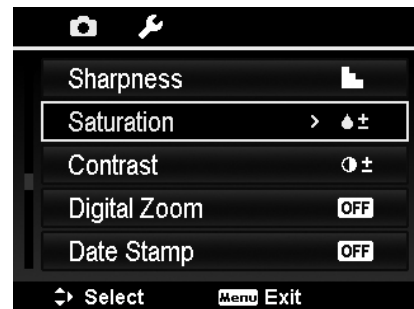

Icon	Item	Description
	High	Enhance the saturation.
	Normal	Normal saturation.
	Low	Reduce the saturation.

Setting Contrast

This function allows you to adjust the contrast of your images.

To set Contrast

1. From the Record menu, select **Contrast**.
2. Use the ▲ or ▼ keys to go through the selection.
3. Press the **OK** button to save and apply changes.

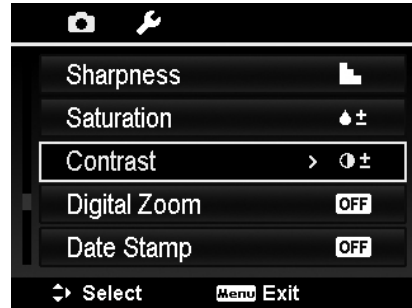

Icon	Item	Description
	High	Enhance the contrast
	Normal	Normal contrast
	Low	Reduce the contrast

Setting the Digital Zoom

This feature controls the digital zoom mode of your camera. Your camera enlarges an image using the optical zoom first. When the zoom scale exceeds 5X, the camera uses digital zoom.

To set Digital Zoom

1. From the Record menu, select **Digital Zoom**.
2. Use the ▲ or ▼ keys to go through the selection.
3. Press the **OK** button to save and apply changes.

The table below shows the available Digital Zoom settings.

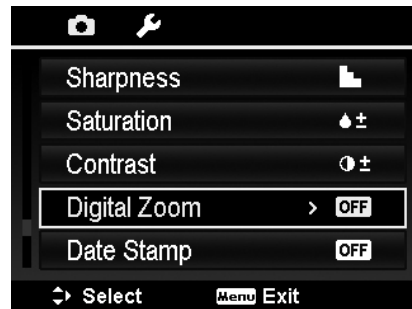

Icon	Item	Description
	Intelligent Zoom	Enlarges the image digitally with almost no distortion. This feature is available for still images only.
	Standard Zoom	Enlarges all image sizes up to a maximum of 5x in preview, but the image quality deteriorates.
	Off	Uses the optical zoom only.



- Digital Zoom is not available in Face tracking on, Movie, and Voice Recording modes.
- The maximum Intellect zoom scale varies depending on the image type and resolution.

Setting the Date Stamp

The date of recording can be printed directly on the still images. This function must be activated before the image is captured. Once date and time are stamped on an image, they can no longer be edited or deleted.

Limitations of Date Stamp functions are as follows:

- Available for still images only.
- May slow down AEB/ Burst mode when Date Stamp is enabled in AEB/ Burst mode.
- In vertical or rotated images, the date and time on your images still appear horizontally.

To set Date Stamp

1. From the Record menu, select **Date Stamp**.
2. Use the ▲ or ▼ keys to go through the selection.
3. Press the **OK** button to save and apply changes.

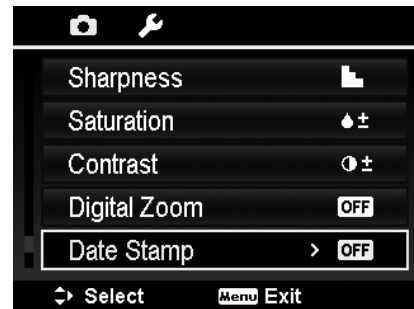

Setting Auto Review

The Auto Review function lets you view the captured image right after shooting it.

If Auto review is On, the camera will display the captured image for **1 second** on the LCD monitor.

To set Auto Review

1. From the Record menu, select **Auto Review**.
2. Use the ▲ or ▼ keys to go through the selection.
3. Press the **OK** button to save and apply changes.

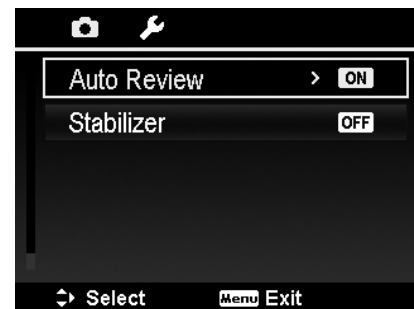

Setting Stabilizer

This function allows you to prevent blurred images caused by shaking.

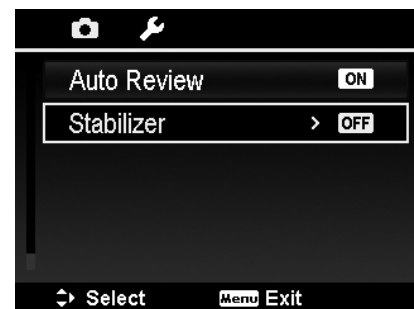

1. Enable the **Stabilizer** under the **Record Menu**.
2. Use the ▲ or ▼ keys to go through the selection.
3. Press the **OK** button to save and apply changes.



Recording Videos

You can record videos with the camera, the available recording time depends on the capacity of the memory card. Videos can be recorded until the maximum memory capacity has been reached. However the length of a single video may be limited (the limitation depends on the camera model).



1. Turn on the camera and press **Menu button**  to launch record menu.
2. Select **"Movie"** from scene mode menu.
3. Focus your camera on the subject that you want to take.
4. Press the **Shutter button** to start recording.
5. Use the **Zoom button** to zoom in and zoom out an image.
6. To pause recording, press the key .
7. To continue recording, press the key  again.
8. To stop recording, press the **Shutter button**.



- When the camera stop recording due to reaching maximum capacity (**4GB**) for a single video, simply press the Shutter button again to continue recording.
- The camera will automatically stop recording when the memory capacity is full.
- Digital zoom is not available while recording a video.
- Sound cannot be recorded while using zooms (Pressing the **Zoom button**.)
- Power save mode is not available in video recording or pause recording.

Settings of Recording Videos



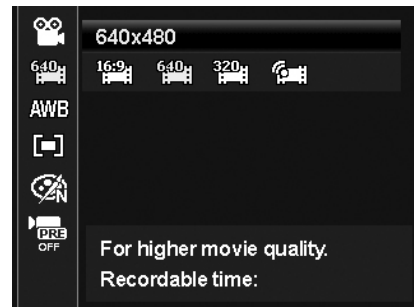

Press **Function button** to enable video setting menu before recording a video.

Movie Size

The Movie Size function appears only in Movie mode. Use this function to adjust the resolution and quality of movie clips.



The table below shows the available size and corresponding image quality settings.

Icon	Item	Description
	1280 X 720	HDTV (Support SDHC_Class(6)) The length of a single video recording is up to 29 minutes. It will automatically stop recording if time is over.
	640 X 480	High Quality
	320 X 240	Normal
	Web	For Internet, see "Internet Mode" on page 42 below.

Internet Mode

The Internet Mode allows you to record videos with predefined video settings for easy upload to the Internet website.

Therefore when you record using the Internet Mode, the following standards are followed:

- Recorded videos are set to Internet standard resolution of 640 X 480.
- Recording automatically stops when the file reaches 1 GB.
- Available recording time for Internet Mode is up to 10 minutes.

White Balance, Metering, Color Mode

To set above settings, please refer to "Using the Function Menu" on page 21.

Pre-Record

You can catch the first three seconds of action you would have potentially missed. Once enable this function, the camera starts recording video automatically before pressing Shutter button. As soon as the Shutter button is hit, the most recent three seconds of video is added to the beginning of the clip.

Display the icon in red while turning Pre-Record on.



Pre-Record will be canceled in the following situation:

- Switch to Photo mode or Playback mode.
- Turn the unit off.
- Enter USB mode

Playback



You can playback the still images, video and audio clips on the LCD monitor.

Viewing in Single Navigation

The Single navigation mode displays the image one by one on the LCD monitor. To view images/videos/audio clips, follow the steps below.

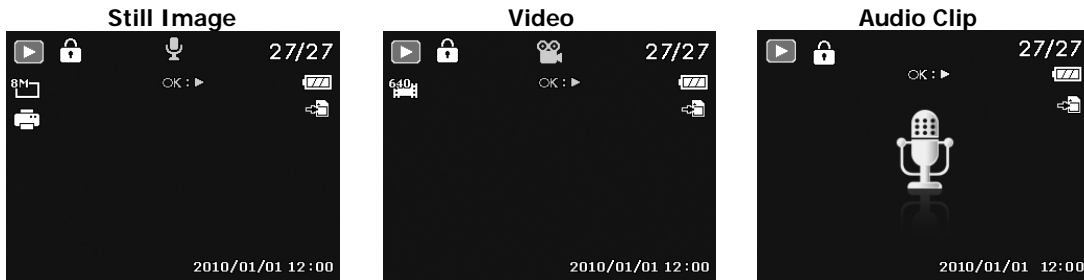
1. Press the **Playback** button  on the camera.
2. The LCD monitor displays an image. To understand the icons and other information on the screen, please see "Photo Mode Screen Layout" on page 13.



3. Use the  or  keys to view next/previous image/video/audio.
4. To play a video or audio clip, press the **OK** button. See "Playing Videos" on page 44 and "Playing Voice Recording" on page 45 for more details.

Viewing Thumbnails

This function allows you to view 9-thumbnail images or by calendar mode on the LCD monitor at the same time. Searching numerous of images is much easier than single view navigation.

To set 9-images mode

1. Set the camera to Playback mode .
2. Press the **Zoom button** counterclockwise (left) **once** to enter 9-images mode.
3. Use the navigation controls to move through the items.
4. Press the **OK** button to select the image and view it normally.

Scroll bar.

If scroll bars appear, it indicates that the screen can be scrolled.

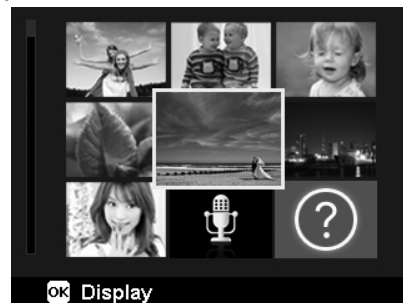

Thumbnail view

To set calendar mode

1. Set the camera to Playback mode .
2. Press the **Zoom button** counterclockwise (left) **twice** to view thumbnails in calendar mode.
3. Use the navigation controls to move through the items.
4. Press the **OK** button to select an image and view it normally.





In calendar mode:

- The first file (Including image, video, audio and error file) recorded on each date appears on the screen.
- Press the **Zoom button** clockwise (right) would back to 9-images mode.

Thumbnail icons:

When you view the thumbnails, some images may contain icons. These icons indicate the type of file or recording.

Icon	Type	Description
	Voice Record	Indicates a voice recording file.
	File Error	Indicates an error file.

Zooming images

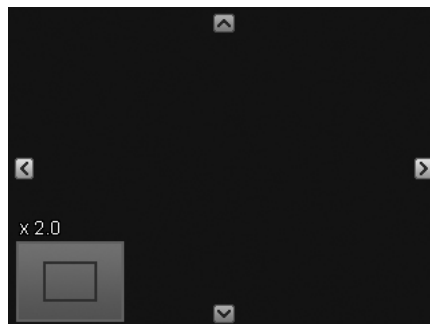

The zoom view function works with still images only.

- In normal view, press the **Zoom button** clockwise (right) repeatedly until the desired zoom view.
- The 4 arrows on the LCD monitor indicate that the image is zoomed in.
- You can zoom to view an image of up to 12X.
- Use the navigation controls to view the zoomed image.
- Press the **Menu** button to close zoom view.



For 320 x 240 resolution images, you can only zoom in up to 6X.

Playing Videos

1. Set the camera to Playback mode .
2. Use the navigation controls to scroll through the saved images. A video clip has a video icon displayed on screen.
3. Press the **OK** button to play the video.
4. During playback, press and hold the **◀** or **▶** keys to fast forward or rewind the video. The camera supports forward and rewind speed of up to 4x.
5. During playback, use the **Zoom button** to control volume. Press clockwise (right) to increase volume/Press counterclockwise (left) to decrease volume.
6. Press the **▲** key to pause playback. Press the key **▲** again to resume. When paused, the play info will remain on screen except **WT** .
7. To forward or rewind the video frame by frame, press the key **▲** to pause playback, then press the **◀** or **▶** keys.
8. Press the **▼** key to stop the playback. The LCD monitor displays the video frame image in Single navigation mode.



- The play info, except the icon **WT** , will be displayed when the video is paused, during REW/FF or frame by frame modes
- Volume cannot be adjusted when paused or during REW/FF modes.

To capture screenshot image from a video clip

1. During playback of video, press the key ▲ to pause playback on your desired video frame to capture.
2. Press the **Shutter button** to capture a screenshot.
3. The camera stop playback. The LCD monitor displays the captured image in Single navigation mode.



This feature does not function when pressing shutter key and PV displays memory full or the folder cannot be created msg.

Playing Voice Recording

1. Set the camera to Playback mode ▶.
2. Use the navigation controls to scroll through the saved images. When viewing a voice recording file, the LCD monitor displays the screen layout of Audio clips. See picture on the right.
3. Press the OK button to play the voice recording.
4. During playback, use the **Zoom button** to control volume. Press clockwise (right) to increase volume/Press counterclockwise (left) to decrease volume.
5. Press the ▲ key to pause playback. Press the ▲ key again to resume. When paused, the play info will remain on screen except **WT** 🔊.
6. Press the ▼ key to stop the playback. The LCD monitor displays the image in Single navigation mode.

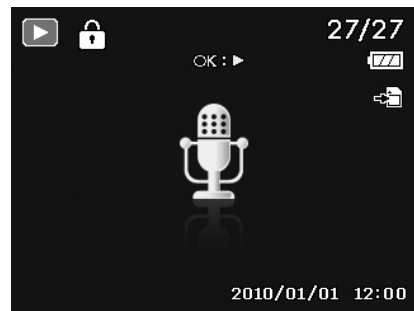

Volume cannot be adjusted during Pause mode.

Playing Voice Memo

Voice memo is separately recorded and attached to a captured image. See "Voice Memo" on page 50 on how to record voice memo.

1. Set the camera to Playback mode ▶.
2. Use the navigation controls to scroll through the saved images. An image file with voice memo has a voice memo icon located on the top center of the LCD monitor. See picture on the right.
3. Press the OK button to play the voice recording.
4. During playback, use the **Zoom button** to control volume. Press clockwise (right) to increase volume/Press counterclockwise (left) to decrease volume.
5. Press the key ▲ to pause playback. Press the key ▲ again to resume. When paused, the play info will remain on screen except **WT** 🔊.
6. Press the key ▼ to stop the playback. The LCD monitor displays the image in Single navigation mode.



Volume cannot be adjusted when you pause the voice memo.

Deleting an Image/Video/Audio

There are two ways to delete an image/video/audio:

- Using the **Delete** button.
- Using Playback Menu Delete settings. See "Delete" on page 47.

Using the Delete Button



Use the **Fn/Delete** button on your camera to delete an image/video/audio clip.

1. Set the camera to Playback mode .
2. View images/videos/audio clips in Single navigation mode.
3. Use the ◀ or ▶ keys to scroll the display.
4. When the desired image/video/audio clip is displayed on the LCD monitor, press the **Fn/Delete** button.
5. A confirmation selection appears on screen.
6. Select **Delete**.
7. Press the **OK** button to delete.
8. The next image is displayed on the LCD monitor. To delete another file, use the ◀ or ▶ keys to scroll through the images/videos/audio clips. Then, repeat steps 6 to 7.
9. To close the Delete function and go back to the single navigation mode, select Cancel.

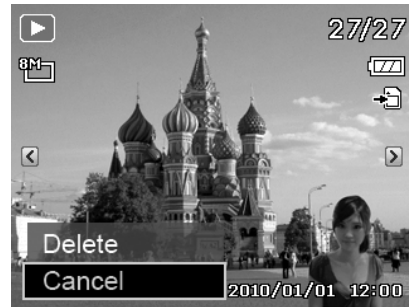

Locked files cannot be deleted at any time. When you try to delete a locked file, the camera displays "File Locked" message on the LCD monitor.

Playback Menu

The Playback menu allows you to edit images, record voice memo, and setup playback settings.

To go to Playback Menu:

1. Press the **Playback** button  on the camera.
2. Press **Menu** button to launch the Playback Menu.
3. Use the ▲ or ▼ keys to move through the menu selections.
4. To select a menu, press ▶ or the **OK** button.
5. Change the submenu settings using the 4-way navigation control.
6. Press the **OK** button to save and apply settings.

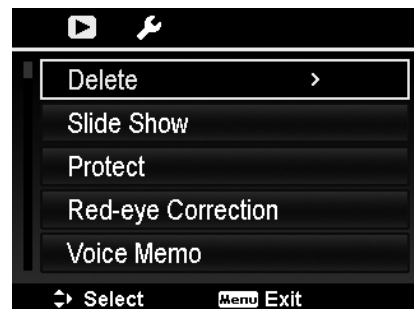

Delete

The Delete function allows to remove unwanted files in the internal memory or on the memory card. Protected files cannot be erased, to delete, unprotect the file first. See "Protect" on page 49.

To delete an image/video/audio clip:

1. From the Playback menu, select **Delete**.
2. The Delete submenu is displayed on the LCD monitor.
Available select settings:
 - **Single**. Select one file to delete.
 - **Voice Only**. Delete only the attached voice memo, not voice clips. The image is still retained in the memory.
 - **Multi**. Select multiple files to delete at the same time.
 - **All**. Delete all files.

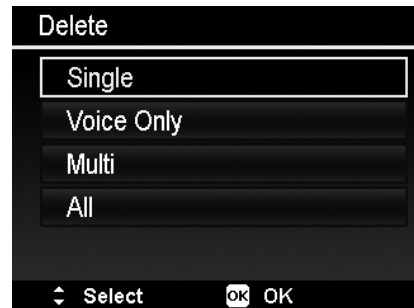

To delete a single file:

1. Select **Single** in the Delete submenu, the images are displayed on the LCD monitor in single navigation mode.
2. Use the ◀ or ▶ keys to scroll the display.
3. When the desired image/video/audio clip is displayed on the LCD monitor, select **Delete**.
4. Press the **OK** button to delete.
5. The next image is displayed on the LCD monitor. To delete another file, use the ◀ or ▶ keys to scroll through the images/videos/audio clips. Repeat steps 3 to 4.
6. To close the Delete function and go back Playback menu, select **Cancel**.

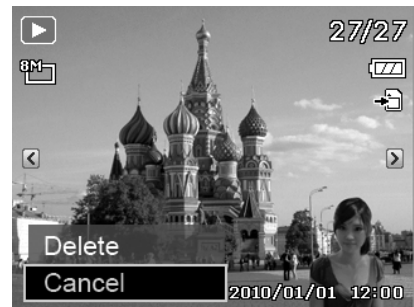

To delete attached voice memo:

1. Set the camera to Playback mode ▶.
2. View images/videos/audio clips in Single navigation mode.
3. Use the ◀ or ▶ keys to scroll until the desired image with voice memo is displayed on the screen.
4. Press **Menu** button to launch the Playback Menu.
5. Use the ▲ or ▼ keys to move through the Playback menu selections then select **Delete**.
6. From the Delete submenu, select **Voice only**.
7. A confirmation selection appears, select **Yes**.
8. Press the **OK** button to delete the attached voice memo and go back to Playback mode.



The Voice Only submenu is disabled if the current image displayed, at the time you access the Delete menu, does not have any attached voice memo.

To delete multiple files:

1. Select **Multi** in the Delete submenu, the images are displayed in thumbnail view on the LCD monitor.
2. Use the navigation control to move through the files.
3. When the desired image/video/audio clip is highlighted, press the **OK** button to mark image/video/audio clip for deletion.
4. Repeat step 3 until all desired images for deletion are marked.
5. Press the **MENU** button. A confirmation selection appears.
6. Select **Yes** to confirm.

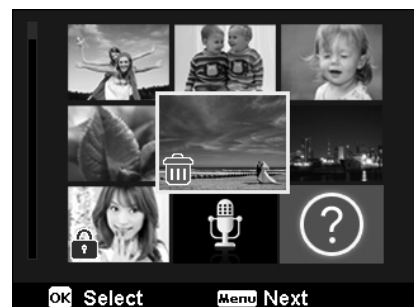

7. Press the **OK** button to delete marked files.

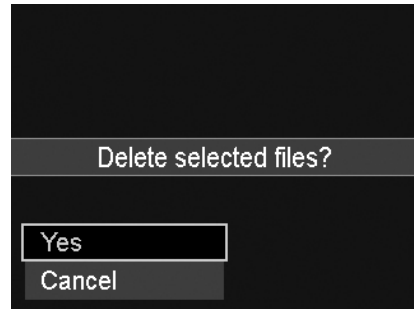

To delete all files:

1. Select **All** in the Delete submenu. A confirmation message appears.
2. Select **Yes**.
3. Press the **OK** button to delete all files.

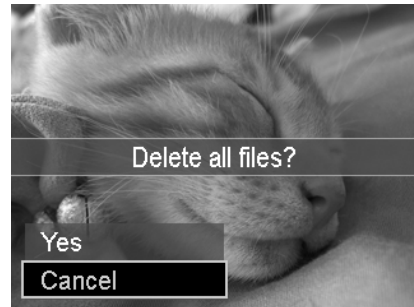

Slide Show

The slide show function enables you to playback your still images automatically in order one image at a time.

To view slideshow:

1. From the Playback menu, select **Slide Show**. The Slideshow menu appears.
2. Set the slide show settings.
3. Select **Start**, then press the **OK** button to start the slide show.
4. During slideshow, press the **OK** button to pause slide show.
5. Use the **▲** or **▼** keys to move through the options. Select whether to **Continue** or **Exit** the slide show.
6. Press the **OK** button to apply selected option.

To change slide show settings:

1. From the Slide show menu, use the **▲** or **▼** keys to move through the selections.
2. Select Interval setting. Press the **◀** or **▶** keys to adjust. Choose among the available interval settings: 1 sec., 3 sec., 5 sec., and 10 sec.
3. Select Transition setting. Press the **◀** or **▶** keys to adjust. Choose among the available transition settings:

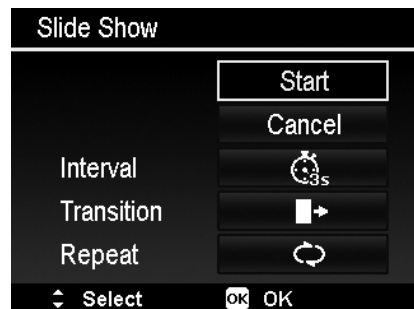
4. Select Repeat setting. Press the **◀** or **▶** keys to adjust. Available settings are: Yes, No.



Protect

Set the data to read-only to prevent images from being erased by mistake.

A protected file has a lock icon  when viewed on Playback mode.

To protect files:

1. From the Playback menu, select **Protect**.
2. The Protect submenu is displayed on the LCD monitor.
Available select settings:
 - **Single**. Select one file to lock/unlock.
 - **Multi**. Select multiple files from the thumbnail view to lock/unlock.
 - **Lock All**. Lock all files
 - **Unlock All**. Unlock all files.

To protect/unprotect a single file:

1. Select **Single** in the Protect submenu, the images are displayed on the LCD monitor in single navigation mode.
2. Use ◀ or ▶ keys to scroll the display.
3. When the desired file is displayed on the LCD monitor, press the **OK** button to select **Lock/Unlock**.
4. To close the protect/unprotect function and go back Playback menu, select **Exit**.

To protect/unprotect multiple files:

1. Select **Multi** in the Protect submenu, the images are displayed in thumbnail view on the LCD monitor.
2. Use the navigation control to move through the files.
3. When the desired file is highlighted, press the **OK** button to mark/unmark the file clip for protection.
4. Repeat step 3 until all desired files to protect are marked.
5. Press the **MENU** button. A confirmation selection appears.
6. Select **Yes**.
7. Press the **OK** button to lock files and go back to Playback mode.

To protect all files:

1. Select **Lock all** in the Protect submenu. A confirmation message appears.
2. Select **Yes**.
3. Press the **OK** button to lock all files.

To unlock all files:

1. Select **Unlock all** in the Protect submenu. A confirmation message appears.
2. Select **Yes**.
3. Press the **OK** button to unlock all protected files.

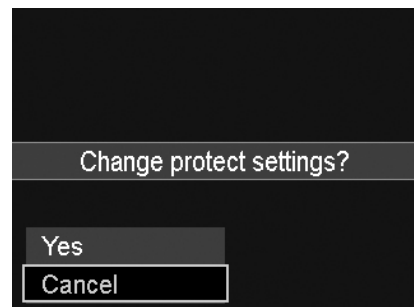
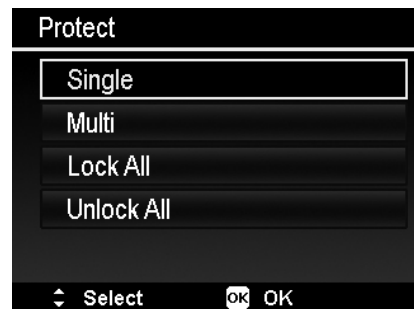
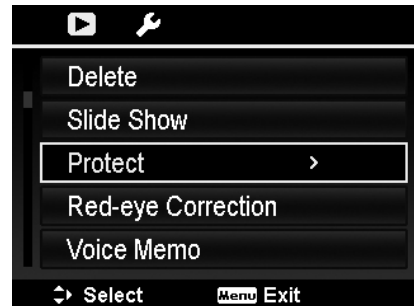

Red-eye Correction

The Red-eye Correction function is used to reduce red eye in captured images. This function is only available for still images. Red-eye correction can be applied to an image several times, but the quality may gradually deteriorate.

To activate Red-eye Correction:

1. Set the camera to Playback mode .
2. Press the ◀ or ▶ keys to scroll and select an image.
3. Press the **MENU** button to launch the Playback menu.
4. Select **Red-eye Correction**.
5. Select **Start**.
6. Press the **OK** button to start correction.
7. After completing Red-eye correction, a menu selection appears. Select whether to:
 - **Overwrite**. Save and replace old file with a new one.
 - **Save As**. Save the new file as a new one.
 - **Cancel**. Cancel red-eye correction.
8. Press the **OK** button to save/cancel changes.

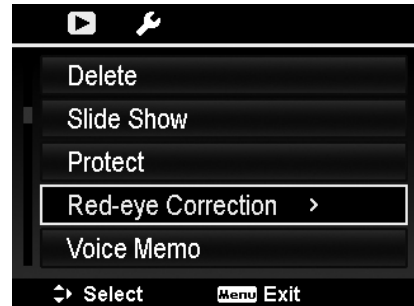

Voice Memo

A maximum of 30 seconds of audio can be recorded as a memo for captured still images.

To record voice memo:

1. Set the camera to Playback mode .
2. Press the ◀ or ▶ keys to scroll and select an image to attach voice memo to.
3. Press the **MENU** button to launch the Playback menu.
4. Select **Voice Memo**.
5. Select **Start**, then press the **OK** button to start recording.
6. Press the **OK** button again to stop recording.

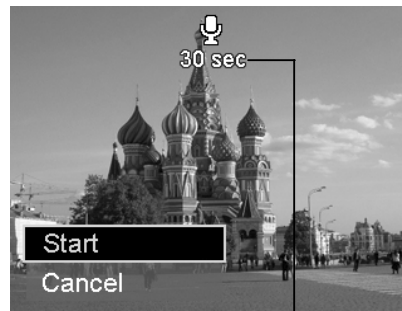
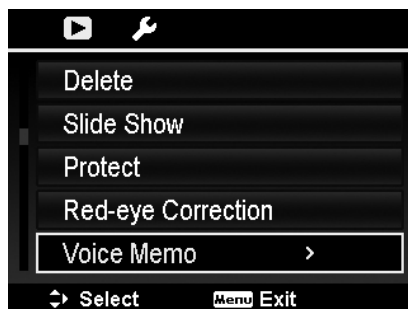

Time left (n seconds) for recording.



When you record voice memo to an image with an existing voice memo, the old recording file would be replaced by the new one.

Color Mode

The Color Mode function lets you adjust edit still images to apply different colors or tones for a more artistic effect. Edited images in this function are saved as a new file.





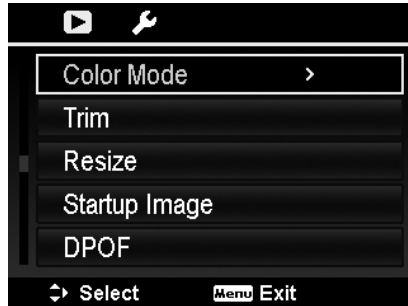



To activate Color Mode:

1. Set the camera to Playback mode .
2. Press the ◀ or ▶ keys to scroll and select an image to edit.
3. Press the **MENU** button to launch the Playback menu.
4. Select **Color Mode**. The Color Mode submenu appears.



5. Press the ◀ or ▶ keys to scroll and select an option. As you move through the selection, the preview on the LCD monitor changes synchronously.

The succeeding table shows the available settings.

Icon	Item	Description
	Normal	No effect is added to the image.
	Sepia	Image is saved with a sepia tone.
	B&W	Image is saved in black and white.
	Negative	Image appears to be the opposite of the original image.
	Mosaic	Image is saved with mosaic tiles.
	Vivid Red	Image is saved with reddish tint.
	Vivid Green	Image is saved with greenish tint.
	Vivid Blue	Image is saved with bluish tint.

Trim

The Trim function allows you to trim an image to another image size. This function is only available for still images.

To trim an image:

1. Set the camera to Playback mode .
2. Use the ◀ or ▶ keys to scroll and select an image to trim.
3. Press the **MENU** button to launch the Playback menu.
4. Select **Trim**. The Trim screen layout is displayed on the LCD monitor.
5. Use the **Zoom button** to change size as zoom in/out.

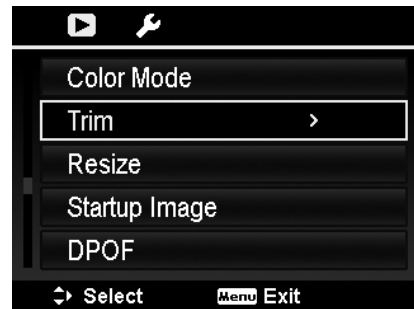

No.	Description
1	Enlarged image
2	4-way indicator
3	Trimmed size
4	The approx. location of the trimmed area
5	Image area



6. Use the navigation controls to move the image.
7. Press the **OK** button to apply changes. A menu selection appears.
8. Select whether to:
 - **Overwrite**. Save and replace the old file with the new one.
 - **Save As**. Save the new file as a new one.
 - **Cancel**. Cancel Trim.
9. Press the **OK** button to save/cancel changes.



- Trim function is not available for images with image size set to VGA.
- All images will be trimmed in 4:3 ratio regardless of its original image ratio.

Resize

Resizes a previously saved image and only resizing to a smaller size is available.

To resize an image:

1. Set the camera to Playback mode .
2. Use the ◀ or ▶ keys to scroll and select an image to resize.
3. Press the **MENU** button to launch the Playback menu.
4. Select **Resize**. The Resize submenu is displayed on the LCD monitor.
5. Select size among: 8M, 5M, 3M, and VGA. Available size settings may vary depending on original image size. Unavailable settings appear as gray icons in Resize submenu.
6. After selecting size, a menu selection appears. Select whether to:
 - **Overwrite**. Save and replace old file with a new one.
 - **Save As**. Save the new file as a new one.
 - **Cancel**. Cancel resize.
7. Press the **OK** button to save/cancel changes.

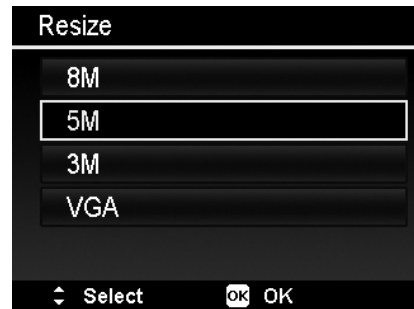

Resize function is not available for images with image size set to VGA.

Startup Image

You can specify the startup image from the captured images for camera.

1. Press the **MENU** button to launch the Playback menu.
2. Select **Startup Image**. The menu selection appears.
3. Select options:
 - **System**. Use camera default image.
 - **My Photo**. Use the ◀ or ▶ keys to scroll and select desired image.
 - **Off**. Disable the startup image.
4. Press the **OK** button to apply changes.

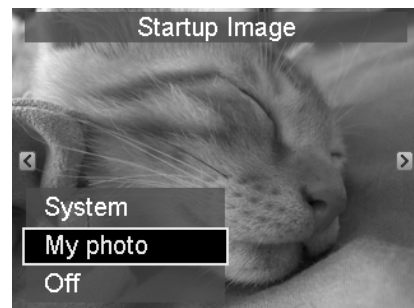

The startup image will still be displayed startup even if the selected image was deleted.

DPOF

DPOF is the abbreviation for Digital Print Order Format, which allows you to embed printing information on your memory card. You can select the images to be printed and how many prints to make with the DPOF menu in the camera and insert the memory card to the card compatible printer. When the printer starts printing, it will read the embedded information on the memory card and print the specified images.

To set DPOF:

1. Press the **MENU** button to launch the Playback menu.
2. Select **DPOF**. The submenu appears. Available settings are as follows:
 - **Single**. Select a single image to mark.
 - **All**. Mark all images in the memory card.
 - **Reset**. Reset all DPOF settings to initial default settings.

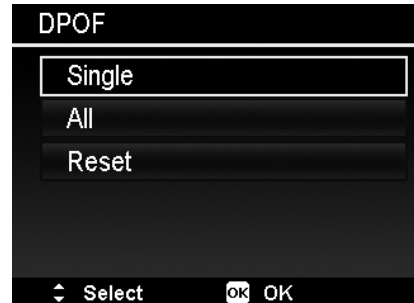

To set DPOF on a single image/all images:

1. Select **Single** or **All** on the DPOF submenu.
2. For single image, use the ◀ or ▶ keys to scroll and select an image to mark for printing.
3. Specify the number of copies. Use the ▼ or ▲ to increase/decrease number.
4. Press the **Function/Delete** button to toggle between turning on/off the date stamp.
5. Press the **OK** button to save DPOF settings.



To reset DPOF:

1. Select **Reset** on the DPOF submenu. A confirmation message appears.
2. Select **Yes**.
3. Press the **OK** button to reset DPOF settings.



Radial Blur

The Radial Blur is an effect creates blurs around a point.

To set Radial blur for an image:

1. Use the ▼ or ▲ keys to specify the level of blurs. The adjusting result on preview synchronously while selecting the level.
2. Press the **OK** button to proceed save options.
3. Available settings are as follow:
 - **Overwrite**. Save and replace the old file with a new one.
 - **Save As**. Save the new file as a new one.
 - **Cancel**. Cancel Radial blur.

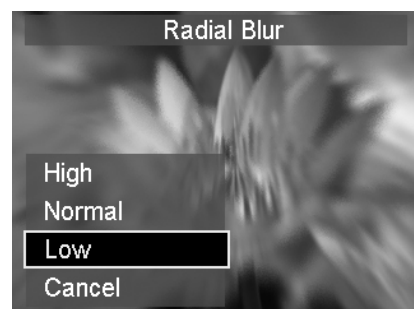

Using the Setup Menu

You can access the Setup menu whether you are in Record or Playback mode. The Setup menu allows to configure general camera settings.

To go to Setup Menu:

1. Press **Menu** button to launch the Record/Playback Menu.
2. Use the ◀ or ▶ keys to switch the menu tab to **Setup** menu.
3. Use the ▼ or ▲ keys to move through the menu selections.
4. To select an item, press the **OK** button or ▶ key.
5. Change the submenu settings using the 4-way navigation control.
6. Press the **OK** button to save and apply settings.



Setting Sounds

Use the Sound menu functions to control the sounds produced by the camera.

1. From the Setup menu, select **Sounds**.
2. Adjusts sound settings.
3. Press the **OK** button to apply changes.

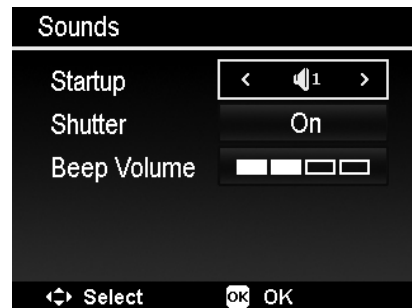

Item	Available Settings	Description
Startup	Sound 1, Sound 2, Sound 3, Off	Selects the startup sound when camera is turned on.
Shutter	On, Off	Enables or disables shutter sound when Shutter button is pressed. Shutter sound is not available when recording videos or voice clips.
Beep volume	0-4	Adjusts volume.

Setting Power Save

The Power Save function allows you to set an idle time after which the camera automatically sets to sleep mode to save power. After a minute of being in sleep mode, the camera eventually turns off power.

This function is not available in the following instances:

- Recording a video or audio file
- Playing a slideshow/video/audio file
- Using the USB connector

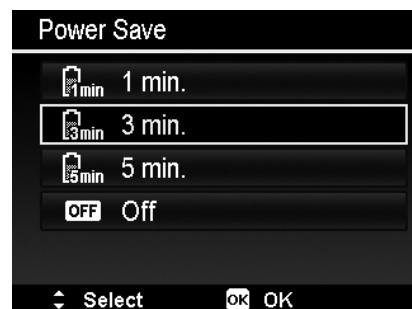

Setting LCD Save

Enable the LCD Save function to automatically decrease the LCD brightness to conserve battery power. When the camera is idle for 20 seconds, the LCD darkens. Press any button to resume to normal brightness.

- The camera is idle when no buttons are pressed. LCD Save, though enabled, does not function during video playback, slideshow and video recording.

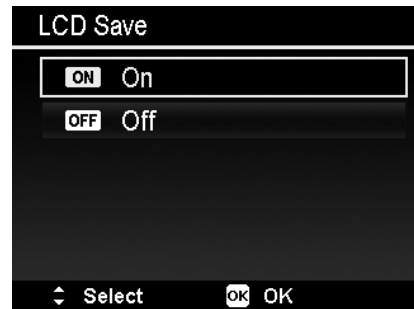

Setting Date & Time

Use the Date & Time function to set the date and time of your camera. This function is useful in attaching date stamps on captured images. Your camera uses a 24-hour time format.

1. Press the navigation controls to adjust date and time value. By holding down the ▼ or ▲ keys, the numeric values changes continuously.
2. Press the **OK** button to apply changes.

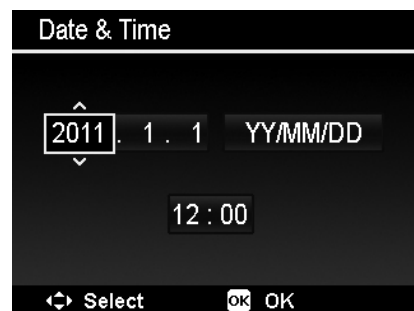

Setting Language

Specify in which language menus and messages are to be displayed on the LCD monitor.

1. Use the navigation control to scroll through the list and select the desired language.
2. Press the **OK** button to confirm and apply settings.



Setting File Numbering

This function allows you to select the method in which to assign file numbers to images.

Available settings are:

- **Series.** Assigns number to files in sequence even if the folder is changed.
- **Reset.** The file numbering will start from 0001 each time the folder is changed and "Format" is processed.

To understand folder and file structure of your camera, see "About Folder and File Names" on page 61.

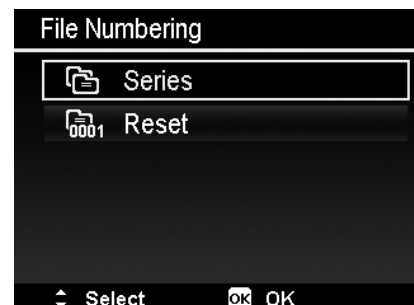

Setting TV Out

Use the TV Out function to adjust video output signal to accommodate different regional settings. If TV out is not set correctly, the image may not display properly on TV.

Available settings are:

- **NTSC.** Applicable in Japan, USA, Canada, Taiwan and others.
- **PAL.** Applicable in Europe, Asia (excluding Taiwan), Oceania and others.

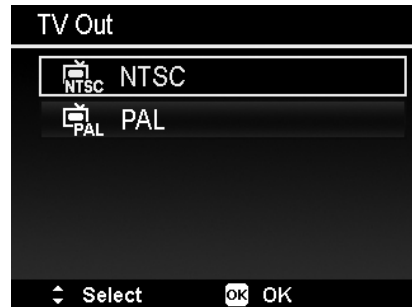

Setting LCD Brightness

Select a brightness level for the LCD monitor.

Available settings are:

- **Auto.** Auto detects the LCD brightness.
- **Bright.** Enhance the LCD brightness.
- **Normal.** Normal LCD brightness.

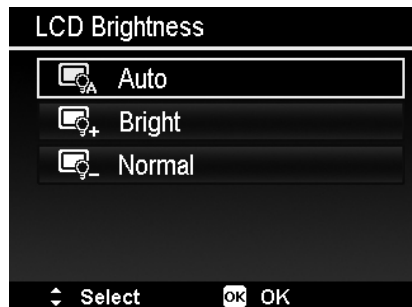

Setting Memory Kit

This utility formats the internal memory (or memory card) and erases all stored images and data.

Available settings are:

- **Format.** Select to format currently used memory.
- **Copy to Card.** Select to copy all files stored in the internal memory to the memory card.

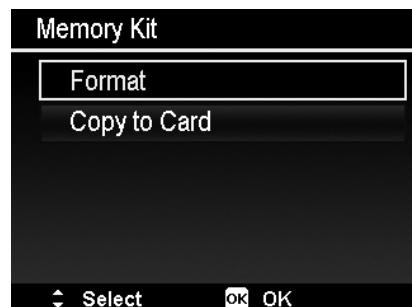

- If the images were saved in the internal memory when inserting memory card into the camera. You can use **Copy to Card** function in order to copy all images from the internal memory into memory card.
- If there is no memory card or the internal memory is empty or plug in lock card, the Copy to Card function is disabled.

Reset All

Use this function to reset the camera to its factory settings. However, the following settings are exceptions and not affected by Reset.

- Date & Time
- Language
- TV Out
- Custom White Balance data



Making Connections

You can connect your camera to: TV, computer, or a printer.

Connecting the Camera to a TV

You can play back your images on a TV screen. Before connecting to any video devices, make sure to select NTSC/PAL to match the broadcast standard of the video equipment you are going to connect to the camera.

To connect your camera to a TV:

1. Turn on the camera.
2. Set the TV out to match the TV's video out format. See "Setting TV Out" on page 57.
3. Connect the USB/AV 3-in-1 cable to the USB port on the bottom of your camera.
4. Connect the other end of the cable to the TV's AV input port.
5. The LCD monitor turns black and all images and video clips are displayed on the TV.

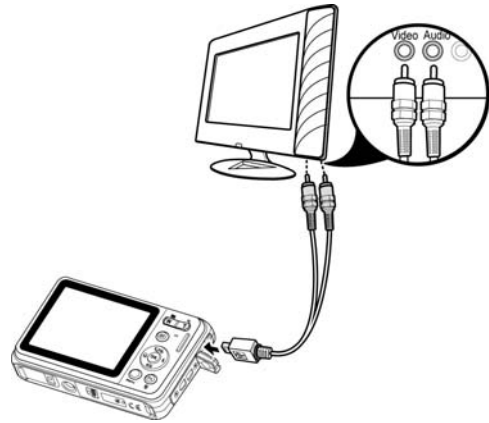

Connecting the Camera to a PC

You can transfer images, videos and audio files to your PC.

1. Connect one end of the USB cable to an available USB port on your computer.
2. Connect the other end of the USB cable to the USB terminal on the camera.
3. Turn on the camera.



4. The USB mode menu appears on the screen. Select **Computer** by using the ▲ or ▼ key and press the **OK** button.

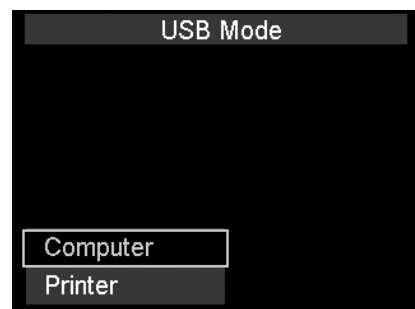

5. The PC starts to detect the connection while the LCD monitor appears **Connecting...**



6. Connection established after **PC MODE** appeared on the LCD monitor

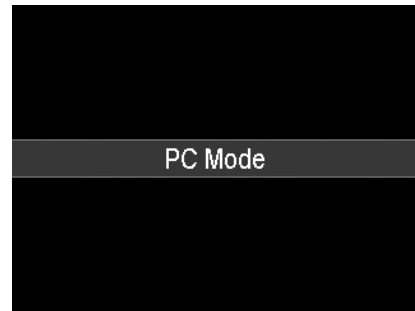

7. Access the files in the camera by your PC.



- The camera's internal memory and memory card would display as removable drives in PC.
- After the connection, no image is displayed on the LCD monitor.

Connecting the Camera to a Printer

You can print your images directly using a **PictBridge compatible** printer.

1. Turn on your Printer. Check that the printer is turned on, there is paper in the printer, and there are no printer error messages.
2. Connect one end of the USB cable to the printer while the other end to USB terminal on the camera.
3. The USB mode menu appears on the screen. Select **Printer** by using the ▲ or ▼ key and press the **OK** button.
4. Enter the print mode and print the selected images.

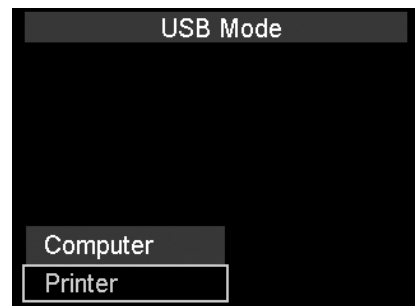
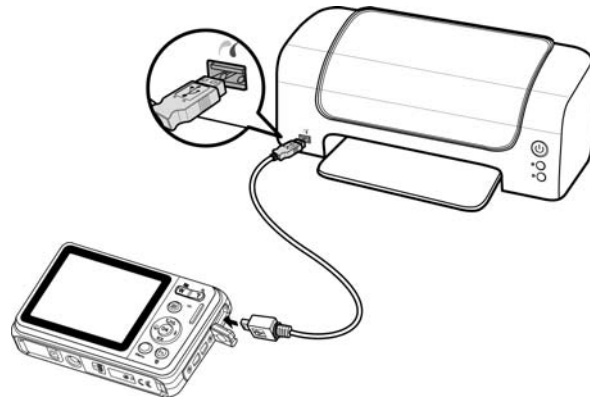

For details on the following page "Setting the Print Mode Menu".

Setting the Print Mode Menu

Print Mode menu appears on the screen after the connection between a printer and your camera is established.

Print Mode includes three major settings:

- **Print Select.** An image can then be selected to print.
- **Print All.** Prints all images.
- **Print Index.** Prints all images as thumbnails.

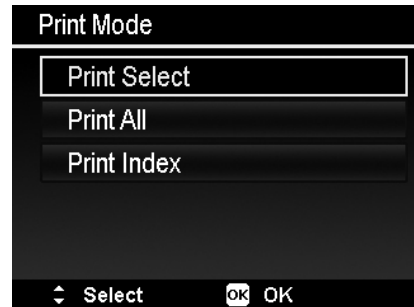

To set Print Select

1. Use the ◀ or ▶ keys to scroll and select an image for printing.
2. Specify the number of copies. Use the ▼ or ▲ key to increase/decrease number.
3. Press the **Function/Delete** button to toggle between turning on/ off the date stamp.
4. Press the **OK** button to enter printer settings.

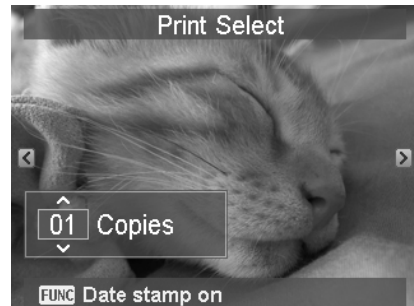

To set Print All and Print Index

Repeat the same steps 2 to 4, then enter printer settings.

To set Printer Settings

1. Use the ▼ or ▲ key to specify a print option.
2. Modify paper size and quality by the ◀ or ▶ keys.
Available setting:
 - Paper size: Default / A4 / 4"x6"
 - Quality: Default / Fine / Normal
3. Select **Print** on the screen for printing.
Or **Cancel** to go back Print Mode.

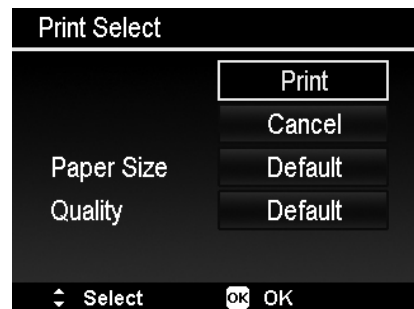

Start Printing

- LCD monitor appears "Now printing...".
- Or press Menu button to stop printing anytime.

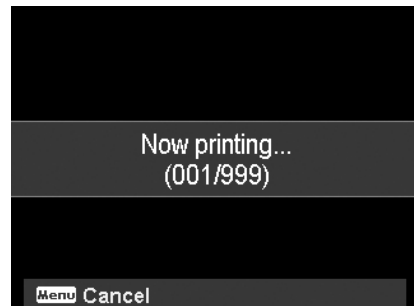

Appendix

About Folder and File Names

Your camera automatically creates specific directory of folder in the internal memory cards to organize captured images, videos and audio files.

File Naming

File names begin with "DSCI" and followed by a 4-digit number that increases in sequence. File numbering starts from 0001 when a new folder is created.

If the highest folder number is 999 and the highest file number exceeds 9999, the camera will display the warning message "Folder cannot be created". When this happens, try one of the following ways:

- Reset the file number. See "Setting File Numbering" on page 56.



Do not change the folder and file names in the memory card using your PC. It may be unable to playback the data using the camera.

Troubleshooting

Problem	Cause and/or Action
Camera does not turn on.	The batteries may be exhausted. Charge or replace the batteries.
Camera turns off automatically.	Press Power button to turn on the camera.
LCD turns dark.	Press any button except the Power button to turn on the LCD.
Empty battery icon is displayed on the LCD, then the camera turns off.	Batteries are exhausted, please replace or recharge.
LCD monitor displays "No image".	There is no image file in the memory card. Image file format may not be supported.
LCD monitor displays "Not available for this file".	Function is only available for specific file types. File format is not supported.
LCD monitor displays "Memory full".	Memory card is full. Replace the memory card with a new one or delete unnecessary images.
LCD monitor displays "File locked".	This file is locked. Unlock the file. See "Protect" on page 49.
LCD monitor displays "Card locked".	The memory card is protected. Remove the card and slide the write-protect switch to its unlock position.
LCD monitor displays "Format error".	The card may be damaged. You can either change the card or wipe to clean the connected points.
LCD monitor displays "Copy error".	The memory card is protected. Remove the card and slide the write-protect switch to its unlock position. The memory card is full. Replace card or delete unnecessary files.
No image displays on the TV screen.	Incorrect TV-out type was selected. Set the correct TV-out type to match your TV system.
The lens got stuck up.	Do not force the lens to go back. The type of the battery used may be incorrect or the battery power level is too low. Change the battery or charge the battery before using the camera.

Specifications

Sensor	Panasonic 14M 1/2.3-type
Lens	Focal Length: 4.51 (W) ~ 18.04 (T) mm 4X optical zoom, 5x digital zoom
LCD monitor	2.7" Color LCD
Focusing Range	Normal: Wide: 10cm~infinity Tele: 10cm~infinity Macro: 1cm~50cm (Super Macro: 1cm)
Aperture	3.1~5.9
Shutter	Shutter Speed: Auto: 1 - 1/2,000 sec. Manual: 15 - 1/2,000 sec. Night: 15 - 1/2,000 sec. Fireworks: 2 sec.
File Format	Still Image: EXIF 2.2 compatible format (JPEG compression) Video: AVI (MJPEG) Audio: WAV
Resolution (Photo)	14M (4320 x 3240), 3:2 (4320 x 2880), 8M (3264 x 2448), 5M (2592 x 1944), 3M (2048 x 1536), 16:9 (1920 x 1080), VGA (640 x 480)
Resolution (Movie)	<ul style="list-style-type: none"> • 1280 x 720 (16:9) (Support SDHC_Class(6)) • 640 x 480 • 320 x 240 • 640 x 480 (Web)
Scene Mode	Auto, Movie, Program, Intelligent Scene, Portrait, Landscape, Sunset, Backlight, Kids, Night Scene, LOMO, Fireworks, Snow, Sports, Party, Candlelight, Night Portrait, Soft Skin, Flowing Water, Food, Building, Text, Foliage, Auction, Smile Capture, Blink Detection, Pre-Composition, Love Portrait, Self Portrait, D-Lighting, Fisheye Lens, Photo Stitch, Aperture Priority, Shutter Priority, Manual Exposure, Voice Recording.
ISO Equivalent	Auto, 100, 200, 400, 800, 1600, 3200 (3M, 16:9 <2M>, VGA), 6400 (3M, 16:9 <2M>, VGA)
White Balance	Auto White Balance, Daylight, Cloudy, Tungsten, Fluorescent 1, Fluorescent 2, Custom
Exposure Control	+2.0EV / +1.7EV / +1.3EV / +1.0EV / +0.7EV / +0.3EV / 0EV / -0.3EV / -0.7EV / -1.0EV / -1.3EV / -1.7EV / -2.0EV
Metering	Multi, Center, Spot
Drive Mode	Off, 10 sec., 2 sec., Double, Burst, Speedy Burst
Flash	Auto, Red-eye Reduction, Forced On, Slow Sync, Forced Off
Color Mode (Preview)	Normal, LOMO (Only support Movie mode), Vivid, Sepia, Color Accent (Red), Color Accent (Green), Color Accent (Blue), B&W, Vivid Red, Vivid Green, Vivid Blue
Color Mode	Normal, Sepia, B&W, Negative, Mosaic, Vivid Red, Vivid Green, Vivid Blue
Storage	Internal memory: 32MB flash memory External memory: SD (up to 4GB), SDHC card (up to 32GB guaranteed), SDXC card (up to 64GB guaranteed)

OSD Language	English, Français, Español, Deutsch, Italiano, Русский, Português, Português BR, Nederlands, Türkçe, Polski, Magyar, Rumänisch, Čestina, Български, Croatian, Slovensky, Slovenščina, Ελληνικά, Svenska, Norsk, Suomi, Danish, عربي, Indonesia, Malay, ไทย, 日本語, 한국어, 简体中文, 繁體中文
Interface	USB/AV OUT
TV system	NTSC/PAL (selected by Setup MENU)
Battery	Lithium ion battery
Operating Temperature	0° C - 40° C
Operating Humidity	0% - 90%
Microphone	Built-in
Speaker	Built-in
Dimensions	99.1 x 22 x 61.4 mm
Weight	140 g (no battery)

Rollei
since 1920

RCP-Technik GmbH & Co. KG
Tarpn 40/Gebäude 7b
D-22419 Hamburg
Hotline +49 (0)6 31/3 42 84 49
welcome@rcp-technik.com
www.rollei.com

Subject to technical changes!

