

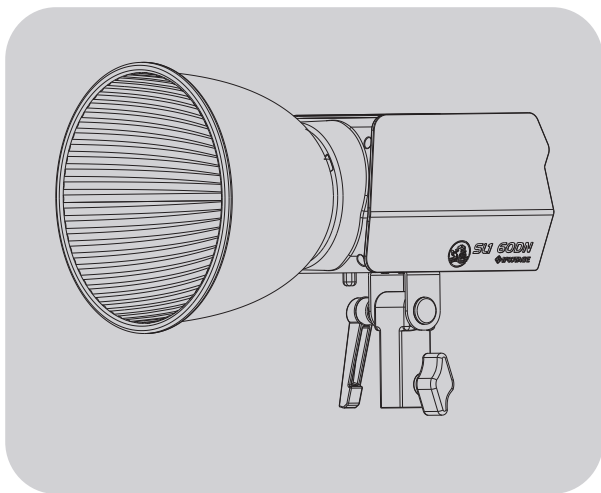

## SL1 60DN LED Light User Manual



 **IFOOTAGE**

3DK1463001

Thank you for purchasing this iFootage product. This manual provides important user information for the Anglerfish SL1 60DN LED Light . Please read the manual carefully before operating the equipment and keep the manual safe for future reference.

The Anglerfish SL1 60DN is a convenient and versatile LED light suitable for both video and photography production and features brightness adjustment, 5600K colour temperature, 8 different special effects, mobile device APP connectivity providing multiple settings including key frames. The SL1 60DN is compact enough to carry, cool enough to be hand held and can be attached to a light stand, magic arm or other support equipment. This flexible and compact light is perfect for both studio and location recording.

## Contents

■ Features	1
■ Component Description	2
■ Operating Description	3
■ Mode Selection	4
■ Menu Bar	5
■ Power Management	6
■ Bluetooth Connectivity	7
■ APP Introduction	8
■ Accessory Installation	9
■ How to Use	10
■ Product Parameters	11
■ Notes	12
■ Maintenance	12
■ Statement	13
■ Manufacturer Information	13

## Features

- The 60DN light is compact, portable, has fully adjustable angles, provides simple onboard controls as well as App control and can be used hand held or on a stand or with any other suitable support equipment.
- The 60DN provides a natural spectrum light source, RA 98, high colour fidelity, realistic and saturated colour IES TM30-18 index, Rf 97 and Rg100.
- The 60DN offers 8 different special lighting effects designed to suite various scenarios.
- There are 4 types of dimming curves to choose from.
- Connecting to the App via Bluetooth will provide further functions such as key frames, multi-lamp control and music mode.
- Key frame and sequence dimming are fully adjustable and can be preset to suit user requirements.
- Equipped with silent fans the 60DN will automatically adjust fan speed to accommodate the temperature of the light.
- The product has a 'High Temperature' warning function.

## Precautions:

1. Keep dry. Do not expose the product to water, liquids, rain or moisture either whilst in use or when in storage. It is recommended that the product should not be handled using wet hands.
2. Do not disassemble or modify the product. Mishandling, including dropping the product, may result in permanent damage.
3. Please keep this product out of the reach of children and animals.
4. Do not use or store the light in the vicinity of harmful chemicals or combustible materials. Always read the warning labels prior to using the product.
5. Please use appropriate adapters for power supply and PD-100 adapters for Type-C supply ensuring the correct voltage, current and temperature specifications and range. Maximum brightness using a 65w and above adapter is 60%.
6. The effectiveness of the lamp will be impaired if the heat sink is blocked or covered.

## Component Description

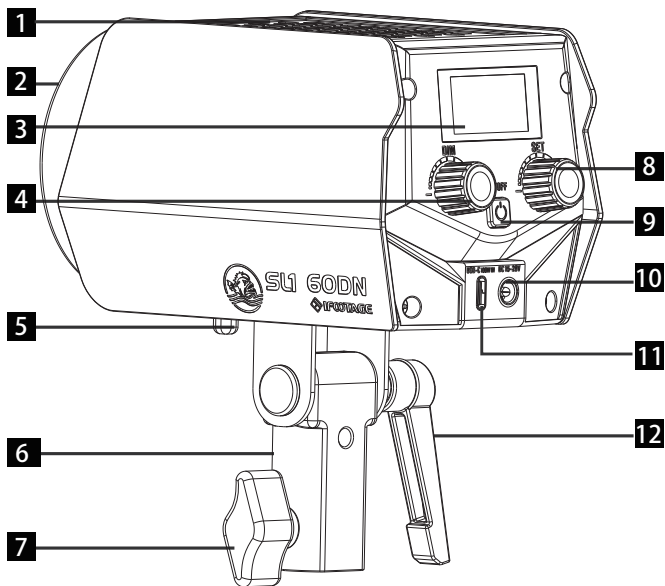

- |                         |                                      |                                   |
|-------------------------|--------------------------------------|-----------------------------------|
| <b>1</b> Heat sink      | <b>5</b> Reflector Release Button    | <b>9</b> Power Button             |
| <b>2</b> Light Head     | <b>6</b> Adjustable Handle           | <b>10</b> DC Power Connection     |
| <b>3</b> Display        | <b>7</b> Light Stand Locking Control | <b>11</b> Type-C Power Connection |
| <b>4</b> Dimmer Control | <b>8</b> SET Control                 | <b>12</b> Angle Locking Control   |

# Operating Description

## ■ Controls Description

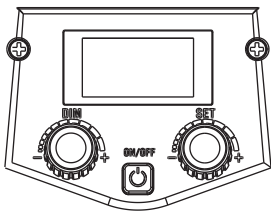

ON/OFF Button:

Long press: On / Off

Short press: Temporarily turns light off/on

Dimmer Control:



Rotate to adjust brightness



Press repeatedly to use preset brightness: 20%, 40%, 60%, 80% and 100%.

Pressing the Dimmer Control will exit silent fan mode.

SET Control:



Long press: return to the previous level menu



Press: go to the next level menu / switch between sub-menu options



Rotate: move up and down options / switch between modes

## ■ Screen Description

Bluetooth Dimming Curve Fan Speed / Device ID Code Switch

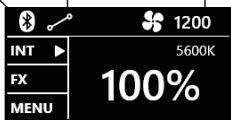

Main Menu Bar

Sub-menu Bar

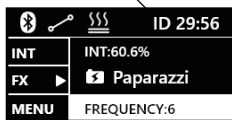

Parameters

# Mode Selection

## ■ Light brightness mode

In the main menu bar, press SET to select brightness, fixed at colour temperature 5600K±200.

**DIM**  
 Rotate the dimmer control to adjust brightness.

**DIM**  
 Press the dimmer control to cycle through brightness at 20% increments.

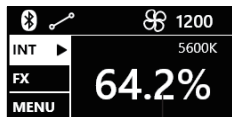

Brightness Percentage

## ■ Special Effect Mode

There are 8 special effects including: paparazzi, fireworks, lightening, strobe light, welding light, faulty bulb, pulsing and explosion. The corresponding parameters can be adjusted according to the effect being used.

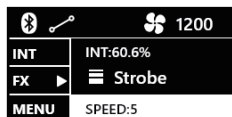

Adjustable Parameter Values      Special Effects Status

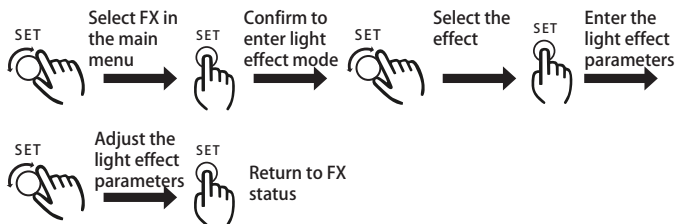

**DIM**  
 In lighting effect mode, rotating the dimmer control will adjust brightness.

# Menu Features

## Fan speed adjustment

Fan speed can be adjusted to suit usage. There are 2 fan settings: 'Silent' and 'automatic'.

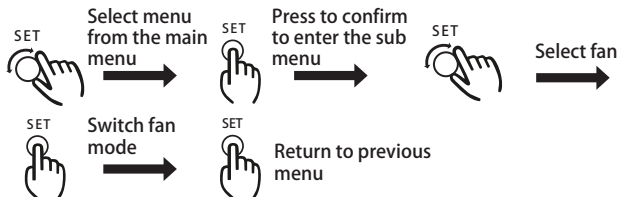
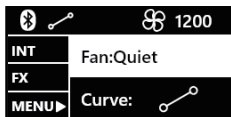

Whilst in silent mode, pressing the Dimmer Control will exit silent fan mode.

Note: Do not block or cover the heat sink and always ensure the light has adequate air circulation.

## Dimming Curve

This is a means of pre-setting the dimming light function using one of four dimming curves: linear, exponential, logarithmic and S-curve. Each one provides an alternative type of dimming.

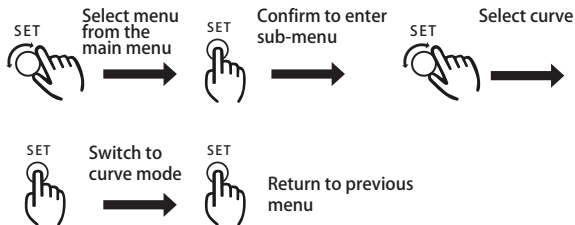
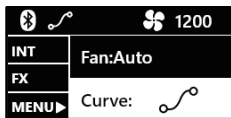

## Menu Features

### Language Settings

On the device screen, select Menu→press SET to enter sub-menu→select language by rotating SET→press SET to switch between Chinese and English.



### Restore Factory Settings

On the device screen, select Menu→Press SET to enter sub-menu→select Restore Factory Settings by rotating SET→Press SET to confirm. Restoring factory settings will delete all data set by the user, so please use it carefully.



## Power Management

### Power Supply

DC Power Port: DC15-20V

Type-C Port: PD3.0 20V = 5A

### Temporary Lamp Shutoff

Press the power button to turn the light off, and press the power button again to turn the light on. Temporary light shutoff is a low-power mode. When the product is not in use, please check to make sure the product is fully shut down.



### High Temperature Alert

When the display shows the 'Overheating Protection' warning, the brightness will be reduced. It is recommended to turn the lamp off, and then continue to use after the overall temperature of the light has reduced. Long-term use of this product in high temperature conditions will affect the life of the device.

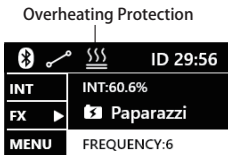



# Bluetooth Connection

## ■ Bluetooth Connection and Reset

1. For Bluetooth connection: download the iFootage Lumin App to your mobile device (Smartphone or tablet). Once registered, open the Lumin App and create a new project. Open the project and search for devices, select the appropriate device using the device name or code to connect via Bluetooth. The light will blink three times to show a successful Bluetooth connection. Via the project device list, select to control single or multiple devices. The Bluetooth icon will appear on the status bar after which you can set the internal lighting values. If the APP shows Bluetooth connection failure, please check to see that your mobile device is Bluetooth enabled or reset Bluetooth on the product and try to reconnect.
2. Bluetooth Reset: On the device screen select Menu within the main menu bar and press SET to enter the sub-menu. Then select Bluetooth Reset by rotating the control and press SET to confirm.

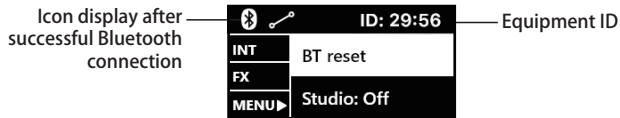

### Note:

1. The 60DN and mobile device connection use Bluetooth BLE5.1 technology. Prior to opening the App to connect please ensure that Bluetooth has been enabled on your device. If using Android, you will need to enable Bluetooth on the APP also.
2. The iFootage Lumin App currently supports iOS 12.0 and above. It also supports mobile devices with Android 8.0 and above.
3. After connecting the device to the Lumin App via Bluetooth please ensure that, when prompted to make a firmware update, the battery power for all devices is sufficient to support the duration of the update.

# APP Introduction

## ■ APP Overview

The Lumin App has multi-light control, keyframes and music mode. For additional modes please download the iFootage Lumin App or visit [www.footagegear.com](http://www.footagegear.com) to access a detailed App user guide. To download the APP, please scan the QR code or search for iFootage Lumin App. For more information please visit [www.footagegear.com](http://www.footagegear.com) after registering you can operate the product using the APP, however should you change to another mobile device, the product will be reset via Bluetooth, after which you can use the APP connection.



APP QR Code



Official Website QR Code



## ■ Keyframes and Sequences

Within the Lumin App you can select the key frame settings within modes. You can apply key frames to layout, loop method, fade time, duration etc to achieve a repeatable lighting status or set of lighting conditions.

## ■ Multi-light Control

Within the App's project device list, you can choose to add multiple lights to a project. By setting key frames on each light you can create a multiple light sequence.

## ■ Music Mode

Music mode has a variety of ambient colours that react and change according to the music.

## ■ Special Effects

The iFootage Lumin APP has 8 internal effects, and more parameters can be set in the APP according to your lighting needs.

## Accessory Installation

The SL1 60DN LED light comes with its own Mini Bowens adapter and can be used with other light accessories which accommodate a Mini Bowens adapter such as Fresnel attachment, 60cm softbox or beauty dish etc.

### ■ Reflector Installation

To attach the reflector, the three tabs must be aligned with the lamp head and then rotated to lock it in place.

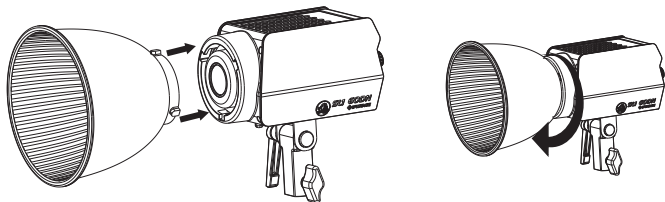

### ■ Reflector Removal

Push the reflector release on the lamp head and rotate the reflector anti-clockwise to remove.

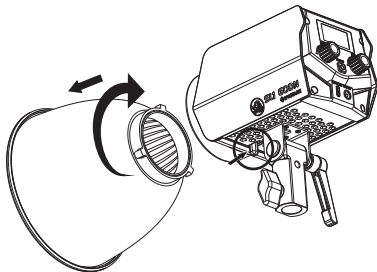

# How to Use

## ■ Adjustable Spotlight Angle

The angle of the light can be easily adjusted by turning the angle handle anti-clockwise and then locking back in place by turning clockwise.

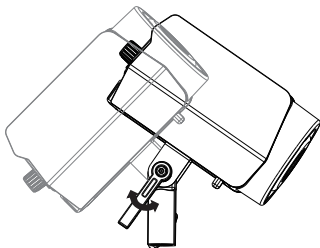

## ■ Usage

The 60DN can be used hand held or attached to a light stand or other suitable support accessory.

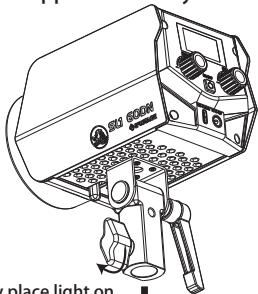

Securely place light on light stand and lock in place using the light's locking control.



Light stand spigot

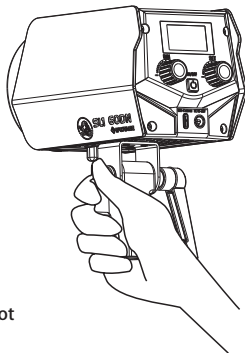

## Product parameters

Product Name	LED Light
Model	SL1 60DN
Adapter voltage	AC 100V-240V
Light body working voltage	DC 15-20V
Overall Power	86W
Light output power	70W
Materials	Aluminum alloy, stainless steel, PC
Bare Light Size	154 X 152 X 96 mm
Bare Light Net Weight	760g
Working Temperature	-15°C~45°C
SSI CIE-D55 *	84
IES TM-30 *	Rf97 Rg100
CQS *	97
CRI *	98
TLCI *	99
Colour temperature*	5600K±200
Brightness Range	0%~100%
100% Illuminance *	≈3000LUX (main lamp, distance 1 meter)
100% Illuminance *	≈12200LUX (with reflector, distance 1 meter)
Control Method	Bluetooth APP control, manual button control
Wireless Frequency	2.4GHz
Bluetooth transmission distance	15meters (no interference)
Display Type	Monochrome OLED

\*Note: The above data is based on iFootage Lab tests and there may be some variation in values with data marked with an asterick \*

## In the box

SL1 60DN Main Light Body, Reflector, 5m Power Cable, Power Adapter, Light Stand Adapter Screw, Warranty Card, User Manual, Certificate.

## Notes

1. In order to avoid equipment failure, please do not expose this product to moisture or use in wet or rainy, sandy or dusty environments.
2. Do not disassemble or modify the product. Mishandling, including dropping the product, may result in permanent damage.
3. Keep this product and its parts out of the reach of children and animals.
4. Please ensure that the product is always free from moisture and is stored safely. Water and other liquids may contain minerals that can corrode the internal electronic circuits.
5. Avoid using or placing the product in high temperature environments, including direct strong, sunlight, as this may shorten the life of electronic parts, damage the battery or distort plastic parts or casings.
6. Avoid using the product in very low temperature environments as internal condensation or water particles may damage electronic circuitry as the temperature rises.
7. Avoid using or storing the product in dirty or dusty environments as this may damage components.
8. Avoid placing the product on or near hot surfaces or sources of heat such as lit cigarettes, naked flames or heating systems.
9. During use do not cover the light head with flammable materials.
10. To avoid burns, please do not handle the light if it is hot.

## Maintenance

1. To prevent the accumulation of dust particles affecting the performance of the product, please carefully wipe the exterior of the product with a clean, soft, dry cloth at regular intervals.
2. The SL160DN LED is covered by a 1-year warranty from the date of original purchase.
3. Product damage or failure to operate caused by inappropriate or irregular operation is not covered by the warranty.
4. Unauthorized repair or attempting repair will make the warranty void and any authorised repair will then be subject to charges.
5. Always use a clean, dry soft cloth to clean the lens on the product. Do not use harmful chemicals, cleaning agents or liquids to clean the product.
6. In the unlikely event that the product is found to be faulty please contact our Customer Service team who will be happy to assist you: [cs@ifootagegear.com](mailto:cs@ifootagegear.com)



## Statement

iFootage reserve the right to amend or rectify all hardware and software specifications at any time without notice. If there appears to be any difference between the contents of the instruction manual and the actual product, please refer to the product itself.

iFootage and its associates will not be held responsible for the use or misuse of any of the iFootage products or any direct, indirect, punitive, incidental, special consequential property or life damage responsibility. The risk of users or any other person using this product shall be borne by the user. This will not affect your legal rights.



iFootage Lumin  
APP QR Code



Official Website  
QR Code

To download the iFootage Lumin APP, please scan the QR code or visit our website. For more information on operation modes please visit our website [www.footagegear.com](http://www.footagegear.com)

## Manufacturer's Information



IFOOTAGE INTERNATIONAL (HK) LIMITED

UK Design & Made in China

Origin: China

Website: [www.footagegear.com](http://www.footagegear.com)

