

A large, light gray, stylized graphic of an eye, showing the iris and eyelid, positioned on the left side of the page.

R72

7 inch 3D-LUT Monitor

[Usage Guide](#)

Contents

- What's in the Box
- Notice
- Quick Start
- Menu Operation Guide
- LUT Import
- Upgrade Instruction
- Menu Guide
- Technical Data
- Disposal and Conformity
- Warranty

WHAT'S IN THE BOX

Before using this product, please check carefully whether everything is in the package. If there is anything missing, please contact us.

1x Field Monitor

1x Storage Bag

1x Cold Shoe

1x Standard HDMI Cable

1x Mini HDMI Cable

1x USB Stick

1x D-Tap Cable

1x Instruction Manual

1x Microfiber Cloth

NOTICE

Thank you for buying this monitor. The content mentioned in this instruction manual concerns your safety and legitimate rights and responsibilities. Please read this instruction manual carefully before using this product to ensure that the product has been properly set up. Failure to follow the instructions and warnings in this instruction manual may cause harm to you and the people around you, and damage the monitor or other surrounding items. The final interpretation rights of this document and all relevant documents of the monitor belong to Shenzhen Bestview Electronics Co., Ltd. as it may be updated without notice. Please visit the official website www.desview.com to get the latest product information.

By using this product, you are deemed to have read the disclaimer and warning carefully, understand and accept all the terms and contents of this statement, and take full responsibility for using this product and possible consequences. You undertake to use this product only for legitimate purposes, and agree to this clause and any relevant regulations, policies and guidelines established by Desview.

Desview is not responsible for any loss of injury or any liability arising from direct or indirect use of the product. Follow all security guidelines, including but not limited to this user manual.

Dimensions

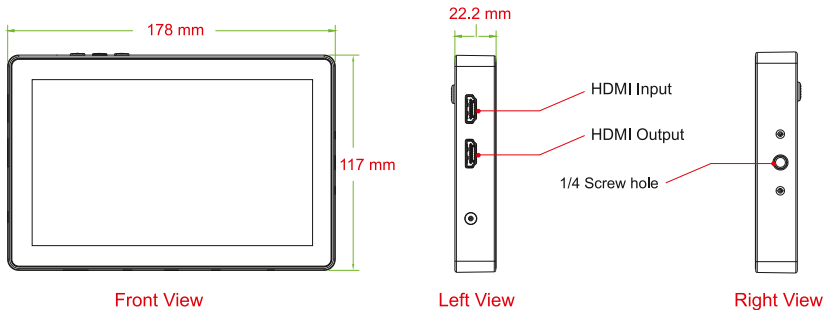

QUICK START

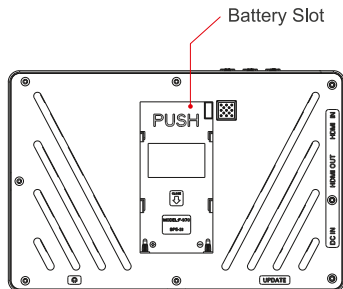

Rear View

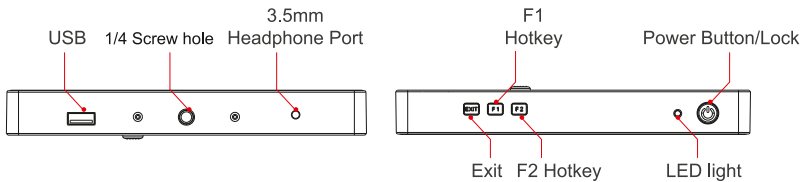

Top / Bottom View

MENU OPERATION GUIDE

Attention: This is a capacitive touchscreen monitor, all option and content in menu can be operated by the touchscreen or the buttons.



Double-tap screen to open the menu.



Touch on the screen beside the menu to exit menu interface.



Pinch to zoom.

LUT IMPORT

1. Copy the Log file into the USB stick.
2. Insert the USB stick into the monitor's USB interface.



3. Find the "Custom Lut_usb" in the LUT config menu, then touch "Search USB".



4. Open the LUT file you find.

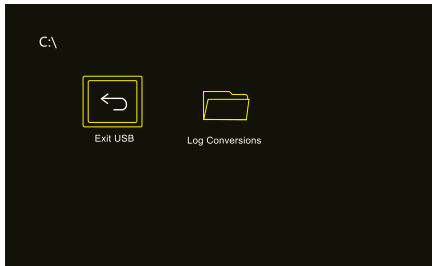

LUT IMPORT

5. Choose the LUT file you need to use, when the icon shows , it indicates that the LUT file has been imported successfully.



6. After import the LUT file, touch "Exit USB", then pull out the USB stick.

UPGRADE INSTRUCTION

1. Copy the downloaded upgrade program into the USB stick.
2. Insert the USB stick into the monitor's USB interface.



3. Find the "Update" in "System config" menu, then touch "OK".

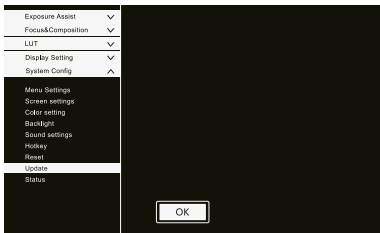

The LED light near the power button will start flashing with red and green color.

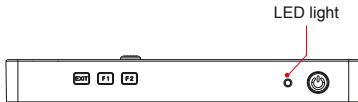

4. The monitor will turn on automatically when the update is finished.

Attention: Don't turn off the power or take out the USB stick during the period of the upgrade.

MENU GUIDE

Exposure Assist ^

False color



Zebra



Histogram



Waveform



Vectorscope

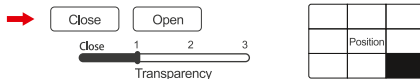

All Wave

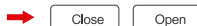

HDR



MENU GUIDE

Focus & Composition ^

Single Color



Peaking

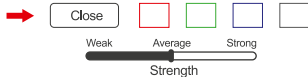

Center Mark



Safe Area



Mark Ratio

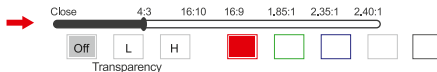

Grid Lines



Audio Meters



MENU GUIDE

LUT Config



LUT



Close

Open

No Data

Custom LUT_ usb



Look USB

Display Setting



Aspect Ratio



Display Flip



Close

Open

Close

Open

H Flip

V Flip

Zoom



Close

Zoom x2

Zoom x4

Pixel-to-Pixel



Close

Open

HV Delay



Close

H Delay

V Delay

H/V Delay

Freeze



Close

Open

Battery notification



Close

Open

Anamorphic



Close

1.33x

1.5x

1.66x

1.79x

2.0x

MENU GUIDE

System Config 

Menu Config

Color

Color Temperature

Backlight

Sound

Hotkey



Reset



Update

Status

Language

→ Duration

→ Brightness  Contrast 

→ Sharpness  Saturation 

→ Color Temperature

Red 

Green 

Blue 

→ Backlight 

→ Volume 

→

→

→

→ Input HDMI | Resolution NO signal | Scan Mode NO signal

Frame NO signal | Color Temperature 6500K | Aspect Ratio Auto

Backlight 80 | Volume 50

TECHNICAL DATA

Screen Size	7 inch
Machine Size	17.8 x 11.7 x 2.22 cm
Weight	380 g
Resolution	1920 x 1200
Contrast	1100:1
Brightness	2600 Nits
Viewing Angle	178°(HN)
Backlight	LED
Material	ABS engineering plastic
Voltage	DC 7 – 24 V
Power	≤ 18 W
Signal Input	HDMI 1.4
Signal Output	HDMI 1.4
Audio Output	3.5 mm stereo headphone jack

HDMI input signal format

720x480i & 720x480p @ 59.94, 60 Hz

720x576i & 720x576p @ 50 Hz

1280x720p @ 50, 59.94, 60 Hz

1920x1080i @ 50, 59.94, 60 Hz

1920x1080psf @ 24, 25, 29.97, 30 Hz

1920x1080p @ 23.93, 24, 25, 29.97,
30, 50, 59.94, 60 Hz

3840x2160p @ 24, 25, 30 Hz

4096x2160p @ 24 Hz

HDMI output signal format

720x480i & 720x480p @ 59.94, 60 Hz

720x576i & 720x576p @ 50 Hz

1280x720p @ 50, 59.94, 60 Hz

1920x1080i @ 50, 59.94, 60 Hz

1920x1080psf @ 24, 25, 29.97, 30 Hz

1920x1080p @ 23.93, 24, 25, 29.97, 30, 50,
59.94, 60 Hz

3840x2160p @ 24, 25, 30 Hz

4096x2160p @ 24 Hz

DISPOSAL AND CONFORMITY



Dispose of packaging: For disposal, separate packaging into different types. Cardboard and board must be disposed of as paper and foil must be recycled.



Disposal of old devices: Applicable in the European Union and other European countries with systems for the separate collection of reusable materials. Do not dispose old devices into the household waste! If the Desview R7Plus is no longer used, every consumer is legally obligated to dispose them separately from the household waste, for example, at a collection site of his community / city district. This ensures that devices are properly recycled and negative effects on the environment are avoided. Therefore electrical and electronic equipment needs to be marked with the shown symbol.

Conformity

The Rollei GmbH & Co. KG herewith declare, that this device "Desview R72" complies with the following guidelines:

2011/65/EC RoHs Directive
2014/30/EU EMC Directive



The complete text of the EU Declaration of Conformity can be downloaded at the following Internet address: www.rollei.com/EGK/DesviewR72

Rollei GmbH & Co. KG, In de Tarpen 42, 22848 Norderstedt, Germany

WARRANTY

Warranty

The statutory liability for defects exists.

The statutory warranty applies to the purchased product, except for consumables and wearing parts, which may also be worn out during the warranty period through proper use. The warranty period is two years from delivery of the goods.

You are obliged to examine the goods immediately and with due care for deviations in quality and quantity and to notify us of obvious defects within 7 days of receipt of the goods in text form (e.g. e-mail), timely dispatch is sufficient to meet the deadline. This shall also apply to hidden defects discovered at a later date. The assertion of warranty claims is excluded in the event of violation of the obligation to examine and give notice of defects.

If an error occurs and this is reported to us before the warranty expires, Rollei GmbH & Co. KG will, at its own discretion,

1. repair the fault free of charge using new or repaired spare parts;
2. replace the product with a product of at least equal performance, either new or made from new or refurbished parts;
3. refund the purchase price of the product.

Warranty Card

USER INFORMATION

Name

Phone:

Add:

SALES INFORMATION

Sale Date:

Distributor Name:

Distributor Tel:

REPAIR LOG

Repair Date:

Repair name:

Issue:

Result: repaired not repaired return

 Desview®

R72

7inch 3D-LUT Monitor

DESVIEW
FIELD MONITOR



Production:
2022/03

Qualified

Imported by:

Rollei

Rollei GmbH & Co. KG

In de Tarpen 42

D-22848 Norderstedt

Service Hotline

+49 40 270750277

