

Rollei

CarDVR-308



USER GUIDE

FOR GERMAN | ENGLISH | FRENCH | SPANISH | ITALIAN | DUTCH

www.rollei.de

Contents

About this Guide	3
Recycling Information	3
Conformity	4
Battery Warning	4
Notes on Installation	5
Caution	6
1 Introduction	7
1.1 Features	7
1.2 Package Contents	7
1.3 Product Overview	8
2 Getting Started	9
2.1 Storage Media	9
2.1.1 Insert the Memory Card	9
2.1.2 Remove the Memory Card	9
2.2 Installing in Vehicles	10
2.2.1 Mount to Windshield	10
2.2.2 Adjust the device position	10
2.3 Connecting to Power	11
2.3.1 Battery Status Indicator	12
2.4 LED Indicator	13
2.5 Powering the Device On / Off and Reset	14
2.5.1 Auto Power On/Off	14
2.5.2 Manual Power On/Off	14
2.5.3 Reset	14
2.6 Initial Settings	15
2.6.1 Set Time Zone	15
2.6.2 Set the Date / Time	17
3 Using the Drive Recorder	18

3.1	Automatic Record	18
3.1.1	The Recording Screen.....	19
3.1.2	Emergency Recording	21
3.2	Add Speed Point	22
3.3	Picture in Video.....	22
3.4	Parking Mode.....	23
3.5	Collision Detection	25
3.6	Playback Videos and Photos.....	26
3.6.1	Playback.....	26
3.6.2	Playback Mode.....	27
3.7	Deleting Files	29
4	Adjusting the Settings	31
4.1	Menu Items	31
5	Connecting to Other Devices	34
5.1	Connecting to the Computer	34
5.2	Connecting to TV	35
6	Installing the Software	36
7	SuperCar.....	37
8	Specifications.....	38

About this Guide

The content in this document is for information purpose and is subject to change without prior notice. We have made every effort to ensure that this User Guide is accurate and complete.

However, no liability is assumed for any errors or omissions that may have occurred.

The manufacturer reserves the right to change the technical specifications without prior notice.

Recycling Information

Dispose of packaging: For disposal, separate packaging into different types. Cardboard and board must be disposed of as paper and foil must be recycled.



Disposal of old devices: Applicable in the European Union and other European countries with systems for the separate collection of reusable materials. Do not dispose old devices into the household waste! If the Rollei CarDVR-308 is no longer used, every consumer is legally obligated to dispose them separately from the household waste, for example, at a collection site of his community / city district. This ensures that devices are properly recycled and negative effects on the environment are avoided. Therefore electrical and electronic equipment needs to be marked with the shown symbol.

Conformity

The Manufacturer hereby declares that the CE marking was applied to the Rollei CarDVR-308 in accordance with the basic requirements and other relevant provisions of the following CE Directives:

- 2011/65/EC RoHs Directive
- 2014/30/EU EMC Directive
- 2014/35/EU LVD Directive
- 2012/19/EC WEEE Directive
- 2014/53/EU RED-Directive



The EC Declaration of Conformity can be requested from the address specified on the Warranty card.

Battery Warning

- ❖ Never dismantle, crush, or pierce the battery, or allow the battery to short-circuit. Do not expose battery being placed in high temperature environment, if battery leaks or bulges, stop continue to use.
- ❖ Always charge using the system. Risk of explosion if battery is replaced by an incorrect type.
- ❖ Keep the battery out of reach of children.
- ❖ Batteries may explode if exposed to open fire. Never dispose of batteries in a fire.
- ❖ **Never replace the battery on your own; have the dealer do it for you.**
- ❖ Disposed of used batteries observing local regulations.

Notes on Installation

1. Before installing the device, measure the front windshield viewing area, make sure not to block driver's front view, install the device below the rearview mirror (the central, higher right position of the front windshield). And we recommend that the sky and the land occupied by the screen 50%, fix the car holder and then adjust the device so that the lane is aligned with the screen. Proper installation enables the device to maximize the efficiency also can enhance the accuracy of LDWS.
2. Make sure that the lens is within the wiping range of the windscreen wiper to ensure a clear view even when it rains.
3. Do not touch the lens with your fingers. Finger grease may be left on the lens and will result in unclear videos or pictures. Clean the lens on a regular basis.
4. Do not install the device on a tinted window. Doing so may damage the tint film.
5. Make sure that the installation position is not hindered by the tinted window.
6. This product is suitable for light windshield or light color heat-resistant film windows, it will affect video quality if install it on the dark windows or dark heat-resistant film windows.
7. Use the products of the attached power charger only, please do not use other brand power charger, in order to avoid equipment burn or cause the battery explosion.
8. The suction cup bracket is designed for temporary mounting and will require periodic re-installation. The adhesive bracket is designed for one time and long term installation. We recommend using the adhesive bracket if permanent installation is desired. We are NOT liable for any damages or data loss due to improper bracket mounting or suction cup bracket losing seal and dropping.

Caution

- ❖ Due to local laws and vehicles safety considerations, do not operate this device while driving.
- ❖ Set up time zone, time and date accurately before you use this device.
- ❖ Please use SuperCar software under the condition that Electronic Map are functioning normally.
- ❖ The firmware function in the device is for reference only, drivers are advised to exercise discretion based on actual road conditions.
- ❖ The results of GPS positioning are only for reference, and should not affect the actual driving situation. The device also cannot ensure the positioning accuracy.
- ❖ GPS positioning accuracy may differ depending on weather and location such as high buildings, tunnels, undergrounds, or forests. GPS satellite signals cannot pass through solid materials (except glass). Tinted window will also affect the performance of the GPS satellite reception.
- ❖ GPS reception performance on each device may differ. The device cannot determine the accuracy of the positioning results from different hardware.
- ❖ The values displayed in this device, such as speed and position, may be inaccurate due to the influence of surrounding environment. They are for your reference only.
- ❖ This product is used only for non-commercial use, within the maximum limits permitted by applicable law. We do not take any responsibilities for the loss of use of the product.
- ❖ This device gets warm when in use; this is normal.
- ❖ Improper use or operation of the product may result in damage of the product or its accessories and void the warranty.

Before you start using the product, it is assumed that you agree to the above statement.

1 Introduction

Thank you for purchasing this advanced drive recorder. This product is specifically designed for real time video recording when driving.

1.1 Features

- SONY Sensor, low light enhancement
- Full HD 1920*1080
- 3.0" TFT-LCD color screen
- 155° Wide angle lens
- Collision Detection, when a collision is detected, the device will automatically trigger the emergency recording
- Parking Mode (Motion detection, Vibration detection)
- Multifunction traffic safety reminder

1.2 Package Contents

The package contains the following items. In case there is any missing or damaged item, contact your dealer immediately.

Drive Recorder



Suction Cup Bracket



CD-ROM



Quick Start Guide



Car Adapter



Note:

We recommend using the adhesive bracket if permanent installation is desired. Do NOT install the bracket in a location that may obstruct your field of view and impact driving safety.

1.3 Product Overview

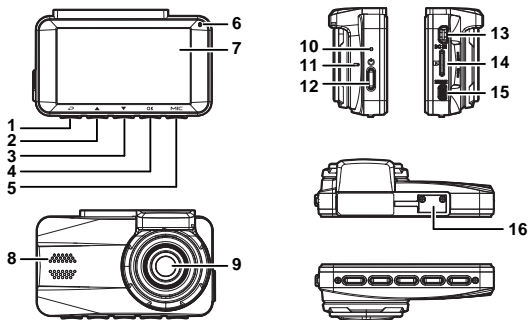

No.	Item
1	Menu / Back Button (☰ / ⬅)
2	Add Speed Point / Up Button (⬆ / ▲)
3	Snapshot / Down Button (📷 / ▼)
4	Emergency Recording / Confirm Button (⚠ / ⓧ)
5	Voice Record Button (👤 / MIE)
6	LED Indicator
7	LCD Color Screen
8	Speaker

No.	Item
9	Wide Angle Lens
10	Reset Hole
11	Microphone
12	Power Switch
13	Power Connector Port
14	Memory Card Slot
15	HDMI Connector Port
16	Bracket Socket

Note:

Please press the button (1~5) according to the diagram notice shown on screen.

2 Getting Started

2.1 Storage Media

2.1.1 Insert the Memory Card

Insert memory card with the pins and the screen of the device facing forward, see the picture as below. Push the memory card in until a click sound is heard, indicating the card is in position.

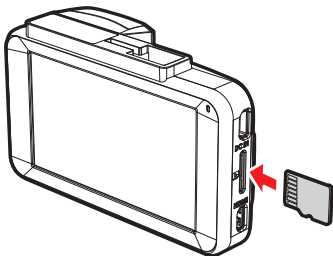

2.1.2 Remove the Memory Card

If the device is power on, please power off first and wait for the procedure of switching off the device completed before press the memory card to eject the slot.

Note:

1. Do not remove or insert the memory card when the device is turned on. This may damage the memory card.
2. Support SDHC class 10 and memory storage 8GB or above (support up to 32GB).
3. Please format the micro SD cards before the initial use. The formatted file type for this device is FAT32 file.
4. When removing the memory card, be careful that the card may spring out and get lost. The memory slot has this spring-out feature for easy removal of the card.

2.2 Installing in Vehicles

2.2.1 Mount to Windshield

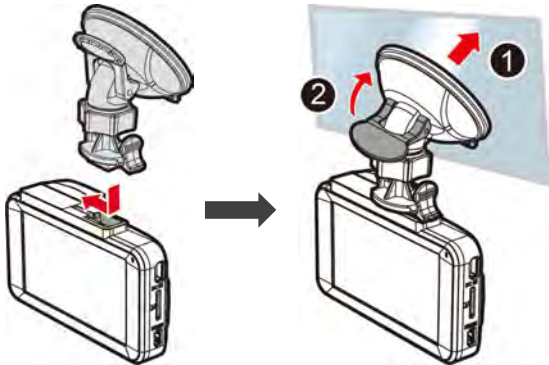

2.2.2 Adjust the device position

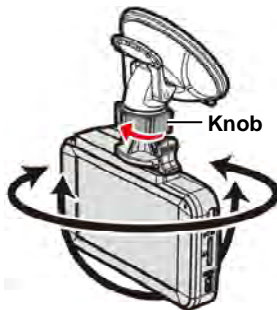

2.3 Connecting to Power

Use only the supplied car adapter to power up this device and charge the built-in battery.

1. Connect one end of car adapter to power connector port on the device. USB port input: DC 5V / 1.0A.

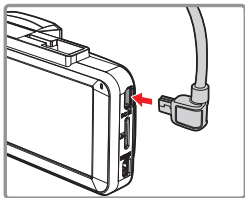



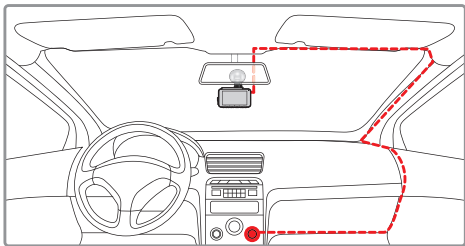



2. Plug the other end of the car adapter to the cigarette lighter socket of your vehicle. Once the vehicle engine is started, the device automatically powers on. Car adapter input: DC 12 / 24V.



Note:

Please measure front windshield viewing area, so as not to block the driver's field of view, and install the device under the driving mirror (upper central of the front windshield). And we recommend that the sky and the land occupied by 50% in the recording screen, please adjust the device so that the alignment icon is aligning the driving lane. Proper installation enables the device to maximize the efficiency and improve the accuracy of LDWS.

2.3.1 Battery Status Indicator

Icon	Description
	Full battery power.
	2/3 battery power.
	1/3 battery power.
	Out of battery power.
	Battery is charging.
	Connect the car adapter to charge the battery, battery is fully charged.

Note:

1. Use the products of the attached car adapter only, please do not use other brand car adapter, in order to avoid equipment burn or cause the battery explosion.
2. Please take note if the environment temperature reaches 45°C or above, the car adapter can still supply power to device, but it will not charge the Lithium-ion battery. This is the characteristic of Li-polymer and is not a malfunction.

2.4 LED Indicator

Status Explanation	LED Indicator Color
Power off, battery charging	Red
Power off, battery full charged	LED light off
Power on, battery charging	Red
Power on, battery full charged	Green
Standby / Standby and screen off	Green
Recording/ Recording and screen off	Flash red

2.5 Powering the Device On / Off and Reset

2.5.1 Auto Power On/Off

If the device is connected to the vehicle power supply, once start the car engine, the device will automatically power on and start recording.

Once the vehicle engine shuts down, the device automatically saves the recording and turns off the power within 10 seconds.

2.5.2 Manual Power On/Off

To manually turn on the power, press the **POWER** button.

To turn off, press and hold the **POWER** button for at least 2 seconds.

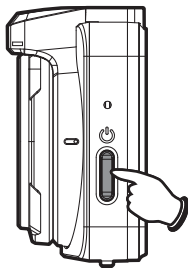

2.5.3 Reset

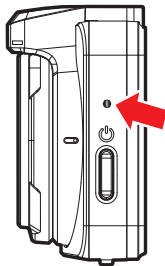

In case the device fails to function normally due to unknown causes, please use a pin or paper clip to insert and hold the Reset hole for 5 seconds to restart the device.



2.6 Initial Settings









Before using the device, we recommend you setup the correct **Time zone, Date and Time**.

Note:

Please note that if you press the  /  button during recording, the system will stop recording and enter OSD menu. Make sure the recording is already stopped then continue operating the menu.

2.6.1 Set Time Zone

To set the time zone, do the following:

1. Press the  /  button to enter the OSD menu.
2. Press the  or  button to select **Set Time Zone**, and then press the  button for entering function menu.
3. Press the  or  button to set the current time zone, and then press the  button to complete setting.
4. Press the  button to return to recording screen.



Greenwich Mean Time (GMT) map of time zones:











Note:

1. If **Satellite Synchronization** is on, device clock will be calibrated via satellite clock signal based on **Set Time zone**. Please refer to **Satellite Synchronization** (4.1).
2. If satellite positioning is not successful, device clock will run based on user defined time.

2.6.2 Set the Date / Time

To set the correct date and time, do the following:

1. Press the  /  button to enter the OSD menu.
2. Press the  or  button to select **Date / Time**, and then press the  button for entering function menu.
3. Press the  or  button to adjust the value, and then press the  button to set the next field.



4. Repeat step 3 until the date and time setting is completed.
5. Press the  button return to recording screen.

Note:

To ensure the accuracy of the video file time, please reset the date and time when the battery power runs out or when not in use over 7 days.

3 Using the Drive Recorder

3.1 Automatic Record

Once start the car engine, the device will automatically power on and start recording.

Recording will automatically stop when the engine is switched off.

















Note:

1. Some vehicle power supply would not turn on / off automatically with the car engine start, if the device cannot automatically power on / off with the car engine, please manually connect the power supply with the vehicle power, and then power on, or manually power off the device and then release the connector with the vehicle power supply.
2. It can be configured to save a video file for every 30 seconds, 1 or 3 minutes of recording. Please refer to **Record Interval** (4.1).
3. All the videos and photos are saved in the memory card, if memory card is full, loop recording will generally overwrite the oldest video file.

3.1.1 The Recording Screen





No.	Icon	Item	Description
1	110km/h	Speed	Current driving speed.
2	GPS:1	Satellite Positioning icon	Indicates the strength of satellite positioning. If the GPS:0 icon shows on screen, it indicates that the device cannot complete the satellite positioning.
3	● 00:10	Recording Duration	Indicates the video current duration.
4	2017/01/01 12:00:10	Date / Time	Indicates the current recording date and time.
5		Menu Button	During video recording, press the / button to enter the OSD menu.
6		Add Speed Point Button	During video recording, press the / button to add a speed cam point.

7		PIV (Picture in Video) Button	Press  /  to capture video screen shots from the front camera.
8		Emergency Recording Button	During video recording, press the  /  button to enter emergency recording mode. Please refer to Emergency Recording (3.1.2).
9		Voice Record Button	During video recording, press the  /  button to switch the voice recording.
10		Voice Record icon	Setting of activating audio in the video.  indicates voice recording sets as ON, while  indicates the voice recording sets off, and the sound will not be recorded. Please refer to Voice Record (4.1).
11		Resolution icon	Indicates the video resolution.
12		TF Card	When a compatible memory card is inserted, the LCD displays  . If no memory card is inserted or if the memory card is damaged / incompatible, the LCD displays  .
13		Battery icon	Indicates battery power and charging status.

3.1.2 Emergency Recording

To Start the Emergency Recording, do the following:

1. During Video Recording, press the  /  button to enter emergency recording mode, the “**Emergency**” message will be shown immediately on the upper left corner of the screen, and the recorded file will be protected.





2. The emergency video recording length is same as the recording interval setting. When the emergency recording length reaches the setting, the system will return to the general recording mode. Please refer to **Record Interval** (4.1).

Note:

1. If the **Collision Detection** function is enabled and a collision is detected, the device will automatically trigger the emergency recording. Please refer to **Collision Detection** (3.5).
2. The emergency file is created as a new file and save in Event folder, which will be protected to avoid being overwritten by normal loop recording. The emergency video folder will occupy 40% of available memory card capacity. For example, if you use 8GB memory card, about 3.2GB memory space will be saved for emergency files. When the event folder is full, the oldest emergency file will be automatically deleted by the newest emergency file.

3.2 Add Speed Point

You may customize speed cam positions in this product.



1. When the GPS positioning is completed , press  /  to update speed camera points.
2. This product features a capacity of 200 speed cam positions. In case you are trying to add more than that the system prompts with message "**Speed Position is full**".

Note:

You may delete custom speed cam positions by selecting the **Delete Last Position** or **Delete All Position** option from the **Speed Position Management** menu. Please note that all of your existing speed cam positions are deleted once the **Delete All Position option** is selected. Make sure you are ready to recreate your custom speed cam positions before running this option.

3.3 Picture in Video

You can use this device to take snapshots of the current scene.

1. In recording status, press  /  to capture recording screen shots from the front lens.
2. When the icon  shows in the central of screen, it means the screenshots is completed.



Note:



1. The screen shots image resolution quality is depending on the video resolution setting. Please refer to **Resolution** (4.1).
2. The picture resolution is limited by the speed of the target object and changes in ambient lighting. The photograph function is better used for taking still pictures in accident scenes or when the car is stopped to wait for a traffic light.



3.4 Parking Mode

To monitor the vehicle when it is parked, you can activate **Vibration Detection**, or **Motion Detection**.

Follow the steps below to change the settings for Parking Mode:

1. Press the  /  button to enter the main menu.

2. Press the  or  button to select **Parking Mode**, and then press the  button to confirm.

3. Press the  or  button to configure Parking Mode (Off / Vibration Detection / Motion Detection), and then press the  button to complete setting.

4. Press the  button to return to recording screen.

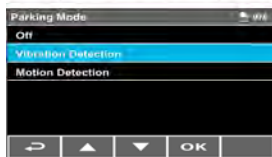

- **Off:** No parking monitoring activated.
- **Vibration Detection:**
 - If disconnected external power supply when the device is powered on, the system alert message "**Press OK to power off or enter Vibration Detection after 10 sec**". This means the system will power off and enter Vibration Detection automatically in 10 seconds.
 - Once Vibration Detection Mode is triggered, when the device detects any vibration, it will automatically power on and start recording, the event will be recorded for 60 seconds (per file).
 - In this mode, the device is powered off until event happens. This mode is more power saving.
 - To disable this function, in the vibration detection recording, press any key to wake up the screen, and resume to normal loop recording; or when the car

engineer is started again, it will be back to normal loop recording.

• **Motion Detection:**









- If disconnected external power supply when the device is powered on, the system alert message "**Press OK to power off or enter Parking mode after 10 sec**". This means the system will enter Motion Detection automatically in 10 seconds, and then LCD screen turns off (the device will turn off the screen temporarily, but still in standby detection status. Press any button to turn on the operation screen and resume to normal loop recording).
- In the Motion Detection mode, when the device detects any motion in front of lens, the automatic record will be activated.
- In this mode, when the device detects any motion in front of lens, the video recording will be triggered and the event will be recorded for 10 seconds (per file). If the event lasts more than 10 seconds, the device will keep recording up to 2 minutes.
- In this mode, the device is in standby mode until event happens. This mode will consume more battery power.
- To disable this function, in the standby mode or motion detection recording, press any key to wake up the screen, and resume to normal loop recording; or when the car engineer is started again, it will be back to normal loop recording.

Note:

1. If battery in a fully charged condition, it can record about 30 minutes video in **Motion Detection** mode. As the device is used, the battery storage capacity will decrease gradually. This is a normal phenomenon for the battery.
2. The video files taken in Vibration Detection mode will be saved in Event recording folder, which will not be overwritten by normal video files.
3. The video files taken in Motion Detection mode will be saved in normal recording folder.

3.5 Collision Detection

If the **Collision Detection** function is enabled, this device begins emergency recording once it detects any collision. Sensitivity of the Collision Detection function is set to Normal by default, if user wants to change the settings of Collision Detection, do the following:

1. Press the  /  button to enter the OSD menu.
2. Press the  or  button to select **Collision Detection**, and then press the  button for entering function menu.
3. Press the  or  button to change the sensitivity of this device's collision detection (Off / High Sensitivity / Normal Sensitivity / Low Sensitivity), and then press the  button for entering function menu.

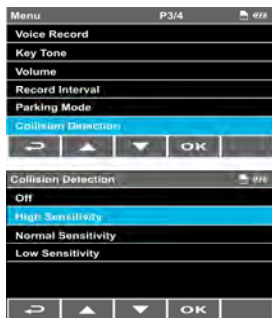



4. Press the  button return to recording screen.



3.6 Playback Videos and Photos

3.6.1 Playback

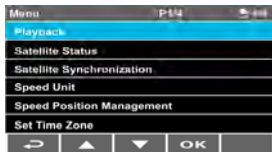

1. Press the  /  button to enter the OSD menu.

2. Press the  or  button to select **Playback**, and then press the  button for entering function menu.

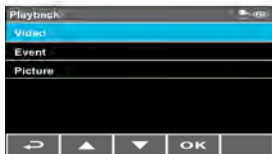

3. Press the  or  button to select file types (Video / Event / Picture), and then press the  button for entering menu.



4. Press  or  button to browse the files, select the file and then press  button to enter **Playback Mode**.



5. Press the  repetitively to return recording screen.

3.6.2 Playback Mode





Video Playback Screen

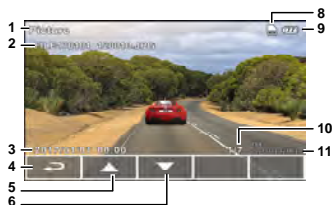

Picture Playback Screen











No.	Icon	Item	Description
1	Video	File Type	Indicates the type of the currently playing file.
2	FILE170101 120000F.MOV	File Name	Indicates the file name of video / picture.
3	00:10 / 01:00	Duration / Total recorded time	Indicates the video elapsed time / Indicates total recorded time.
	2017/01/01 12:00	Date and time	Date and time of photo taking.
4		Return	Press the button to return preview screen of video or picture. Press the button repetitively to return recording screen.
5		Previous File Button	Press button to view previous file.
6		Next File Button	Press button to view next file.
7		Playback/ Pause button	Press the / / button to play or pause the video.

No.	Icon	Item	Description
8		TF Card	When a compatible memory card is inserted, the LCD displays  . If no memory card is inserted or if the memory card is damaged / incompatible, the LCD displays  .
9		Battery icon	Indicates battery power and charging status.
10	1/7	Serial Number	Shows the current file serial number and total file number.
11	FILE 20170101 12:00:10	Time Stamp	Indicates the date and time of the video or photo.



3.7 Deleting Files

To delete file(s), perform the following steps:



1. Press the  /  button to enter the OSD menu.
2. Press the  or  button to select **File Deletion**, and then press the  button for entering function menu.
3. Press the  or  button to select file types (Video / Event / Picture), and then press the  button for entering menu.

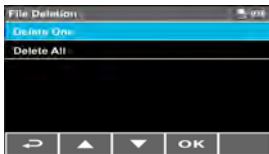

- **Delete One:**

- Press the  or  button to select **Delete One**, and then press  button to enter the menu.



- Press  or  button to browse files , select the files you want to delete and then press  button to enter the menu.



- Press the \triangle or ∇ button to select item, and then press the OK or Return button to confirm or cancel the selection.

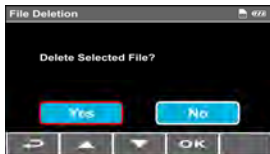

- **Delete All:**

- Press the \triangle or ∇ button to select **Delete All**, and then press OK button to delete all files in this file type.

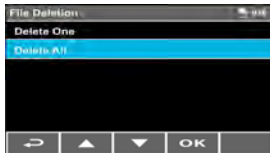

4. Press the Return repetitively to return recording screen.



Note:

Deleted files CANNOT be recovered. Ensure the files you wish to preserve are backup before deletion.

4 Adjusting the Settings

4.1 Menu Items

Refer to the below table for details of main menu and function list.

Menu option	Description	Available option
Playback	Select the file category that you want to view.	Video / Event / Picture
Satellite Status	Displays the current state of the satellite reception.	
Satellite Synchronization	If the satellite time is enabled, the drive recorder clock will synchronize according to the satellite time zone you set. When you turn on this feature, it will display the satellite time preferentially, and cannot be manually changed.	On / Off
Speed Unit	The system displays the speed setting unit.	KM/H / MPH
Speed Position Management	Add Speed Point: The satellite positioning will manually add speed camera location. You can add up to 200 speed camera locations to the built-in system. Delete Last Position: Delete the last speed camera point. Delete All Position: Delete all speed camera point.	Add Speed Point / Delete Last Position / Delete All Position
Set Time Zone	Set the time zone you are in.	Press the  /  button to set the satellite time. You may customize it between GMT -12:00 ~ GMT +13:00

Menu option	Description	Available option
Date / Time	Set the date and time.	Press the \triangle/∇ button to adjust the value, and then press the OK button to set the next field, and complete setting
Language	Language setting.	English / Español/ Deutsch/ Italiano/ Français/ Nederlands
Time Stamp	If the time stamp is enabled, recording files or photos will show the date and time.	On / Off
Resolution	Setting of video resolution.	1080P 30fps / 720P 30fps
EV	Setting of exposure value.	Press the \triangle/∇ button to set the exposure value. It can be set between -2 ~ +2
LCD Setting	Set LCD off time. device screen will be off after a set time if no operation is detected during the standby or record mode. Press any button will switch it on. (Recording is not affected when screen is off).	On / Turn Off After 7 sec. / Turn Off After 1 min. / Turn Off After 3 min.
Voice Record	Setting for activating audio in the video.	On / Off
Key Tone	Enable / disable key tone.	On / Off
Volume	Adjust the power-on sound and key tone volume.	Press the \triangle/∇ button to set the volume. It can be set between 0 ~ 10.
Record Interval	Save respective video files in a length of the selected duration.	30 sec. / 1 min. / 3 min.

Menu option	Description	Available option
Parking Mode	If one of parking mode is activated, the device will enter parking mode 10 seconds after disconnect the external power.	Off / Vibration Detection / Motion Detection
Collision Detection	If Collision Detection is activated, this device starts emergency recording once it detects any collision.	Off / High Sensitivity / Normal Sensitivity / Low Sensitivity
File Deletion	Delete the file(s).	Video / Event / Picture
Anti-flicker	Domestic power supply varies by area. It is recommended that you should check the "Table of voltage and frequency of different countries" for the correct setting.	60 Hz / 50 Hz
Format	Format the memory card inserted in the equipment. All the files in the card will be erased.	Yes / No
Default	The system reverts to the default setting.	Yes / No
Firmware Version	Indicates the current firmware version.	

5 Connecting to Other Devices

5.1 Connecting to the Computer

You can connect the device to a desktop computer or notebook to transfer or view files.

1. Connect mini USB cable to the power connector port of the device.
2. Connect the other end of USB cable to an available USB port of your computer.

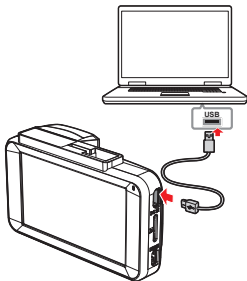

3. Power on the device, the computer screen will show up the message when the computer detects your device, select "Open folder to view files", or open the "Removable Disk", then users can save the files to your computer.

Note:





This only indicates the device can connect to the computer; mini USB cable is not included in standard package.

5.2 Connecting to TV

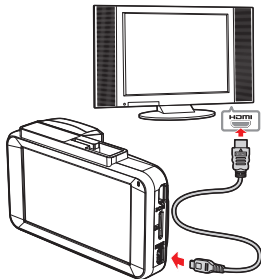
You can use HDMI cable transfer to TV to play the file.

1. Power on the device.
2. Connect HDMI cable to device HDMI port.
3. Connect HDMI cable to TV HDMI port.



4. Power on TV, switch TV signal input to HDMI, please operate by device  /  /  /  buttons.

Note:

1. It only indicates this device can connect to TV, HDMI cable is not included in standard package.
2. Please make sure the device power is on before using HDMI cable connecting to TV.

6 Installing the Software

1. Place the attached CD ROM into the CD player.
2. If the CD does not execute automatically, please use Windows File Manager to execute the Install_CD.exe file in the CD.

The following screen will be shown up.



3. Press the [Menu] item to start the installation process according to the instructions on-screen.

7 SuperCar

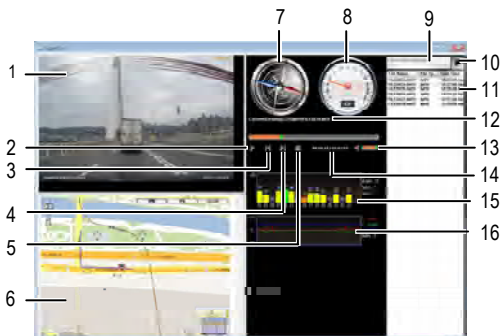

No.	Item
1	Video Player
2	Play / Pause
3	Previous
4	Next
5	Stop
6	Google Map
7	Compass
8	Speed Meter

No.	Item
9	File Path
10	Browser File
11	File List
12	File Name
13	Volume
14	Current Duration / Total Duration
15	Signal Noise Ratio (SNR)
16	G-Sensor

Note:

1. To display the route on Electronic Map, please make sure the internet is connected before starting the video playback.
2. Video files (MOV) and GPS/G-Sensor files (NMEA) must be stored in the same folder before starting the playback.
3. The SuperCar software is only applicable to Windows operating system.

8 Specifications

Item	Description
Image sensor	1/2.9" SONY sensor
Effective pixels	1920 (H) x 1080 (V)
Storage media	Supports Micro SDHC, up to 32GB class 10 speed or greater
LCD display	3" LCD color TFT
Lens	Wide Angle Fixed Focus lens Aperture: Up to F1.8
Focus range	1.5m~Infinity
Satellite System	GPS
Video	Resolution: Full HD 1920 x 1080 @ 30fps HD 1280 x 720 @30fps
	Format: MOV
Still image (Photograph)	Resolution: depends on video resolution setting
	Format: DCF (JPG)
Shutter	Electronic shutter Auto: 1/33 ~ 120~1/30 sec.
G-Sensor	3-Axis G-Force sensor
ISO	Auto
White Balance	Auto
Microphone	Built-in
Speaker	Built-in
Interface	Mini USB, A/V port, HDMI

Item	Description
Battery	Built-in Li-polymer rechargeable (This battery is NOT replaceable)
Operating Temperature	0° ~ 60° C
Operating Humidity	20 ~ 70% RH
Storage Temperature	-20° ~ 70° C
Dimensions	87.6 x 53 x 28.5 mm
Weight	Approx. 86g (without memory card)



Copyright © 2017

All rights reserved.

All other marks, products or company names mentioned in this guide are trademarks of their respective companies.



Distribution:

Rollei GmbH & Co. KG
In de Tarpen 42
D-22848 Norderstedt

Service Hotline:

+49 40 270750270

Return Service:

Rollei Service Germany
Denisstraße 28a
67663 Kaiserslautern

www.rollei.de/social
www.rollei.com/social