

**Rollei**  
since 1920



👍 gefällt mir – auf  
[facebook.com/rollei](https://facebook.com/rollei)



👍 I like – on  
[facebook.com/rollei](https://facebook.com/rollei)



## Rollei **CarDVR-110**

### **USER GUIDE**

FOR GERMAN | ENGLISH | SPANISH | ITALIAN | FRENCH  
PORTUGUESE | GREEK | DUTCH | POLISH | CZECH  
HUNGARIAN | DANISH | SWEDISH | NORWEGIAN

# Contents

About this Guide.....	3
WEEE Notice.....	3
CE Regulatory Notice.....	3
Notes on Installation.....	4
Caution.....	4
<b>1 Introduction.....</b>	<b>5</b>
1.1 Features.....	5
1.2 Package Contents.....	5
1.3 Product Overview.....	6
1.4 Remote Control.....	7
<b>2 Getting Started.....</b>	<b>8</b>
2.1 Inserting the Memory Card.....	8
2.2 Installing in Vehicles.....	9
2.2.1 Mount to Windshield.....	9
2.2.2 Adjust the device position.....	10
2.3 Connecting to Power.....	11
2.4 Powering the Device On / Off.....	12
2.4.1 Auto Power On/Off.....	12
2.4.2 Manual Power On/Off.....	12
2.5 Initial Settings.....	13
2.5.1 Set Automatic Recording.....	13
2.5.2 Set the Date and Time.....	13
<b>3 Using the Car Recorder.....</b>	<b>14</b>
3.1 Recording Videos.....	14

3.1.1	Record videos while driving.....	14
3.1.2	Record all other types of videos .....	14
3.1.3	Emergency Recording .....	15
3.1.4	The Recording Screen.....	16
3.1.5	Taking Snapshot.....	17
3.2	Playback Videos and Photos.....	18
3.2.1	Playing Videos .....	19
3.2.2	Viewing Photos .....	19
3.2.3	The Playback Screen .....	20
3.2.4	Deleting Files.....	21
<b>4</b>	<b>Adjusting the Settings.....</b>	<b>22</b>
4.1	Using the Menu .....	22
4.2	Menu Tree .....	23
<b>5</b>	<b>Installing the Software.....</b>	<b>26</b>
<b>6</b>	<b>SuperCar.....</b>	<b>27</b>
<b>7</b>	<b>Specifications.....</b>	<b>28</b>
<b>8</b>	<b>Conformity.....</b>	<b>30</b>
<b>9</b>	<b>License Statement .....</b>	<b>31</b>

## About this Guide

The content in this document is for information purpose and is subject to change without prior notice. We made every effort to ensure that this User Guide is accurate and complete.

However, no liability is assumed for any errors and omissions that may have occurred.

The manufacturer reserves the right to change the technical specifications without prior notice.

## WEEE Notice

### Disposal of Waste Electrical and Electronic Equipment and/or Battery by users in private households in the European Union



This symbol on the product or on the packaging indicates that this can not be disposed of as a household waste. You must dispose of your waste equipment and/or battery by handling it over to the applicable take-back scheme for the recycling of electrical and electronic equipment and/or battery. For more information about recycling of this equipment and/or battery, please contact your city office, the shop where you purchased the equipment or your household waste disposal service. The recycling of materials will help to conserve natural resources and ensure that it is recycled in a manner that protects human health and environment.

## CE Regulatory Notice

This equipment complies with the requirements set out in the Council Directives on the Approximation of the Laws of the Member States relating Electromagnetic Compatibility (1995/5/EC); the Low Voltage Directive (2006/95/EC); the Restriction of The Use of Certain Hazardous Substances in Electrical And Electronic Equipment Directive (2002/95/EC), Turkish EEE Directive; the Commission Regulation (EC) No 1275/2008 implementing Directive 2005/32/EC of the European Parliament and of the Council with regard to eco-design requirements for standby and off mode electric power consumption of electrical and electronic household and office equipment, and the Directive 2009/125/EC of the European parliament and of the council establishing a framework for the setting of eco-design requirements for energy-related products.

## Notes on Installation

1. Install the device near the rear-view mirror to obtain the best open-field view.
2. Make sure that the lens is within the wiping range of the windscreen wiper to ensure a clear view even when it rains.
3. Do not touch the lens with your fingers. Finger grease may be left on the lens and will result in unclear videos or snapshots. Clean the lens on a regular basis.
4. Do not install the device on a tinted window. Doing so may damage the tint film.
5. Make sure that the installation position is not hindered by the tinted window.

## Caution

- ❖ Use the authorized charger only.
- ❖ Never disassemble by yourself.
- ❖ Never short-circuit the battery.
- ❖ Dispose of the battery properly.
- ❖ Exposing the battery to open flames can cause explosion.
- ❖ Due to local laws and vehicles safety considerations, do not operate the device while driving.

# 1 Introduction

Thank you for purchasing this advanced Car Recorder. This device is specifically designed for real time video and audio recording when driving.

## 1.1 Features

- Full HD camera (1920x1080 @ 30fps)
- 2.4" LCD color screen
- Wide angle lens
- Motion detection
- Automatic Emergency recording for collision detection
- Supports SDHC up to 32GB

## 1.2 Package Contents

The package contains the following items. In case there is any missing or damaged item, contact your dealer immediately.

Car Recorder



Bracket

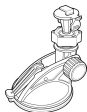

CD-ROM



Quick start guide



Car adapter



Remote control



## 1.3 Product Overview

Top and Bottom Views

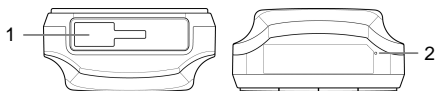

Side (Left and Right) Views

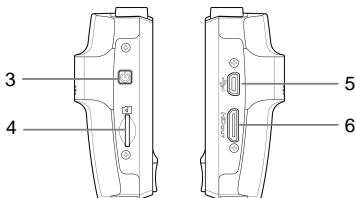

Front View

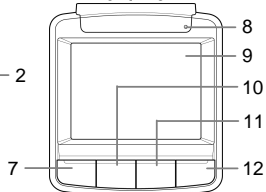

Rear View

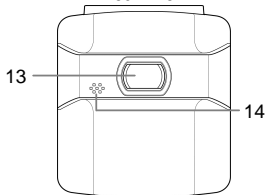

No.	Item
1	Bracket Socket
2	Microphone
3	Power Button
4	Memory Card Slot
5	USB Connector
6	HD Connector
7	Back Button (↶)

No.	Item
8	LED Light
9	LCD Panel
10	Up Button (▲)
11	Down Button (▼)
12	Enter Button (OK)
13	Wide Angle Lens
14	Speaker

**Note:**

To operate the device, press the corresponding buttons (7, 10, 11, 12) according to guide icons shown the screen.

## 1.4 Remote Control

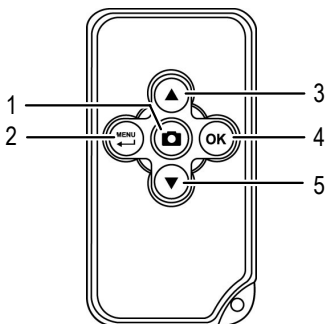

No.	Description
1	Press to take a <b>Photo</b> (📷). (Take snapshots during recording.)
2	Press to enter the menu or return to previous screen. Similar function as <b>Back Button</b> (↶).
3	Press to move up. Similar function as <b>Up Button</b> (▲).
4	Press to confirm selection. Similar function as <b>Enter Button</b> (OK).
5	Press to move down. Similar function as <b>Down Button</b> (▼).



## 2 Getting Started

### 2.1 Inserting the Memory Card

Insert the memory card with the gold contacts facing the back of the device. Push the memory card until it clicks into place.

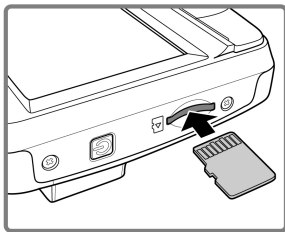

#### To remove the memory card

Push to eject the memory card out of the slot.

**Note:**

1. Do not remove or insert the memory card when the device is turned on. This may damage the memory card.
2. Please use a Class 6 memory card with at least 8GB capacity.
3. Please format the Micro SD card before you start recording.

## 2.2 Installing in Vehicles

### 2.2.1 Mount to Windshield

1. Attach the bracket to the device.  
Slide it into the bracket holder until you hear a click.

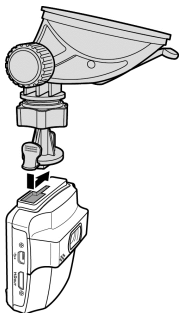

2. With the suction-cup laying flat, position the suction-cup on the windshield.
3. Hold the base firmly on the windshield and press down the clamp to mount the car holder to the windshield. Make sure the base is securely locked in place.

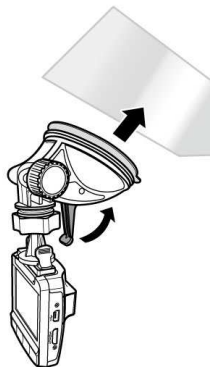

## 2.2.2 Adjust the device position

1. Loosen the knob to swivel the device vertically.

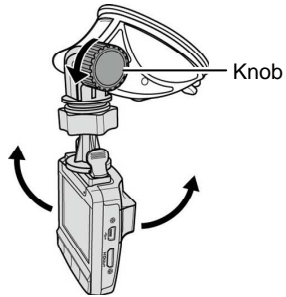

2. Loosen the knob to swivel the device horizontally up to 360°.

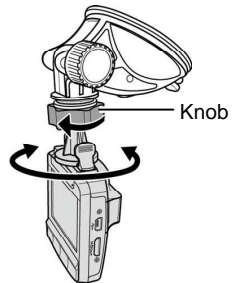

3. Then tighten the knob to make sure the device is securely locked in place.

## 2.3 Connecting to Power

Use only the supplied car adapter to power up the device and charge the built-in battery.

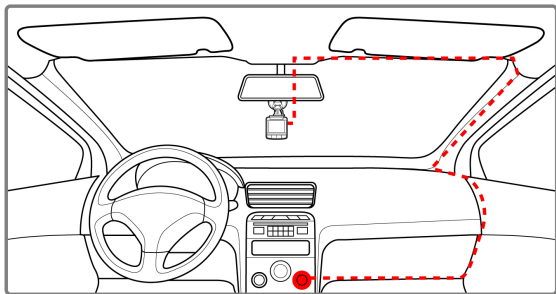

1. Connect one end of the car adapter to the USB connector of the device.
2. Plug the other end of the car charger to the cigarette lighter socket of your vehicle. Once the vehicle engine is started, the device automatically turns on.

**Note:**

1. The orange LED lights up while the battery is charging.
2. Please take note if the environment temperature reaches 45°C or above, the car adapter still can supply power to device, but it will not charge the Lithium-ion battery. This is the characteristic of Lithium-ion and is not a malfunction.

## 2.4 Powering the Device On / Off

### 2.4.1 Auto Power On/Off

Once the vehicle engine is started, the device automatically turns on. If the *Automatic Record* function is enabled, the recording will automatically start right after the device turns on.

See **Set Automatic Recording** (2.5.1).

Once the vehicle engine shuts down, the device automatically saves the recording and turns off the power within 10 seconds.

See **Delay Shutdown** (4.2).

### 2.4.2 Manual Power On/Off

To manually turn on the power, press the **POWER** button.

To turn off, press and hold the **POWER** button for at least 2 seconds.

To reset, press and hold the **POWER** button for at least 5 seconds.

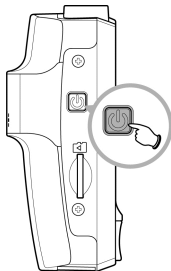



## 2.5 Initial Settings

Before using the device, we recommend you to enable the *Automatic Record* function and set up the correct date and time.

### 2.5.1 Set Automatic Recording

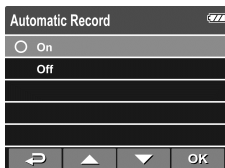

To enable the recording to start automatically after you turn on the power, do the following:

1. Press the  button to enter the OSD menu.
2. Press the  button to select **Automatic Record** and press the **OK** button.
3. Press the  button to select **On** and press the **OK** button.
4. Press the **BACK** button to exit the menu.



### 2.5.2 Set the Date and Time

To set the correct date and time, do the following:

1. Press the  button to enter the OSD menu.
2. Press the  button to select **Date / Time** and press the **OK** button.
3. Press the  button to adjust the value and press the **OK** button to move to another field.
4. Repeat step 3 until the date and time setting is complete.

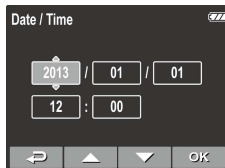

## 3 Using the Car Recorder

### 3.1 Recording Videos

#### 3.1.1 Record videos while driving

When the vehicle engine starts up and the *Automatic Record* function is enabled, the device automatically turns on and starts recording.

Recording will automatically stop when the engine is switched off. Or, press the ▼ button to stop recording manually.

**Note:**

On some cars, the recording will continue when the engine is switched off.

If this happens, do one of the following:

- Manually turn off the cigarette lighter.
- Remove the car adapter from the cigarette lighter.

#### 3.1.2 Record all other types of videos

1. Press the **OK** button to start recording.
2. Press the ▼ button to stop recording.

**Note:**

1. One video file is saved for every 3 or 5 minutes of recording. See *Using the Menu* (4.1).
2. The device saves the recording in the memory card. If the memory card capacity is full, the oldest file in the memory card is overwritten.

### 3.1.3 Emergency Recording

During Video Recording, press the **OK** button to enter emergency recording mode, the “**Emergency**” message will be shown immediately on the upper left corner of the screen, and the recorded file will be protected.

To stop the recording, press the **▼** button.







#### Note:

1. If the **Collision Detection** function is enabled and a collision is detected, the device will automatically trigger the emergency recording.
2. The emergency recording file is created as a new file, which will be protected to avoid being overwritten by normal cycling recording. 4G memory card can save up to 5 emergency video files, and 8G (or above) memory card can save up to 10 emergency video files. The alert message of “**Emergency files are full!**” will pop up on the screen when the emergency recording files are full, and the oldest emergency file will be automatically deleted when a new emergency recording file is created.



### 3.1.4 The Recording Screen



No.	Item	Description
1	Duration	Indicates the recording duration.
2	Date and time	Indicates the current recording date and time.
3	Guide icon (Menu)	Press the  button to enter the OSD menu.
4	Guide icon (Playback)	Press the  button to switch to Playback mode.
5	Resolution	Indicates the video resolution.
6	GPS icon	When a GPS fix is established, the icon  will show on the top-right corner of the screen.
7	Battery	Indicates the remaining battery power.
8	Guide icon (Stop)	Press the  button to stop the recording.
9	Guide icon (Emergency)	Press the <b>OK</b> button to continuously record the video in one file until the recording is manually stopped.

- ❖ The results of GPS positioning are only for reference, and should not affect the actual driving situation. The system also cannot ensure the positioning accuracy.
- ❖ GPS positioning accuracy may differ depending on weather and location such as high buildings, tunnels, undergrounds, or forests.  
GPS satellite signals cannot pass through solid materials (except glass). Tinted window will also affect the performance of the GPS satellite reception.
- ❖ GPS reception performance on each device may differ. The system cannot determine the accuracy of the positioning results from different devices.
- ❖ The system is used only for non-commercial use, within the maximum limits permitted by applicable law. Our company does not accept any responsibility for any data loss during the operation.
- ❖ Before you start using the system, it assumes that you agree to the above statement.

### 3.1.5 Taking Snapshot

You can also use this device to take snapshots of the current scene.

From the standby screen, press the ▼ button to take a snapshot.



**Note:**

If recording is in progress, press the ▼ button to stop the recording first.

## 3.2 Playback Videos and Photos

1. If recording is in progress, press the ▼ button to stop recording. The standby screen is displayed.
2. Press the ↶ button to enter the OSD menu.
3. Press the ▲/▼ button to select the file category that you want to browse and press the OK button.
4. Press the ▲/▼ button to view the next or the previous file and press the OK button to view the file in full screen.

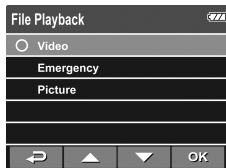

### Note:

From the standby screen, you can directly enter Playback mode by pressing ▲ button. The last recorded video is displayed on the screen.

### 3.2.1 Playing Videos

To play videos, do the following:

1. If recording is in progress, press the ▼ button to stop recording.
2. Press the ↶ button to enter the OSD menu.
3. Press the ▲/▼ button to select **File Playback** and press the **OK** button.
4. Press the ▲/▼ button to select **Video** or **Emergency** and press the **OK** button.
5. Press the ▲/▼ button to browse for the desired video file and press the **OK** button to play the video.
6. Press the **OK** button to pause the playback. Press it again to resume.







### 3.2.2 Viewing Photos

To view photos, do the following:

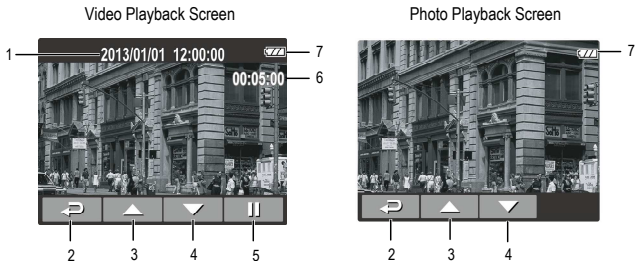
1. If recording is in progress, press the ▼ button to stop recording.
2. Press the ↶ button to enter the OSD menu.
3. Press the ▲/▼ button to select **File Playback** and press the **OK** button.
4. Press the ▲/▼ button to select **Picture** and press the **OK** button.
5. Press the ▲/▼ button to browse for the desired photo file and press the **OK** button to view the file in full screen.

### 3.2.3 The Playback Screen



No.	Item	Description
1	Date and time	Indicates the recorded date and time.
2	Guide icon (Back)	Press the  button to return to file selection display.
3	Guide icon (Previous)	Press the  button to view the previous video/photo.
4	Guide icon (Next)	Press the  button to view the next video/photo.
5	Guide icon (Pause)	Press the <b>OK</b> button to pause the video playback.
6	Duration	Indicates the elapse time.
7	Battery	Indicates the remaining battery power.

### 3.2.4 Deleting Files

To delete file(s), do the following:

1. If recording is in progress, press the ▼ button to stop recording.
2. Press the ↶ button to enter the OSD menu.
3. Press the ▲/▼ button to select **File Deletion** and press the **OK** button.
4. Press the ▲/▼ button to select the file category and press the **OK** button.

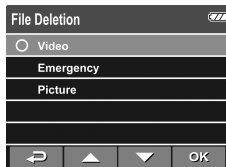

5. Press the ▲/▼ button to select the file that you want to delete and press the **OK** button to enter the Delete menu.

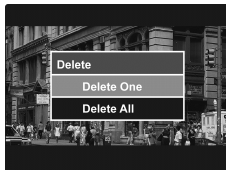

6. Press the ▲/▼ button to select an option.

Item	Description
Delete One	Delete the current file.
Delete All	Delete all files.

7. Press the **OK** button to confirm delete.

**Note:**

Deleted files cannot be recovered. Ensure the files have backup before deletion.

## 4 Adjusting the Settings

### 4.1 Using the Menu

You can customize the video recording and other general settings via the on-screen display (OSD) menus.

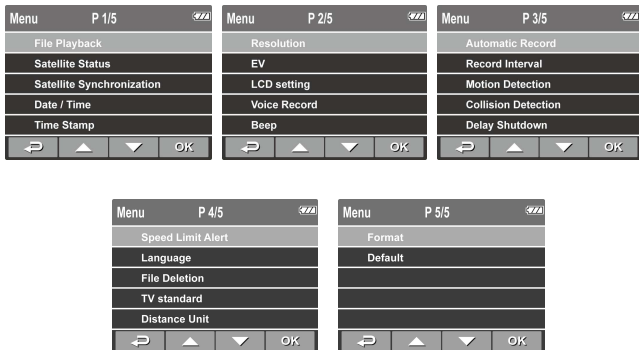

1. If recording is in progress, press the ▼ button to stop recording.
2. Press the ↶ button to open the OSD menu.
3. Press the ▲/▼ button to select a menu option and press the **OK** button to enter the selected menu.
4. Press the ▲/▼ button to select the desired setting and press the **OK** button to confirm the setting.
5. Press the ↶ button to exit the menu.

## 4.2 Menu Tree

Refer to the below table for details on menu items and available menu options.

Menu option	Description	Available option
File Playback	Select the file category that you want to view.	Video / Emergency / Picture
Satellite Status	Displays the current state of the satellite reception.	
Satellite Synchronization	Automatically synchronize with the local satellite time. When this feature is enabled, the system will use the satellite time, and you cannot manually change the time.	On / Off
Date / Time	Set the date and time.	Press ▲/▼ button to adjust the value, press the <b>OK</b> button to switch the field and confirm.
Time Stamp	Enable/Disable the date stamp.	On / Off
Resolution	Set the video resolution.	1080P(1920x1080) / 720P(1280x720)
EV	Exposure compensation	Press ▲/▼ button to adjust the value, press the <b>OK</b> button to confirm.
LCD Setting	Set the duration for the display to automatically turn off right after video recording starts.	On / Turn Off After 30 sec. / Turn Off After 3 min. / Off
Voice Record	Enable/Disable the voice recording.	On / Off
Beep	Enable/Disable the beep.	On / Off



Menu option	Description	Available option
Automatic Record	Enable / Disable the device to automatically record video after the device is turned on.	On / Off
Record Interval	Set the recording duration for each recorded video file.	3 min. / 5 min.
Motion Detection	Enable/Disable the motion detection. If this function is enabled and the power off button is pressed, the system alert message, " <b>Press OK Key to Power off, or enter motion detection after 10sec.</b> ", will pop on the screen. Under motion detection mode, the device will automatically start recording when any object movement is detected.	On / Off
Collision Detection	Enable / Disable the collision detection. If this function is enabled and any collision is detected, the device will automatically trigger the emergency recording.	High Sensitivity / Normal Sensitivity / Low Sensitivity / off
Delay Shutdown	Set the delay duration before turning off the power.	10 sec. / Off
Speed Limit Alert	Set a customized maximum speed limit. When the vehicle speed exceeds the maximum, a warning tone is automatically triggered	Press ▲/▼ button to set the speed limit. You can set the speed limit from 50km/h to 200km/h.

<b>Menu option</b>	<b>Description</b>	<b>Available option</b>
	and a warning message is displayed on the screen.	
Language	Set the on-screen display menu language.	English / Deutsch / Français / Español / Italiano / Português / Polski / Čeština / Nederlands / Ελλάδα / Dansk / Norsk / Svenska / Magyar
File Deletion	Delete the file(s).	Video / Emergency / Picture
TV standard	Set the TV type based on your local region.	NTSC / PAL
Distance Unit	Set metric units or Imperial units.	KM / MILE
Format	Format the memory card.	Yes / No
Default	Reset all settings to factory default settings.	Yes / No

## 5 Installing the Software

1. Place the attached CD ROM into the CD player.
2. If the CD does not execute automatically, please use Windows File Manager to execute the **Install\_CD.exe** file in the CD.

The following screen will be shown up.



3. Press the [Menu] item to start the installation process according to the instructions on-screen.

## 6 SuperCar

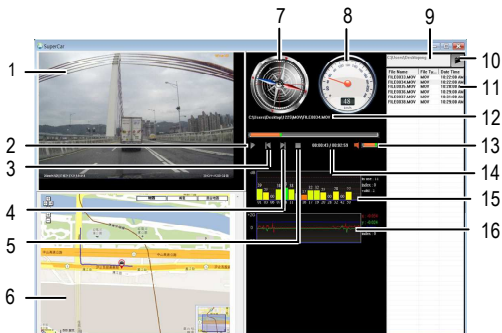

No.	Item
1	Video Player
2	Play / Pause
3	Previous
4	Next
5	Stop
6	Google Map
7	Compass
8	Speed Meter

No.	Item
9	File Path
10	Browser File
11	File List
12	File Name
13	Volume
14	Current Duration / Total Duration
15	Signal Noise Ratio (SNR)
16	G-Sensor

### Note:

1. To display the route on Google Maps, please make sure the internet is connected before starting the video playback
2. Video files (MOV / TS) and GPS/G-Sensor files (NMEA) must be stored in the same folder before starting the playback.

## 7 Specifications

Item	Description
Image sensor	1/3" CMOS sensor
Effective pixels	2304 (H) x 1536 (V)
Storage media	Support Micro SDHC up to 32GB (Suggest to use a Class 6 memory card with at least 8GB capacity)
LCD display	2.4" LCD color TFT (112K pixels)
Lens	Wide Angle Fixed Focus lens F2.4, f=3.0mm
Focus range	1.5m~Infinity
Movie Clip	Resolution: Full HD (1920 x 1080), 30fps HD (1280 x 720), 30fps
	Format: MOV
Still image (Snapshot)	Resolution: 3M (2304 x 1536)
	Format: DCF (JPEG, Exif: 2.2)
Shutter	Electronic shutter Auto:1/2 ~1/2000 sec.
G-Sensor	3-Axis G-Force sensor
ISO	Auto
White Balance	Auto
Microphone	Yes
Speaker	Yes
Interface	Mini USB, Mini C Type HDMI

Item	Description
Battery	Built-in 470mAH Li-polymer rechargeable
Operating Temperature	0° ~ 50° C
Operating Humidity	20 ~ 70% RH
Storage Temperature	-20° ~ 80° C
Dimensions	63 x 70 x 28.7 mm
Weight	Approx. 94g

## 8 Conformity

The Manufacturer hereby declares that the CE marking was applied to the Rollei CarDVR-110 in accordance with the basic requirements and other relevant provisions of the following CE Directives:

2011/65/EC RoHs Directive

2004/108/EC Low Voltage  
Directive

1999/5/EG R&TTE Directive

2006/95/EEC LVD Directive

2009/125/EG EuP Directive

2002/96/EG WEEE Directive



The EC Declaration of Conformity can be requested from the address specified on the Warranty card.

## 9 License Statement

The software used in this product is licensed subject to a license pursuant to the GNU – General Public License conditions. We expressly draw attention to the fact that under the GNU – General Public License conditions no liability is accepted.

The starting point for the software is the software published online at

<http://sg-gpl.net/>

The software listed there is licensed pursuant to the GNU – General Public License conditions.

Device-related changes have been made to this software for the product in question. The source text of the software implemented in the product in question can be obtained in response to an enquiry sent to the e-mail address

[info@rollei.com](mailto:info@rollei.com)

In this instance your e-mail must contain details of what the relevant product is, the relevant serial number and documentary evidence of your commercial source of supply as well as documentary evidence of the date on which the product was purchased from the trade source of supply. We guarantee supply of the source text of the implemented software for a period of at least three years from date of purchase from the trade source of supply where the trade source of supply has sourced the product from us directly or via strictly trade-only dealers.



**Rollei**  
since 1920

[www.rollei.com](http://www.rollei.com)



RCP-Technik GmbH & Co. KG  
Tarpen 40/Gebäude 7b  
D-22419 Hamburg  
Hotline +49 (0)6 31/3 42 84 49  
[welcome@rcp-technik.com](mailto:welcome@rcp-technik.com)

Subject to technical changes!