

Flash Unit 56F for Sony

Safety Instruction	36	2.4G wireless transmitter	51
Specification	37	Set wireless channel	51
Nomenclature	38	2.4G Master	52
Display Icons	40	2.4G Master TTL	54
Basic operation	42	2.4G Master MULTI	55
Auto-Focus Auxiliary AF Lamp	42	2.4G Slave (TTL, M, MULTI)	56
Battery Installation	43	Light Sensing Mode	57
Attach the Flash to the Camera	44	High Speed Sync	58
Turn ON/OFF power	45	Other	59
Charging Indicator	45	Signal Tones,	
Extended Interface	45	Backlight display	59
Flash light transmitter mode	46	Special status interface	59
2.4G Wireless transmitter mode	46	Custom function settings	60
Automatic flash shooting (TTL)	47	Multi Lighting Applications	61
Manual flash mode (M)	48	Disposal	62
Multi flash mode (MULTI)	49	Conformity	62
ZOOM setting	50		

Thank you for purchasing this Rollei Flash Unit.

Please read this manual carefully before using the Flash Unit and use it correctly according to the given instructions.

Safety Instruction

1. Never trigger the Flash Unit around flammable gas or liquid gas (such as gasoline and solvents)! There is the risk of explosion!
2. Neither shoot with the Flash Unit at drivers of cars, buses or trains, nor the riders of motorcycles and bicycles. They may be temporarily blind of the bright light which can cause traffic accidents.
3. Never trigger the Flash Unit directly in front of your eyes! Using the Flash Unit directly at people or animal's eyes might damage the retinas and cause serious visual disturbances, even blindness.
4. Only use the batteries listed in this manual!
5. Never place the batteries in high-temperature environment, such as under the sun or in the fire.
6. Remove the drained battery from the Flash Unit, as the alkaline liquid can exude from the battery which will damage the Flash Unit.
7. Keep the Flash Unit away from water (such as the rain).
8. Protect the Flash Unit from extremely hot or damp environment.
9. Do not put the Flash Unit in the glove box of the car dashboard. Do not put any light-proof items before or on the reflection shield when the Flash Unit will be triggered. Please take care that there is no dirt on the reflection as otherwise the high energy that the Flash Unit emits, will burn the item or damage the reflection shield.
10. Never open the Flash Unit by yourself! There will be the danger of electric shocks. Non-professional personal cannot fix the components within the Flash Unit.

Technical Features	
Guide Number	56 (ISO 100, 180mm)
Motorised Zoom	18 – 180 mm; manual / automatic zoom
TTL Flash Mode	TTL, M, 2.4 G Master, 2.4 G Slave, S1, S2, Multi
Wireless Trigger	2.4 G wireless flash, light pulse, S1/S2 optical flash
WL Visual Flash Distance	Indoor up to 30 meters Outdoor up to 50 meters
WL Transmission Range 2.4 GHz	Up to 50 meters
Swivel Reflector	Tilt angle (up and down): -7° up to +90° Rotation angle (left and right): 0° up to +180°
Slave Group and Unit	16 Slave communication channels (1 – 16) 3 Slave unit groups (A,B,C)
Color Temperature	5500 K
Flash Duration	1/200 seconds ~ 1/20,000 seconds
High Speed Synchronisation	Up to 1/8,000 seconds
Flash Control	1/128 – 1/1 step length is 0.3 EV, total 22 fine-tuning gear
Peripheral Interface	Hot shoe, PC sync, USB (for firmware updates only)
Recycle Time	3.0 seconds
Power	4x AA batteries or 4x AA Ni-MH batteries (any batteries are not included)
Lighting Time	100 ~ 1500 times
Additional Function	Sleep mode, overheating protection
Dimensions	WxHxD: 75 x 200 x 60 mm
Weight	399 g (without any batteries)

Subject to technical changes. Sony is registered trademark, Sony products are trademarks or registered trademarks of Sony.

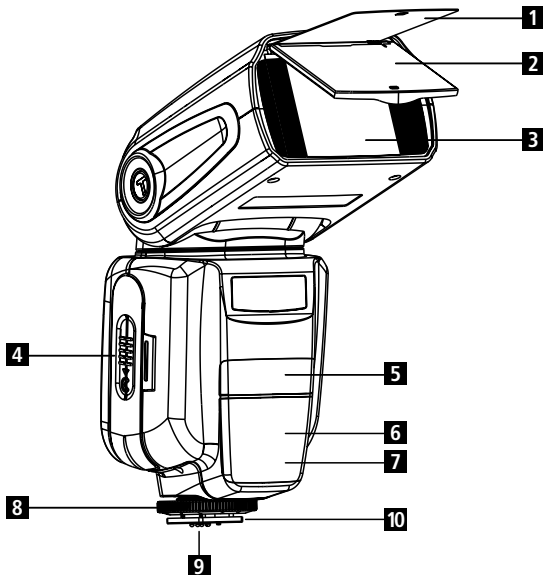

- 1** Bounce card
- 2** Wide angle diffusor
- 3** Flash head / Flash sensors
- 4** Battery compartment
- 5** Optical transmitter wireless sensor
- 6** 2.4G wireless transmitter sensor
- 7** Auto focus auxiliary lamp
- 8** Locking wheel
- 9** Pins
- 10** Hot shoe

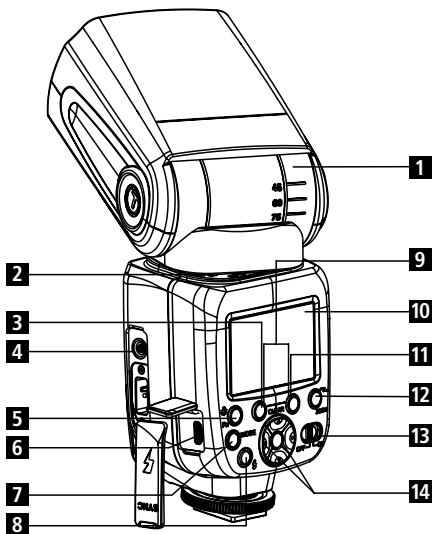

- | | |
|---|--|
| 1 Tilt angle scale | 10 LCD |
| 2 Rotation Angle | 11 Rear Curtain / high-speed sync mode select key |
| 3 Wireless option button | 12 Zoom / Wireless Settings button |
| 4 Synchronous sockets | 13 ON-OFF switch |
| 5 Backlight / custom function | 14 Keypad |
| 6 USB port | |
| 7 Mode select button | |
| 8 Test button / indicator light | |
| 9 Clear button (both pressed at the same time) | |

Display Icons

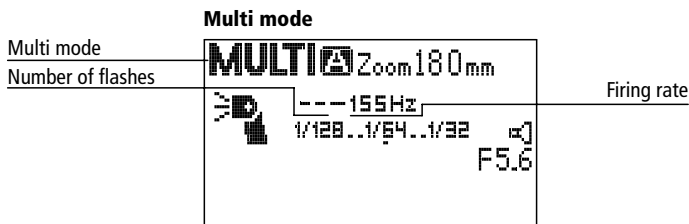
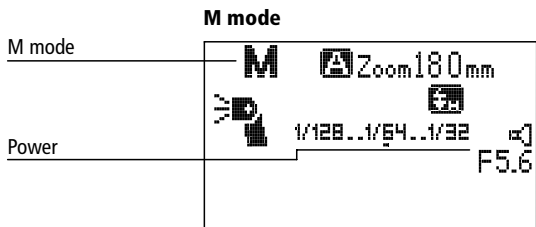
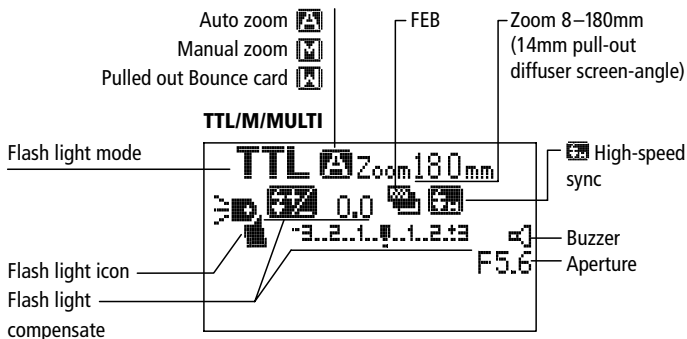

2.4G Wireless flash mode

2.4G MASTER

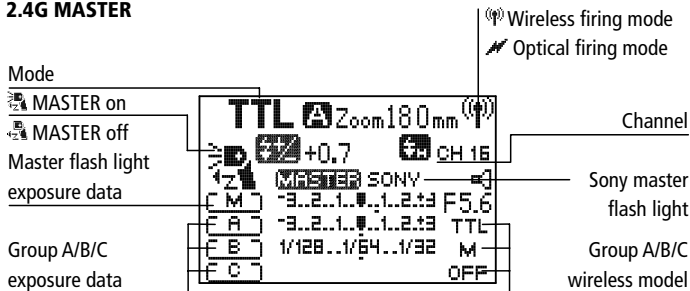

2.4G SLAVE



Optical SLAVE S1

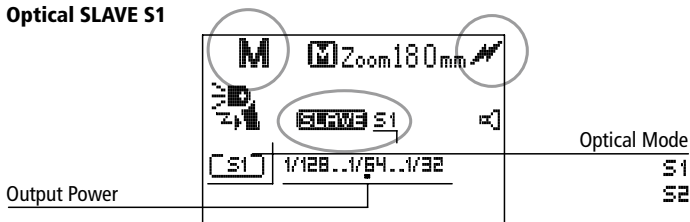

Auto-Focus Auxiliary AF Lamp

When working under dark conditions, the Automatic AF which is positioned in the middle of the flash light, may temporary project a red light to assist focusing. If this lamp disturbs the subject that should be shooted you can switch to manual focus (M) or to custom function (Fn – 08).

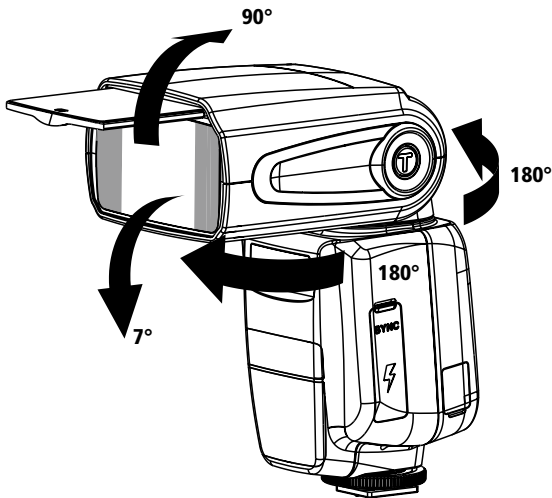

This flash unit can be rotated up to 90° and downwards up to 7°. Furthermore a horizontal rotating from "left to right" and "right to left" by 180° is possible. Rotating the flash to the ceiling or wall can make the images look more natural.

Battery Installation

1. Slide the battery compartment cover down in the direction of the small arrow.
2. Insert 4x AA alkaline batteries following the polarity markings stamped into the metal contacts on the inside of the door.
3. Close the battery compartment cover.

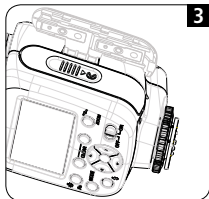
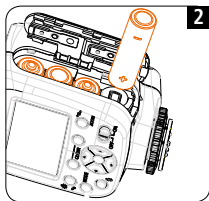
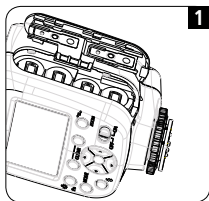

Basic operation

Attach the Flash to the Camera

1. Loosen the locking wheel at the bottom of flash.
2. Slide the flash all the way into the camera's hot shoe mount.
3. To secure the flash turn the locking wheel until it's tight.

Note:

- Make sure that the flash and camera are turned off.
- Do not forcibly pull out the flash from the camera.

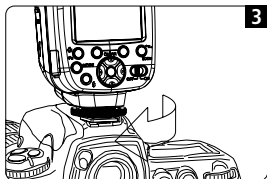
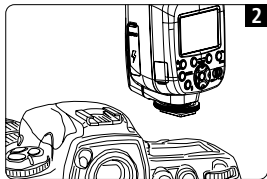
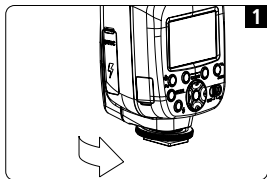

Basic operation

Turn ON/OFF power

Slide the switch from left to the right to turn it on and vice versa to turn it off.

To save battery power and prevent battery leakage, the flash unit is factory set to the following conditions by default:

If the flash will not be operated within 60 seconds, it will automatically go into the sleep mode. In this case press any button to wake up the flash. If the flash unit is not used for a long period of time, it is recommended to use the main power switch to turn it off and remove the batteries. Before removing the battery, turn off the flash. After the flash capacitor is fully charged, the flash [⚡] button lights up, indicating that the flash is ready to trigger. This means that the product can be used for the next shoot.

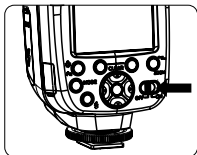

Charging Indicator

Before shooting, ensure the flash charging indicator and the camera viewfinder lamp are on.

Extended interface

Through the expansion interface there is the PC synchronous function.

Plug the sync cable into this socket to synchronize flashes.

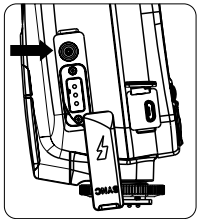
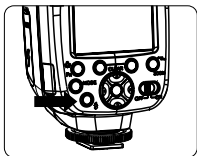

Flash light transmitter mode

Mode

1. Common flash
2. 2.4G wireless mode
3. Optical mode
4. Light sensors mode S1/S2

2.4G Wireless transmitter mode

Use flash light with 2.4G wireless transmitter function (MASTER/SLAVE). Attach the master flash (transmitter) to the camera. The transmitter's setting information can be shown on the slave light, so you don't need to operate the slave light while shooting. It is compatible with same brand flash light, studio flash light, outdoor flash and TTL remote if the products use the same system.

Wireless transmitter and optical transmitter table

Function	Wireless transmitter	Light firing
Distance	Approx. 50 meters	Approx. 15 meters
Groups	3 groups	–
Channel	Channel (1–16)	–

Flash exposure lock (FEL / FV)

The "Flash Exposure Lock" locks the correct flash exposure setting for any part of the scene. When <TTL> is displayed on the panel, please connect the flash to your camera correctly (AEL auto exposure lock) button. Then the flash will do a preflash and the camera will calculate the appropriate flash output. At this point you have time for re-composition.

After finishing you can press the shutter release for shooting pictures. (This feature requires you to use the camera support itself, therefore please refer to your camera manual settings).

Automatic flash shooting (TTL)

In TTL mode, the camera's metering system detects flash lighting from the subject and automatically adjusts the amount of flash output, allowing the subject and the background to be balanced. Exposure compensation, high speed sync, rear curtain sync and other functions are supported.



Selecting the Flash Mode

Press the mode button repeatedly until TTL is shown on the display. If master or slave is not shown on the display then the flash is in normal flash mode.



Set the flash exposure compensation value

Press the left or right button on the keypad to set the required compensation value. Press the left button to decrease the value and the right one to increase the value.

Icon "3..2..1..0..1..2..3"

The compensation rate can be set from -3.0 to +3.0

0EV → +0.3EV → +0.7EV → +1.0EV → +1.3EV → +1.7EV → → +3.0EV

0EV → -0.3EV → -0.7EV → -1.0EV → -1.3EV → -1.7EV → → -3.0EV

Flash light transmitter mode

Manual flash mode (M)

If a manual exposure is needed, you can set the value between the lowest power (1/128) and full power (1/1).

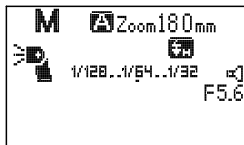

Select the flash mode

Press the mode button repeatedly until M is shown in the display.

Power settings

1. Press the left and right button of the keypad to adjust the power value.

Icon: 1/128 → 1/64 → 1/32 → ... → 1/1

Press the left button to decrease the value and the right one to increase the value.

Icon: 1/1 → 1/2 → 1/4 → ... → 1/128

2. Press the up and down button of the keypad to do the fine tuning of the power value. Press the up button to increase the value and the down one to decrease the value.

Icon: 0EV → +0.3EV → +0.7EV

Icon: 0EV → -0.3EV → -0.7EV

Multi flash mode (MULTI)

Set the camera to multi mode. When you use the strobe mode, it can emit a series of quick flashes, which allows you to perform multiple flash strokes on a single photo, freezing a series of actions in sequence. In this mode, the flash light output power, the number of flashes as well as the flash frequency (the number of flashes per second in HZ) can be set to your needs. This mode is more common when shooting moving objects. To prevent the flash light from overheating and damage, do not perform strobe flash continuous shooting for more than 10 continue times. Between two multiple exposure operations, let the light have enough time to call back. Flash 10 times, please let the light cool down for at least 15 minutes. If you are trying to perform a strobe flash burst for more than 10 consecutive strokes, to prevent flashing the lamp may overheat and the flash may stop automatically. If this happens, let the flash light cool down at least 15 minutes.



Select the flash mode

Press the mode button repeatedly until Multi is shown on the display.

Frequency setting

Press the middle button of the keypad until the frequency (HZ) is highlighted. Then press the left and right buttons to set the frequency. You can set it between 1HZ – 199 HZ.



Number of flash settings

Press the middle button of the keypad until the number is highlighted. Press the left or right button to change the number of flashes which can be set from 1–40.

Flash light transmitter mode

Exposure power setting

Press the left and right key of keypad to set flash light power.

Flash power and the number of flash relations table

Power	1/128	1/64	1/32	1/16	1/8	1/4
The number of flashes	1-40	1-20	1-12	1-8	1-4	1-2

Shutter speed = Times of flash / Flash frequency (HZ)

Zoom setting



1. Press the zoom button repeatedly until the zoom value is highlighted.
2. Then press the left and right button to set the right value.
3. Press the zoom button again to finish the input.

A	W	A	M	M	M	M	M	M	M	M	M	M
Automatic	14	Auto	18	24	28	35	50	70	85	105	135	180

Note

- A: Auto zoom, M: Manual zom, W: Pulled out wide angle diffusor
- 18–180 mm
- If zoom is adjusted manually, please ensure that the flash coverage covers the lens zoom, so that the picture will not show the edge of a shadow.

2.4G wireless transmitter

The wireless flash system can be used to make a set of various flashes and combine them to work together. Therefore you can create different lighting effects.

1. If the flash is in wireless slave mode you can still press the mode button to change the mode or the flash parameters. But if you connect this flash with a camera and you press the shutter it will not flash. Therefore you need to manually exit the slave mode.
2. The flash which is in slave mode will not go into the sleep mode to ensure that all information from the master flash can be well received.



Set wireless channel

Press the zoom button repeatedly until the channel number is highlighted. Then press the left and right button to change the channel between 1 – 16.

To set the main unit flash on / off:

You can disable the MASTER unit so that only the slave unit's flash fires.

To set the Master Flash press the zoom button repeatedly until  is blinking.

Press the left and right key to set the main flash output. When master flash function is disabled the icon  is displayed. When the Master Flash is turned on, the icon  is displayed.

2.4G wireless transmitter

2.4G Master

The wireless flash system is powered by a number of flash units with wireless flash, allowing you to create a variety of lighting effects.

Press the wireless option button to set the flash mode of the flash. The flash will be in the 2.4G wireless MASTER, 2.4G wireless SLAVE, S1 or S2 mode or you can also deactivate the wireless function.

Press the wireless option button repeatedly until the icon and [Master Sony] is shown on the display.

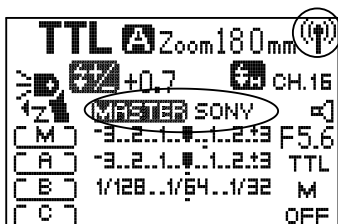

2.4G wireless transmitter

2.4G Master

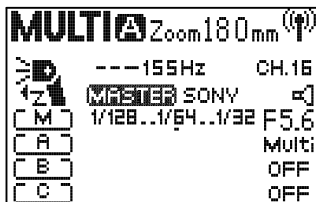
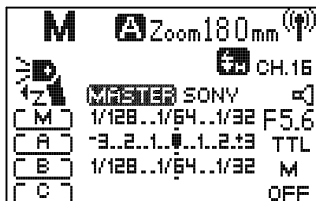
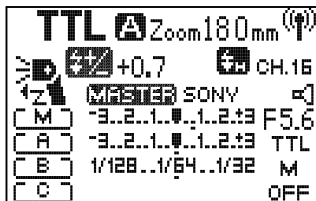

Note: You can freely set the slave unit group mode and power.

2.4G wireless transmitter

2.4G Master TTL

If the master unit is in 2.4G wireless TTL or M mode, the slave unit supports three modes: wireless off, TTL or M mode.



1. Press the mode button repeatedly to set the master unit in TTL or M mode.

2. Slave unit group settings:

Group A: Press the zoom button repeatedly until the group A is highlighted.

Press the left and right button to change the group A mode (off, TTL or M).

Press the middle button to exit or press the zoom button to enter the group B.

Group B: Press the zoom button repeatedly until the group B is highlighted.

Press the left and right button to change the group A mode (off, TTL or M).

Press the middle button to exit or press the zoom button to enter the group C.

Group C: Press the zoom button repeatedly until the group C is highlighted.

Press the left and right button to change the group A mode (off, TTL or M).

Press the middle button or the zoom button to exit.

3. Power settings for each slave unit

If all slave units have a mode (TTL or M) you can set the power of each group.

Therefore press the middle button repeatedly until group A is highlighted. Press the left and right button to change the values and press the middle button again to enter the next group.

2.4G wireless transmitter

2.4G Master MULTI

If the master flash is in multi mode, the slave unit supports the modes wireless off or MULTI.

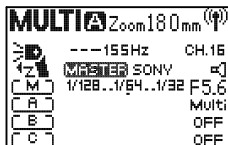

1. Press the mode button repeatedly on the master flash until multi is shown on the display.

2. Slave unit group settings:

Group A: Press the zoom button repeatedly until the group A is highlighted.

Press the left and right button to change the group A mode (off or MULTI).

Press the middle button to exit or press the zoom button to enter the group B.

Group B: Press the zoom button repeatedly until the group B is highlighted.

Press the left and right button to change the group B mode (off or MULTI).

Press the middle button to exit or press the zoom button to enter the group C.

Group C: Press the zoom button repeatedly until the group C is highlighted.

Press the left and right button to change the group C mode (off or MULTI).

Press the middle button or the zoom button to exit.

2.4G wireless transmitter

2.4G Slave (TTL, M, MULTI)

Press the wireless option button repeatedly until the icon <Ⓜ> and [SLAVE] is shown on the display.



In this mode the flash can receive signals from a TTL transmitter of a master flash. Before the shooting you need to set this flash and the transmitter to the same channel. Therefore press the zoom button repeatedly until the channel or group is highlighted on the slave unit and set it accordingly.

On the slave unit you can switch between the modes and set the power and frequency parameters but please note that as soon as a transmitter is used the flash brightness and the mode will be controlled by the transmitter. Therefore please change the modes and the flash parameters for each group on the transmitter.

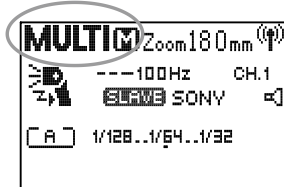
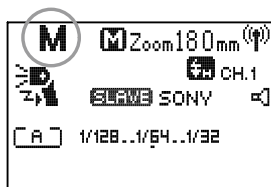

Light Sensing Mode

Light Sensing Mode (S1 / S2)

If you use the S1 or S2 mode you need to turn the flash heads into the direction of the master flash so that the sensors are facing each other.

1. Press the wireless option button repeatedly until the LCD screen shows S1 or S2 mode. These two modes can be used in TT or manual mode.
2. Within these modes you can set the output brightness in the same as way as in M mode. Just operate with the button left, right, up, down and the middle one.

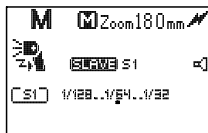

S1 Mode

It will work with the first trigger of the master flash synchronously. The master flash should be set into manual mode.

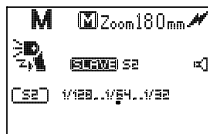

S2 Mode

It is also called pre-flash cancel mode. It can neglect the pre-flash given by TTL flash and therefore it can support the main flash working in TTL mode.

Note: If the slave flash does not sync flash with the master flash light in S1/S2 mode, please set the optical mode of the slave light and the power output correctly.

Please avoid the following situations mentioned below:

1. Avoid master light to use red eye reduction function
2. Avoid master light to use wireless mode (Sony)
3. Avoid master light to use ST-E2

Note: When the flash is in S1 or S2 mode, you can not change the mode by pressing the mode button. You need to leave the S1 or S2 mode.

High Speed Sync:

This mode allows the flash to operate in sync with the camera's high shutter speed. This is useful for outdoor shootings and portraits as well as in other situations where a large aperture is required for a strong light source. To use high speed sync press the high speed sync button while the flash is in TTL or M mode.

Note: The higher the shutter speed, the smaller is the effective flash range.

Rear curtain sync:

Using a slow shutter, you can create a ray trajectory after the subject. The flash fires before the shutter closes.

To properly use the rear curtain sync in the Sony camera body, select the "Rear" flash mode.

High Speed Syn off the camera:

In the wireless slave mode the slave unit can receive the high speed sync signal from the master unit.

Note: In the wireless slave mode the slave unit can receive the high speed sync signal from the master unit.

Signal Tones, Backlight display



Signal Tones

The sound can be turned on or off in the customize function:

1. Long ring: Call back to complete
2. Two short rings: On or call back to complete normal flash
3. Two long rings: Flash call back unfinished
4. Four short rings: The battery power is not enough
5. Continuous buzz: Flash light overheating and come into overheating protection

Backlight display

1. Shortly press the backlight button to turn on the display light.
2. If the backlight is turned on and the flash will not be used for about 15 seconds it will automatically turned off.

Special status interface



Flash high temperature alarm



Charging timeout



The battery voltage is low



Standby

Custom function settings

Custom function settings

You can customize the flash function according to your shooting preferences. Use the customization feature to complete the setup.

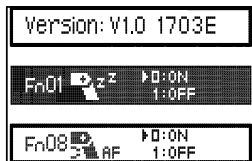

Press the backlight button for about 3 seconds to enter the custom function settings. Then select the function you want to change with the up and down buttons. Use the left and right buttons to set the function on or off.



Custom Function No.	Features	Set the number	Settings & instructions
Fn-01	Automatically turn off the power	0	On
		1	Off
Fn-08	The AF-assist light flashes	0	On
		1	Off
Fn-14	Beep switch	0	On
		1	Off
Version	Version Information		

1. 2.4G Light Applications

You can create multiple subordinate unit groups to complete the multi-directional shooting needs. This unit is not directional, casually shooting in any corner can be cited flash. The following modes can be set by the master unit: TTL, flash ratio, manual flash output, strobe and so on.

1. Wireless flash that consists of two slave unit groups

Set wireless options: SLAVE (2.4G)

Set the communication channel: 1 ~ 16

Set up grouping: Set one flash as group A and the other as group B .

Set the main control unit: Set the communication channel: set the flash modes and outputs of A and B, you can shoot flash

2. This unit consists of three slave groups

Set wireless options: SLAVE (2.4G)

Set the communication channel: 1 ~ 16

Set the grouping: Set the three flash units to A, B, and C groups respectively

Set up the main unit and shoot

Set the communication channel: Separately setting the flash modes outputs of A,B and C

Press the test button on the master unit to check whether the flash is normal:

If the slave unit is not flashing, check the communication channel and group of the flash. They need to be all the same.

Multi Lighting Applications

2. Wireless light-sensing application (S1 / S2)

Use the built-in flash or the set-top external flash as the master flash. Place the flash in a variety of directions.

In indoor use the wireless optical signal can be reflected back through the wall. So maybe more space is needed.

Due to a higher sensor sensitivity the wireless trigger sensing does have a distance of up to 15 meters when using the S1 or S2 mode outside

If a slave Flash Unit is used, test the S1 or S2 mode whether it is synchronous before shooting. Don't put any barriers between the master and slave Flash Unit. The barrier will prevent to send a wireless light signal.

Make sure that the optic control sensor is towards to the master Flash Unit. The Flash Unit should not be used under sunshine.

Wireless optical flash

If the built-in flash light or an outlay flash light is used as MASTER flash light, place flashes in different angles. The wireless channel will be reflected back by the wall indoor. So please choose more space between flash light.

Due to a higher sensor sensitivity the wireless trigger sensing does have a distance of up to 15 meters when using the S1 or S2 mode outside. If a slave Flash Unit is used, test the S1 or S2 mode whether it is synchronous before shooting.

Note: Don't put any barriers between the master and slave Flash Unit. The barrier will prevent to send a wireless light signal.

Make sure that the optic control sensor is towards to the master Flash Unit. The Flash Unit should not be used under sunshine.

Setting Position and Operation range

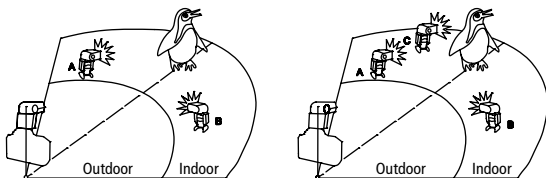

Bounce Flash

If the flash head is pointed to the wall or ceiling, the flash will be reflected by the wall. If this is illuminating then the subject, this can help to reduce shadows around the subject and get more natural effects.

Multi Lighting Applications

Adjust the flash head tilt, rotation angel and select the reflection plane

If the Flash Units' head is pitched up so that the ceiling is used as a reflection plane, this can have a good effect.

Please pay attention: Don't let the Flash Unit head directly shine to the body of a person.

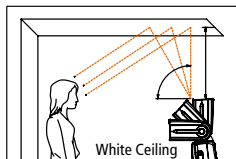

The effective distance between the Flash Unit head and the reflection plane should be about 1 m to 2 m. If colour photos are taken, please choose a white or strong reflection for flashing.

Using the Built-In Reflecting Card

The built-in reflecting card ensures that the subject will be brighter, sharper and it avoids a direct lighting in front of the subject.

- 1.) Rotate the flash head of up to 90 degrees.
- 2.) Pull out the wide panel and reflecting card.
- 3.) Pull in the wide panel and only leave the reflecting card outside.

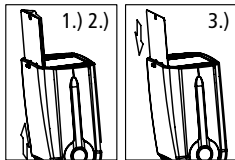
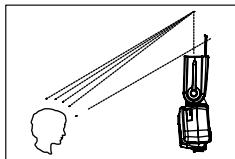

Use the Built-In Wide Angel Diffuser

This is used if you want to have a wider flash light (flare light).

1. Pull out wide diffusion plate

Slowly pull completely out the wide diffusion plate.

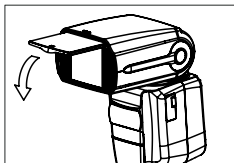

2. Push the reflector plate

Then push the reflector plate back again into the flash head.

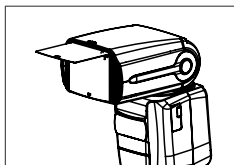

Using the Diffuser:

Attach the diffuser on the Flash Unit. The light will be softer which will help to get no shadow. This can be used in landscape as well as portrait format. The best effect can be achieved if the Flash Unit head has a position of 60 degrees.

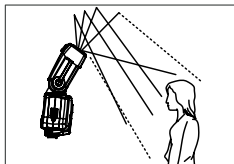
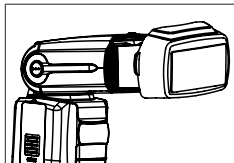

Disposal



Dispose of packaging: For disposal, separate packaging into different types. Cardboard and board must be disposed of as paper and foil must be recycled.



Disposal of old devices: Applicable in the European Union and other European countries with systems for the separate collection of reusable materials. Do not dispose old devices into the household waste! If the

Rollei Flash Unit 56F is no longer used, every consumer is legally obligated to dispose them separately from the household waste, for example, at a collection site of his community / city district. This ensures that devices are properly recycled and negative effects on the environment are avoided. Therefore electrical and electronic equipment needs to be marked with the shown symbol.

Conformity

The Manufacturer hereby declares that the CE marking was applied to the Rollei Flash Unit 56F in accordance with the basic requirements and other relevant provisions of the following CE Directives:

2011/65/EC RoHs Directive

2014/30/EU EMC Directive

2014/35/EU LVD Directive

2012/19/EC WEEE Directive

2014/53/EU RED Directive



The EC Declaration of Conformity can be requested from the address specified on the Warranty card.