

Rollei

Blitzgerät 56F

Flash Unit 56F



Gebrauchsanweisung | Instructions

in German | English | French | Spanish | Italian |
Portuguese

www.rollei.de

Blitzgerät 56F

Flash Unit 56F

Gebrauchsanweisung	4–50
Manual instruction	51–98
Notice d'utilisation	99–146
Instrucciones	147–194
Instruzioni	195–242
Instruções	243–290



Flash Unit 56F

Safety Instruction	52	Manual wireless master	
Specification	53	mode (wireless 2.4G MASTER)	
Nomenclature	54	(Canon) M	74
Display Icons	56	2.4G Master Canon MULTI	75
Basic operation	59	Master Nikon	76
Auto-Focus Auxiliary AF Lamp	59	2.4G Master (Nikon)	77
Battery Installation	60	2.4G Master Nikon TTL	78
Attach the Flash to the Camera	61	2.4G Master Nikon MULTI	79
Turn ON/OFF power	62	2.4G Slave Canon /Nikon	
Charging Indicator	62	(TTL, M, MULTI)	80
Extended Interface	62	Optical transmission	81
Flash light transmitter mode	63	MASTER Canon	81
2.4G Wireless transmitter mode	63	Master Nikon iTTL/M	83
Optical mode	63	Master Nikon MULTI	84
Automatic flash shooting (TTL)	64	Slave Nikon	85
Other Automatic Flash		Light Sensing Mode	86
Shooting Mode	65	High-speed synchronization	87
Flash bracketing (FEB)	66	Other	89
Flash exposure lock (FEL/FV)	67	Camera Menu Access (Canon	
Manual flash mode (M)	67	only newer models) ETTL	89
Multi flash mode (MULTI)	68	Signal Tones, Backlight display	89
ZOOM setting	70	Special status interface	90
2.4G wireless transmitter	71	Custom function settings	91
Set wireless channel	71	Multi Lighting Applications	92
2.4G MASTER (Canon)	72	Disposal	98
ETTL 2.4G MASTER (Canon)	73	Conformity	98

Thank you for purchasing this Rollei Flash Unit.

Please read this manual carefully before using the Flash Unit and use it correctly according to the given instructions.

Safety Instruction

1. Never trigger the Flash Unit around flammable gas or liquid gas (such as gasoline and solvents)! There is the risk of explosion!
2. Neither shoot with the Flash Unit at drivers of cars, buses or trains, nor the riders of motorcycles and bicycles. They may be temporarily blind of the bright light which can cause traffic accidents.
3. Never trigger the Flash Unit directly in front of your eyes! Using the Flash Unit directly at people or animal's eyes might damage the retinas and cause serious visual disturbances, even blindness.
4. Only use the batteries listed in this manual!
5. Never place the batteries in high-temperature environment, such as under the sun or in the fire.
6. Remove the drained battery from the Flash Unit, as the alkaline liquid can exude from the battery which will damage the Flash Unit.
7. Keep the Flash Unit away from water (such as the rain).
8. Protect the Flash Unit from extremely hot or damp environment.
9. Do not put the Flash Unit in the glove box of the car dashboard. Do not put any light-proof items before or on the reflection shield when the Flash Unit will be triggered. Please take care that there is no dirt on the reflection as otherwise the high energy that the Flash Unit emits, will burn the item or damage the reflection shield.
10. Never open the Flash Unit by yourself! There will be the danger of electric shocks. Non-professional personal cannot fix the components within the Flash Unit.

Technical Features	
Guide Number	56 (ISO 100, 180mm)
Motorised Zoom	18 – 180 mm; manual / automatic zoom
TTL Flash Mode	TTL, M, FEB, 2.4 G Master, 2.4 G Slave, S1, S2, Multi
Wireless Trigger	2.4 G wireless flash, light pulse, S1/S2 optical flash
WL Visual Flash Distance	Indoor up to 30 meters Outdoor up to 50 meters
WL Transmission Range 2.4 GHz	Up to 50 meters
Swivel Reflector	Tilt angle (up and down): -7° up to +90° Rotation angle (left and right): 0° up to +180°
Slave Group and Unit	16 Slave communication channels (1 – 16) 3 Slave unit groups (A,B,C)
Color Temperature	5500 K
Flash Duration	1/200 seconds ~ 1/20,000 seconds
High Speed Synchronisation	Up to 1/8,000 seconds
Flash Control	1/128 – 1/1 step length is 0.3 EV, total 22 fine-tuning gear
Peripheral Interface	Hot shoe, PC sync, USB (for firmware updates only)
Recycle Time	3.0 seconds
Power	4x AA batteries or 4x AA Ni-MH batteries (any batteries are not included)
Lighting Time	100 ~ 1500 times
Additional Function	Sleep mode, overheating protection
Dimensions	WxHxD: 75 x 200 x 60 mm
Weight	418 g (without any batteries)

Subject to technical changes. Canon and Nikon are registered trademarks, Canon and Nikon products are trademarks or registered trademarks of Canon and Nikon.

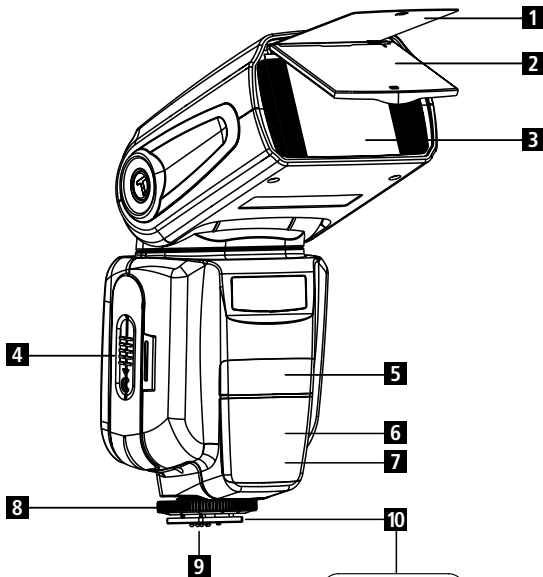

- 1** Bounce card
- 2** Wide angle diffusor
- 3** Flash head / Flash sensors
- 4** Battery compartment
- 5** Optical transmitter wireless sensor
- 6** 2.4G wireless transmitter sensor
- 7** Auto focus auxiliary lamp
- 8** Locking wheel
- 9** Pins
- 10** Hot shoe

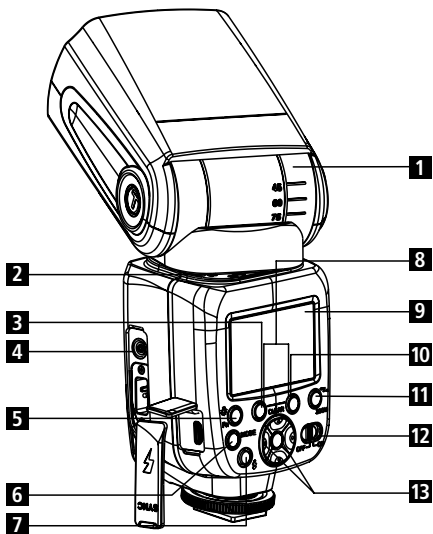

- | | |
|---|--|
| 1 Tilt angle scale | 10 Rear Curtain / high-speed sync mode select key |
| 2 Rotation Angle | 11 Zoom / Wireless Settings button |
| 3 Wireless option button | 12 ON-OFF switch |
| 4 Synchronous sockets | 13 Keypad |
| 5 Backlight / custom function | |
| 6 Mode select button | |
| 7 Test button / indicator light | |
| 8 Clear button (both pressed at the same time) | |
| 9 LCD | |

Display Icons

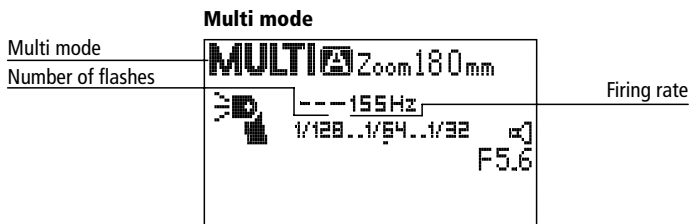
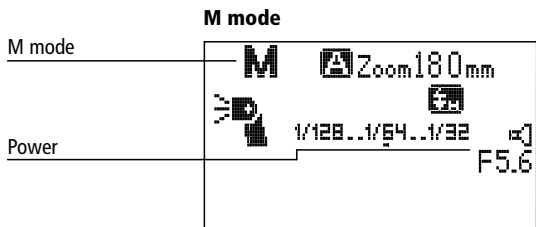
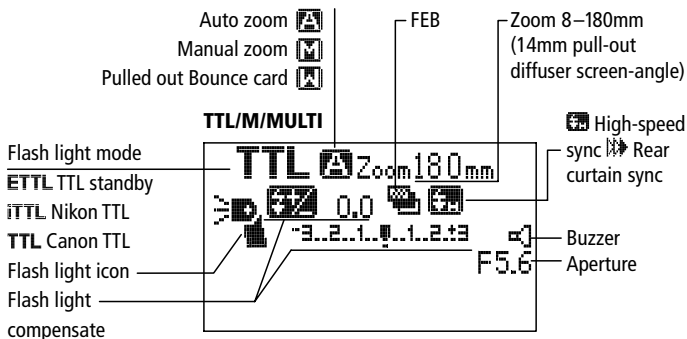

2.4G Wireless flash mode

2.4G MASTER (Canon)

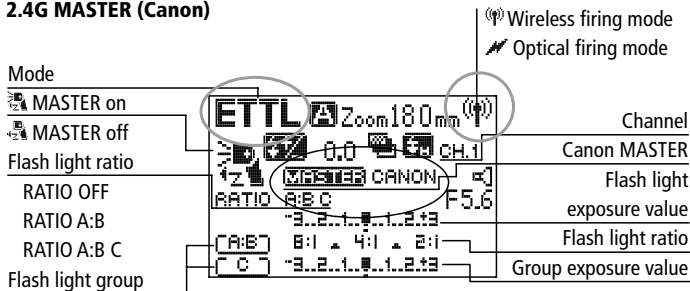

2.4G MASTER (Nikon)

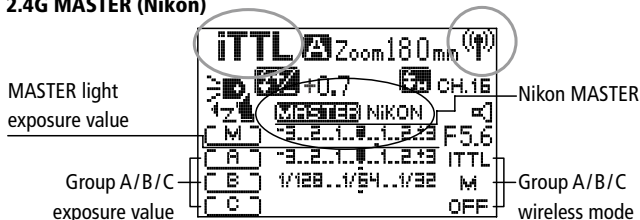

2.4G SLAVE



Display Icons

Optical mode

Optical Nikon MASTER



Optical Canon MASTER



SLAVE

Optical SLAVE

CANON Only for Canon wireless system

NIKON Only for Nikon C command system

Optical SLAVE S1

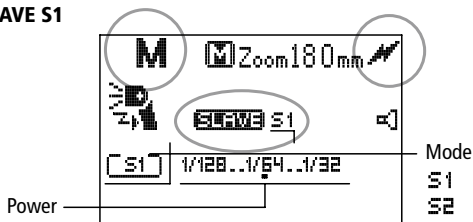

Mode

S1

S2

Auto-Focus Auxiliary AF Lamp

When working under dark conditions, the Automatic AF which is positioned in the middle of the flash light, may temporary project a red light to assist focusing. If this lamp disturbs the subject that should be shooted you can switch to manual focus (M) or to custom function (Fn – 08).

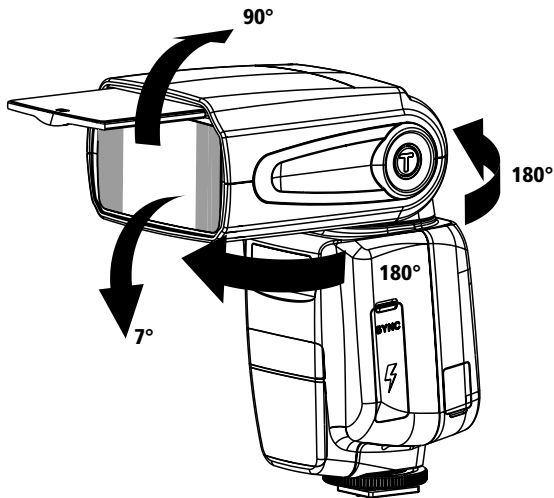

This flash unit can be rotated up to 90° and downwards up to 7°. Furthermore a horizontal rotating from "left to right" and "right to left" by 180° is possible. Rotating the flash to the ceiling or wall can make the images look more natural.

Basic operation

Battery Installation

1. Slide the battery compartment cover down in the direction of the small arrow.

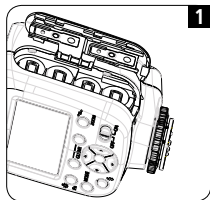

2. Insert 4x AA alkaline batteries following the polarity markings stamped into the metal contacts on the inside of the door.

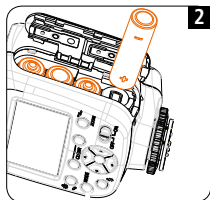

3. Close the battery compartment cover.

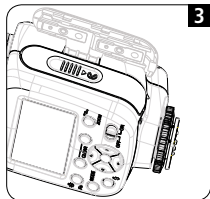

Attach the Flash to the Camera

1. Loosen the locking wheel at the bottom of flash.
2. Slide the flash all the way into the camera's hot shoe mount.
3. To secure the flash turn the locking wheel until it's tight.

Note:

- Make sure that the flash and camera are turned off.
- Do not forcibly pull out the flash from the camera.

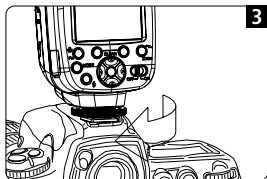
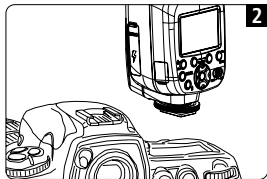
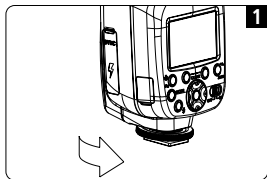

Basic operation

Turn ON/OFF power

Slide the switch from left to the right to turn it on and vice versa to turn it off.

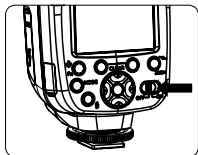

To save battery power and prevent battery leakage, the flash unit is factory set to the following conditions by default:

If the flash will not be operated within 60 seconds, it will automatically go into the sleep mode. In this case press any button to wake up the flash. If the flash unit is not used for a long period of time, it is recommended to use the main power switch to turn it off and remove the batteries. Before removing the battery, turn off the flash. After the flash capacitor is fully charged, the flash [⚡] button lights up, indicating that the flash is ready to trigger. This means that the product can be used for the next shoot.

Charging Indicator

Before shooting, ensure the flash charging indicator and the camera viewfinder lamp are on.

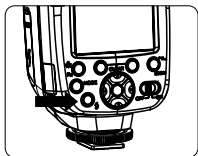

Extended interface

Through the expansion interface there is the PC synchronous function.

Plug the sync cable into this socket to synchronize flashes.

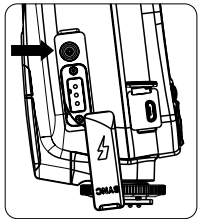

Flash light transmitter mode

Mode

1. Common flash
2. 2.4G wireless mode
3. Optical mode
4. Light sensors mode S1/S2

2.4G Wireless transmitter mode

Use flash light with 2.4G wireless transmitter function (MASTER/SLAVE). Attach the master flash (transmitter) to the camera. The transmitter's setting information can be shown on the slave light, so you don't need to operate the slave light while shooting. It is compatible with same brand flash light, studio flash light, outdoor flash and TTL remote if the products use the same system.

Optical mode

Use the flash light in the optical function (master/slave). Attach the master flash (transmitter) to the camera. The transmitter's setting information can be shown on the slave light, so you don't need to operate the slave light while shooting. Canon wireless system and Nikon C command system are supported.

Wireless transmitter and optical transmitter table

Function	Wireless transmitter	Optical transmitter	Light firing
Distance	Approx 50 meters	Approx 15 meters	
Groups	3 groups		–
Channel	Channel (1-16)	Channel (1-4)	–

Flash light transmitter mode

Automatic flash shooting (TTL)

Set the camera's shooting mode to <P> (program automatic exposure) or <□> (auto) if the flash should work automatically.



Selecting the Flash Mode

Press the mode button repeatedly until TTL mode is shown on the display. As long as no sign like MASTER or SLAVE is shown on the display, the flash is in the normal mode.



Set the flash exposure compensation value

Press the left or right button of the keypad to set the required compensation value. Press the left key to decrease the value and the right one to increase the value. Press the up and down button of the keypad to set the surrounded exposure.

Icon "3..2..1..0..1..2..3"

The compensation rate can be set from -3.0 to +3.0

0EV → +0.3EV → +0.7EV → +1.0EV → +1.3EV → +1.7EV → → +3.0EV

0EV → -0.3EV → -0.7EV → -1.0EV → -1.3EV → -1.7EV → → -3.0EV

Flash light transmitter mode

Other Automatic Flash Shooting Mode

Set the camera's shooting mode to <AV/A>(Aperture priority AE), <TV/S> (Shutter priority AE) or <M> (Manual) and you can use E-TTL / i-TTL auto flash.

TV/S	Select this mode when you want to set the shutter speed manually. The camera then automatically set the aperture matching the shutter speed to obtain a standard exposure. If the aperture display blinks, it means that the background exposure will be underexposed or overexposed. Adjust the shutter speed until the aperture display stops blinking.
AV/A	Select this mode to manually set the aperture value. The camera is automatically set to match the aperture shutter speed to achieve standard exposure. If the background is dark (such as at night), a slow sync speed will be used to obtain a standard exposure of both, the main subject and background. Use the MASTER flash for the standard exposure of your subject. Use the slow shutter background exposure standards. Since a slow shutter speed will be used for low-light scenes, using a tripod is recommended. If the shutter speed display blinks, the background will be under- or overexposed. Adjust the aperture until the shutter speed display stops blinking.
M	Select this mode if you want to set both, the shutter speed and the aperture manually. Use the MASTER flash for standard exposure. The exposure of the background is obtained with the shutter speed and aperture combination you have set.

If you use the <DEP> or <A-DEP> shooting mode, the result will be the same as using the <P> (Program AE) mode.

The flash sync speed and aperture value

	Shutter Speed Setting	Aperture Setting
P	Automatic setting (1/60 seconds to 1 / X seconds)	Automatic
TV	Manual setting (30 seconds for 1 / X seconds)	Automatic
AV	Automatic setting (30 seconds to 1 / X seconds)	Manual
M	Manual setting (bulb, 30 seconds to 1 / X seconds)	Manual

1/X seconds is the camera's maximum flash sync speed.

Flash light transmitter mode

Flash bracketing (FEB)

By using FEB the flash exposure will be automatically changed, which helps in conditions of invariable background exposure. You can take three flash shots while automatically changing the flash output according to 1/3 to plus or minus. After the FEB is done, the flash will go back to the standard settings that have been used before. (This can be turned off in the custom settings). For using FEB set your camera into the mode "single shot" and ensure that the flash is ready. Connect the Canon camera and set on the flash exposure value surrounded exposure. If a Nikon camera is connected to the flash exposure information will not be shown on the flash. You need to refer to the camera settings.

FEB Setting surrounded by exposure value (effective for Canon cameras only)



Normal firing in TTL mode

Press the up key until the icon  is shown on the display to enable FEB function.

Press the down key until the icon  is not shown on the display anymore to disable FEB function.

Increase or decrease the value

1. Press the up key to increase the value, the more often you press the up key the higher is the value. Press the down key to decrease the value again.
2. The exposure range can be set from 0 to 3.0.

Icon  ..  ..  .. 

The exposure value range is as follows:

0	0.3	0.7	1.0	1.3	1.7	2.0	2.3	2.7	3.0
---	-----	-----	-----	-----	-----	-----	-----	-----	-----

Flash light transmitter mode

Flash exposure lock (FEL/FV)

The "Flash Exposure Lock" locks the correct flash exposure setting for any part of the scene. When <TTL> is displayed on the panel, please connect the flash to your camera correctly. For Canon cameras press the "FEL" or "*" (AEL auto exposure lock) button. For Nikon cameras press "FV" button. Then the flash will do a preflash and the camera will calculate the appropriate flash output. At this point you have time for re-composition. After finishing you can press the shutter release for shooting pictures. (This feature requires you to use the camera support itself, therefore please refer to your camera manual settings).

Manual flash mode (M)

If a manual exposure is needed, you can set the value between the lowest power (1/128) and full power (1/1).



Select the flash mode

Press the mode button repeatedly until M is shown on the display.

Power settings

1. Press the left and the right button of the keypad to adjust the power value. Press the right button to increase the value and the left one to decrease the value.
Icon: 1/128 → 1/64 → 1/32 → ... → 1/1
Icon: 1/1 → 1/2 → 1/4 → ... → 1/128
2. Press the up and the down button of the keypad to do the fine-tuning of the power value. Press the up button to increase the value and the down one to decrease the value.
Icon: 0EV → +0.3EV → +0.7EV
Icon: 0EV → -0.3EV → -0.7EV

Flash light transmitter mode

Multi flash mode (MULTI)

Set the camera to M mode. When you use the strobe mode, it can emit a series of quick flashes, which allows you to perform multiple flash strokes on a single photo, freezing a series of actions in sequence. In this mode, the flash light output power, the number of flashes as well as the flash frequency (the number of flashes per second in HZ) can be set to your needs. This mode is more common when shooting moving objects. To prevent the flash light from overheating and damage, do not perform strobe flash continuous shooting for more than 10 continue times. Between two multiple exposure operations, let the light have enough time to call back. Flash 10 times, please let the light cool down for at least 15 minutes. If you are trying to perform a strobe flash burst for more than 10 consecutive strokes, to prevent flashing the lamp may overheat and the flash may stop automatically. If this happens, let the flash light cool down at least 15 minutes.



Select the flash mode

Press the mode button repeatedly until MULTI is shown on the display.



Frequency setting

Press the middle button of the keypad so often until the HZ is flashing and press the left or right button to change the frequency value. The available flash frequency can be set from 1HZ to 199 HZ.

Number of flash settings

Press the middle button of the keypad so often until the number is flashing and press the left or right button to change the value. The available flash number can be set from 1-40.

Flash light transmitter mode

ZOOM setting

Press the left and right key to adjust power in non zoom mode.

Exposure power setting

Press the left and right key of keypad to set flash light power.

Flash power and the number of flash relations table

Power	1/128	1/64	1/32	1/16	1/8	1/4
The number of flashes	1-40	1-20	1-12	1-8	1-4	1-2

Shutter speed = Times of flash / Flash frequency (HZ)

Zoom setting

Zoom setting

Press the zoom key to change the zoom value. Press the right button to increase the value and the left one to decrease the value.

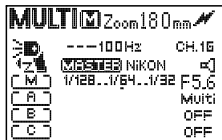

A	W	A	M	M	M	M	M	M	M	M	M	M
Automatic	14	Auto	18	24	28	35	50	70	85	105	135	180

Note

- A: Auto zoom, M: Manual zoom, W: Pulled out wide angle diffusor
- 18–180 mm
- If zoom is adjusted manually, please ensure that the flash coverage covers the lens zoom, so that the picture will not show the edge of a shadow.

2.4G wireless transmitter

The wireless flash system is composed by multiple wireless flashes. You can create a wide variety of lighting effects.

1. In the wireless flash mode, the focus indicator flashes to indicate that the flash is in slave mode. This function can be turned off in the custom function. Please note to activate the function again if needed.
2. The flash which is in slave mode will not go into the sleep mode to ensure that all information from the master flash can be well received.

Set wireless channel



Press the zoom button repeatedly until the channel no is flashing.

Press the left and right key to set the wireless channel between 1-16.

To set the main unit flash on / off:

You can disable the MASTER unit so that only the slave unit's flash fires.

To set the Master Flash press the zoom button to <  > blinking.

Press the left and right key to set the main flash output. When master flash function is disabled the icon <  > is displayed. When the Master Flash is turned on, the icon <  > is displayed.

- In MASTER mode, the slave unit has the same mode as the MASTER unit.
- In MASTER mode, the power of group A is the same as the power of MASTER unit.
- MASTER mode supports high-speed synchronization but not the rear-curtain sync.

2.4G wireless transmitter

2.4G MASTER (Canon)

Press the wireless option button repeatedly until the display shows <((P))> and <MASTER CANON>.



The flash can be used in E TTL / M / Multi mode.

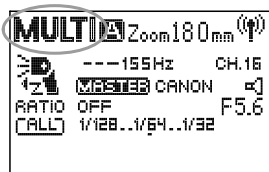

2.4G wireless transmitter

ETTL 2.4G MASTER (Canon: E TTL)

Press the mode button to set the master light to auto E-TTL mode, and make automatic flash shooting.



1. Press the mode button repeatedly until E-TTL mode is shown on the display.

2. Press the zoom button repeatedly until <RATIO OFF> is highlighted.



3. Select the flash ratio: Press the left and right button to set the flash ratio which can be <RATIO>, <RATIO A:B> or <RATIO A:B:C>. If <RATIO> is selected, all slave units will have the same output as the master flash (exposure compensation and bracketing). <RATIO A:B> means that the groups

A and B will flash and that the output bright ratio will be for the groups A and B. <RATIO A:B:C> means that the three groups will flash and the output bright ratio will be set for group A and B; and group C is the power compensation.

4. Set the flash ration <RATIO A:B> or <RATIO A:B:C>. Press the button A to <RATIO A:B> and the flash light ratio will be highlighted. Press the left and right button to set up the flash light ratio and all kinds of codes as shown below.

8:1	4:1	2:1	1:1	1:2	1:4	1:8
B:1	4:1	2:1	1:1	1:2	1:4	1:8
5.6:1	2.8:1	1.4:1	1:1.4	1:2.8	1:5.6	

2.4G wireless transmitter

- Press the middle button to C and the group C exposure compensation will be highlighted. Press the left and right button to set the flash light ratio. Press the middle button for confirmation.
- If <RATIO A: B> is set, the slave unit in the slave unit group <C> does not fire.
 - If the slave unit in the slave unit group <C> is directed toward the subject, the subject will be overexposed

Manual wireless master mode (wireless 2.4G MASTER) (Canon) M

Press the mode button repeatedly to set the master flash to the manual mode. Now the master flash can be used so send all relevant data to the slave units.



- Press the mode button repeatedly to select the m mode.
- Press the zoom button repeatedly until <RATIO OFF> is highlighted.
- Select the flash ratio: Press the left and right button to set the flash ratio which can be <RATIO>, <RATIO A:B> or <RATIO A:B:C>. If <RATIO> is selected, all slave units will have the same output as the master flash. <RATIO A:B> means that the groups A and B will flash and that the power output can be set for the group A and B. <RATIO A:B:C> means that the three groups are on and that the power output can be adjusted independently.
- Set the flash output <RATIO A:B> or <RATIO A:B:C>
 Press the middle button repeatedly until group A is highlighted on the display. Press the right or left button to adjust group A power.
 Press the middle button repeatedly until group B is highlighted on the display. Press the right or left button to adjust group B power.
 Press the middle button repeatedly until group C is highlighted on the display. Press the right or left button to adjust group C power.

2.4G Master Canon MULTI

Press the mode button repeatedly to set the master light to Multi mode. Now you can set different flash output for each slave unit and all settings can be completed with the master flash (slave and master unit mode is the same).

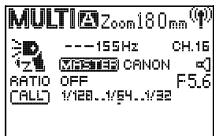

1. Press the mode button repeatedly to enter the multi mode.
2. Press the zoom button repeatedly to <RATIO OFF>.

3. Select the flash ratio

Press the left and right button to set the flash ratio. The flash ratio can be <RATIO OFF>, <RATIO A:B> or <RATIO A:B:C>. It indicates that the three slave unit groups have the same power output as the master light. Select the flash ratio <RATIO A:B> to turn on the group A and B and adjust the power output. Select the flash ratio <RATIO A:B:C> so that all three flash unit groups are on and to adjust the power output independently.

4. Set the flash output <RATIO A:B> or <RATIO A:B:C>

Press the middle button repeatedly until the frequency value is highlighted and press the left and right button to adjust the value.

Press the middle button repeatedly until the number of flashes is highlighted and press the left and right button to adjust the value.

Press the middle button repeatedly until the power of group B is highlighted and press the left and right button to adjust the value.

Press the middle button repeatedly until the power of group C is highlighted and press the left and right button to adjust the value.

2.4G wireless transmitter

Master Nikon

The wireless flash system can be combined out of many flash units and allows you to create a variety of lighting effects as simple as a regular flash.

Press the wireless select button to set the wireless flash mode. The flash will switch among 2.4G Master Canon, Nikon, 2.4G Slave Canon, Nikon, optical transmission Master Canon, Nikon, Optical transmission Slave Canon, Nikon, Wireless off. The master light is the main light and lead the slave unit which are not attached to a camera (TTL / M / Multi). There are five different slave modes: Slave 2.4G, Slave C, Slave N, S1 and S2.

Press the wireless select button repeatedly until $\langle \text{☺} \rangle$ and [Master Nikon] is shown on the display.



Note

1. In the wireless flash mode, the focus indicator flashes to indicate that the flash is in slave mode. This function can be turned off in the custom function. Please note to activate the function again if needed.
2. The flash which is in slave mode will not go into the sleep mode to ensure that all information from the master flash can be well received.

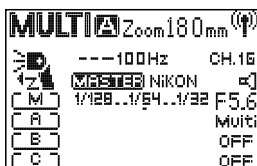
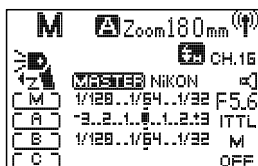

2.4G Master (Nikon)



Set the main control unit wireless channel:

Press the zoom button repeatedly until the channel number is highlighted.
Press the left and right button to adjust the wireless channel (1–16).

Set the main unit flash on / off:

If only a slave function is needed you can turn the master function off. Press the wireless setting button until  is highlighted. Press the left or right button to the master flash output. If the master function is deactivated the icon  is shown. If the master function is activated the icon  is shown.

Note

- If you have a Nikon Master unit you can select all kind of slave unit group mode and power.

2.4G wireless transmitter

2.4G Master Nikon TTL

If the master unit is in 2.4G wireless TTL or M mode, the slave unit supports three different modes: wireless off, TTL, M.



1. Press the mode button repeatedly to set the master unit to iTTL or manual mode (M).

2. Slave unit group settings

Group A: Press the wireless setup button

repeatedly until group A is highlighted. Press the left

and right button to change the group A mode. Press the middle button to exit or continue to press the wireless setup button to set the mode B.

Group B: Press the wireless setup button repeatedly to change the group B modes. Press the middle button to exit or continue to press the wireless setup button to set the mode C.

Group C: Press the wireless setup button repeatedly to change the group C mode. Press the middle button to exit.

3. Power settings for each slave unit.

Press the middle button repeatedly until group A is highlighted. Assuming that group A turns on the wireless mode's power setting and press the middle button to enter the next group setting.

2.4G wireless transmitter

2.4G Master Nikon MULTI

When the MASTER unit is in MULTI mode, the SLAVE unit supports both “Wireless Off and MULTI Mode” mode settings.

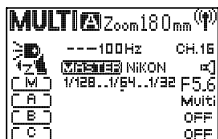

1. Press the mode button repeatedly to set the master unit into the multi mode.

2. Slave unit group mode setting

Group A: Press the wireless setup button

repeatedly until group A is highlighted. Press the left

or right button to change between the modes and press the middle button to exit or continue to enter mode B.

Group B: Press the wireless setup button repeatedly until group B is highlighted. Press the left or right button to change between the mode and press the middle button to exit or continue to enter mode C.

Group C: Press the wireless setup button repeatedly until group C is highlighted. Press the right and left button to change the modes and press the middle button to exit.

2.4G wireless transmitter

2.4G Slave Canon /Nikon (TTL, M, MULTI)

Press the wireless option button repeatedly until $\langle \text{☺} \rangle$ and [SLAVE] is shown on the display.



In this mode the flash light can receive signals from Canon and Nikon TTL Master light. It can flash although it is not attached to the camera. Before shooting set the unit to the same frequency than the sender. Press the zoom button repeatedly on the slave unit until the channel or group is highlighted and set the values.

On the slave unit you can switch between the manual and the multi mode and change parameters like power or frequency. But note that the flash brightness and the mode of the slave unit will be controlled by the transmitter if one is used. Therefore please set the mode and group on the transmitter.

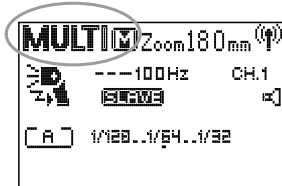
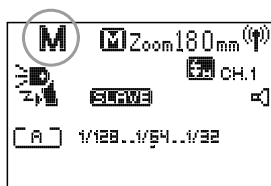

MASTER Canon

Press the wireless option button repeatedly until master canon is shown on the display.



Press the mode key to switch between TTL / M / Multi mode.



Channel setting

Press the zoom button repeatedly until the channel is highlighted. Press the left and the right button to set the channel (1-4).

Main unit Flash On / Off:

You can disable the main unit flash so that only the slave unit's flash fires.

Press the zoom button repeatedly until the master icon is highlighted. Press the left and right button to change the icon >.

 Master flash turned off.

 Master flash turned on.



MASTER Canon

Press the wireless option button repeatedly until the display shows master. Press the mode button to change between the different modes.

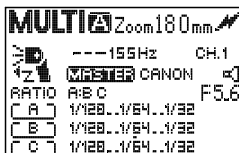
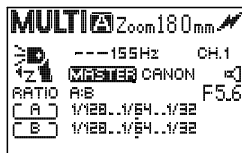
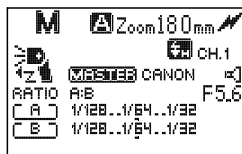

Master Nikon iTTL/M

When the MASTER unit is in command MASTER TTL mode or M mode, the SLAVE unit supports three modes: "OFF, iTTL mode and M mode".



1. Press the mode button repeatedly to set the master flash into TTL or manual mode.

2. Slave unit group mode setting

Group A: Press the zoom button repeatedly until Group A is highlighted. Press the left and right button to change the mode of group A. Press the middle button to exit and to go to the next group.

Group B: Press the zoom button repeatedly until Group B is highlighted. Press the left and right button to change the mode of group B. Press the middle button to exit and to go to the next group.

Group C: Press the zoom button repeatedly until Group C is highlighted. Press the left and right button to change the mode of group C. Press the zoom button to exit.

3. Slave unit group mode setting

Press the middle button repeatedly until group A is highlighted to set the power. After this is done press the middle button to enter into the next group.

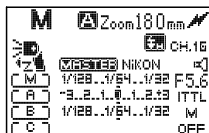

Master Nikon MULTI

When the MASTER unit is in MULTI mode, the slave unit supports both "OFF and MULTI mode" mode setting.

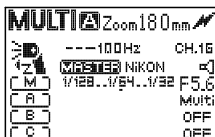

1. Press the mode button repeatedly to set the master flash into multi mode.

2. Slave unit group mode setting

Group A: Press the zoom button repeatedly until Group A is highlighted. Press the left and right button to change the mode of group A. Press the middle button to exit and to go to the next group.

Group B: Press the zoom button repeatedly until Group B is highlighted. Press the left and right button to change the mode of group B. Press the middle button to exit and to go to the next group.

Group C: Press the zoom button repeatedly until Group C is highlighted. Press the left and right button to change the mode of group C. Press the zoom button to exit.

Slave Nikon



Slave Canon indicates that only wireless flash signals from the camera flash of Canon 7D, 60D, 600D (built-in flash) and 508EX II, 600EX, ST-E2 wireless flash signals can be received.

Slave Nikon indicates that only wireless flash signals from Nikon camera flash C and SB-900, 800, 700, SU-800 of the C command signal can be received.

Slave Canon and Nikon supports 4 channels, 3 different groups, TTL, manual and multi mode. Before shooting you need to set up the same channel about the master and slave unit.

When working with the slave unit, the flash brightness and mode are fully controlled by the master flash and the slave unit displays the received information.

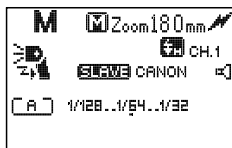

Light Sensing Mode

Light Sensing Mode (S1 / S2)

When using S1 / S2 mode, you need to turn the flash head so that the sensor is facing the master flash.

Press the wireless option button repeatedly until the display is showing S1 / S2 mode. These modes are suitable for manual flash environment and TTL flash environment.

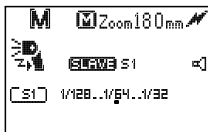

S1 Mode

It will work with the first trigger of the master flash synchronously. The master flash should be set into manual mode.

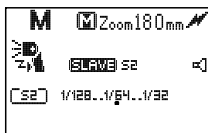

S2 Mode

It is also called pre-flash cancel mode. It can neglect the pre-flash given by TTL flash and therefore it can support the main flash working in TTL mode.

Note: If the slave flash does not sync flash with the master flash light in S1 / S2 mode, please set the optical mode of the slave light and the power output correctly.

Please avoid the following situations mentioned below:

1. Avoid master light to use red eye reduction function
2. Avoid master light to use instruction mode (Nikon) or wireless mode (Canon)
3. Avoid master light to use ST-E2



Note: When the flash is in S1 or S2 mode, you can not change the mode by pressing the mode button. You need to leave the S1 or S2 mode.

High-speed synchronization

High Speed Sync / Rear curtain sync settings

High-speed sync: Allows the flash to operate in sync with the camera's extremely high shutter speed, which is useful when shooting outdoor portraits using the flash, as well as other situations where a large aperture is required for a strong light source.

Rear-curtain sync: Using a slow shutter, you can create a ray trajectory after the subject. The flash fires before the shutter closes.

1. If you use a Canon camera you can use the high-speed / rear-curtain sync function in the E TTL or M mode. Pres the highspeedsync button repeatedly until the corresponding icon appears (no icon = normal front curtain flash /  > high speed sync /  > rear curtain sync).
2. If you uses a Nikon camera you are not able to set the high speed / rear curtain sync directly in the flash. The camera must be in "Auto FP" mode for high speed syn. Also the rear curtain sync needs to be chosen in the camera setting.

Off machine high-speed synchronization:

In the wireless slave mode the flash can receive the high speed sync from the master flash.

Note: To use high speed / rear curtain sync correctly, set the camera flash mode and shutter speed correctly.

High-speed synchronization

High speed sync with flash attached to the camera can be achieved in two ways:

1. Wireless TTL trigger (flash device itself can support high speed sync)
2. The flash is set to slave Canon or slave Nikon mode
 - a. You can also use high speed sync when the flash is not mounted on a camera in Slave Canon mode. Therefore use the manual mode and use the built-in flash as a wireless master flash. The maximum sync speed can only be set to 1/2000 or 1/250. If the built-in flash is the master flash there is also a wireless master control function needed to turn on high speed sync. If the master flash is attached to the camera it will send the high speed sync information to the slave unit.
 - b. In the slave Nikon mode you can also achieve high speed sync when it is not attached to the camera. With the Nikon C command you can use the built-in flash. Open the camera's automatic FP function therefore. If the built-in flash is used it can only send data to the slave lights, they cannot do sync flash.

Camera Menu Access (Canon only newer models) E TTL

When E TTL is used on a new camera you can also operate the flash through the camera's menu. External flash function setting and external flash custom settings, different modes (E TTL, manual, mmulti), wireless flash mode setting can be set.

Signal Tones, Backlight display



Signal Tones

The sound can be turned on or off in the customize function:

1. Long ring: Call back to complete
2. Two short rings: On or call back to complete normal flash
3. Two long rings: Flash call back unfinished
4. Four short rings: The battery power is not enough
5. Continuous buzz: Flash light overheating and come into overheating protection

Backlight display

1. Shortly press the backlight button to turn on the display light.
2. If the backlight is turned on and the flash will not be used for about 15 seconds it will automatically turned off.

Special status interface



Flash high temperature
alarm



Charging timeout



The battery voltage is low



Standby

Custom function settings

You can customize the flash function according to your needs.

To change the custom functions press the backlight button for about 3 seconds and the custom function menu opens. Select the function by using the up and down buttons and turn the function on and off by pressing the left or right button. Use the customization feature to complete the setup.



Custom Function No.	Features	Set the number	Settings & instructions
Fn-01	Automatically turn off the power	0	On
		1	Off
Fn-03	Flash bracketing is automatically canceled	0	On
		1	Off
Fn-04	Flash bracketing sequence	0	On
		1	Off
Fn-08	The AF-assist light flashes	0	On
		1	Off
Fn-14	Beep switch	0	On
		1	Off
Version	Version Information		

Note: FN number of 00 ~13 options can be accessed through the camera menu of "External flash custom function settings". The Numbers for: 00, 02, 05, 06, 07, 09, 10, 11, 12, 13 option has been disabled. (Internal Canon cameras menu).

Multi Lighting Applications

1. 2.4G Light Applications

You can create multiple subordinate unit groups to complete the multi-directional shooting needs. This unit is not directional, casually shooting in any corner can be cited flash. The following modes can be set by the master unit: TTL, flash ratio, manual flash output, strobe and so on.

1. Wireless flash that consists of two slave unit groups

Set wireless options: SLAVE (2.4G)

Set the communication channel: 1 ~ 16

Set up grouping: Set one flash as group A and the other as group B.

Set the main control unit: Set the communication channel: set the flash unit ratio A: B or A: B: C, you can shoot flash (in Canon as an example)

2. This unit consists of three slave groups

Set wireless options: SLAVE (2.4G)

Set the communication channel: 1 ~ 16

Set the grouping: Set the three flash units to A, B, and C groups respectively

Set up the main unit and shoot

Set the communication channel: Set the flash ratio of the main control unit to <A: B: C> (for Canon example)

Press the test button on the master unit to check whether the flash is normal:

If the slave unit is not flashing, check the communication channel and group of the flash. They need to be all the same.

Note: If the ratio <RATIO A: B> is set, the flash of group C will not fire.

If the group of three flash light is set <A>, they will be controlled by the MASTER flash light.

2. Light Transmission Application

You can create multiple subordinate unit groups to complete the multi-directional shooting needs. This unit is not directional, casually shooting in any corner can be cited flash. The following modes can be set by the master unit: TTL, flash ratio, manual flash output, strobe and so on.

1. Wireless flash that consists of two slave unit groups

Wireless option setting: Choose slave Canon or slave Nikon

Communication channel: 1,2,3,4

Group setting : Set one light as group A and the other light as group B.

Master unit setting :Set the communication channel: set the flash unit ratio

A: B or A: B: C, you can shoot flash (in Canon instruction as an example)

2. This unit consists of three slave groups

Wireless option setting: SLAVE CANON, SLAVE NIKON

Communication channel: 1,2,3,4

Group setting : Set the three flash units to A, B, and C groups respectively

Set up the main unit and shoot

Set the communication channel: Set the flash ratio of the main control unit to

<A: B: C> (for Canon example)

Press the test button on the master unit to check whether the flash is normal:

If the slave unit is not flashing, check the flash unit's angle to the master flash and its position to the main unit distance.

Note: If the ratio <RATIO A: B> is set, the flash of group C will not fire.

If the group of three flash light is set <A>, they will be controlled by the MASTER flash light.

Multi Lighting Applications

3. Wireless light-sensing application (S1 / S2)

Use the built-in flash or the set-top external flash as the master flash. Place the flash in a variety of directions.

In indoor use the wireless optical signal can be reflected back through the wall. So maybe more space is needed.

Due to a higher sensor sensitivity the wireless trigger sensing does have a distance of up to 15 meters when using the S1 or S2 mode outside.

If a slave Flash Unit is used, test the S1 or S2 mode whether it is synchronous before shooting. Don't put any barriers between the master and slave Flash Unit. The barrier will prevent to send a wireless light signal.

Make sure that the optic control sensor is towards to the master Flash Unit. The Flash Unit should not be used under sunshine.

Wireless optical flash

If the built-in flash light or an outlay flash light is used as MASTER flash light, place flashes in different angles. The wireless channel will be reflected back by the wall indoor. So please choose more space between flash light.

Due to a higher sensor sensitivity the wireless trigger sensing does have a distance of up to 15 meters when using the S1 or S2 mode outside. If a slave Flash Unit is used, test the S1 or S2 mode whether it is synchronous before shooting.

Note: Don't put any barriers between the master and slave Flash Unit. The barrier will prevent to send a wireless light signal.

Make sure that the optic control sensor is towards to the master Flash Unit. The Flash Unit should not be used under sunshine.

Setting Position and Operation range

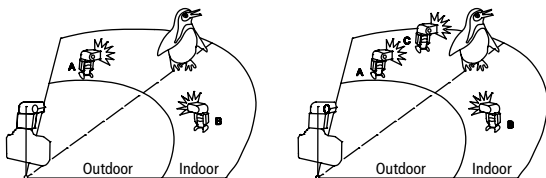

Bounce Flash

If the flash head is pointed to the wall or ceiling, the flash will be reflected by the wall. If this is illuminating then the subject, this can help to reduce shadows around the subject and get more natural effects.

Adjust the flash head tilt, rotation angle and select the reflection plane

If the Flash Units' head is pitched up so that the ceiling is used as a reflection plane, this can have a good effect.

Please pay attention: Don't let the Flash Unit head directly shine to the body of a person.

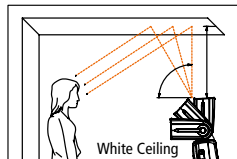

The effective distance between the Flash Unit head and the reflection plane should be about 1 m to 2 m. If colour photos are taken, please choose a white or strong reflection for flashing.

Multi Lighting Applications

Using the Built-In Reflecting Card

The built-in reflecting card ensures that the subject will be brighter, sharper and it avoids a direct lighting in front of the subject.

- 1.) Rotate the flash head of up to 90 degrees.
- 2.) Pull out the wide panel and reflecting card.
- 3.) Pull in the wide panel and only leave the reflecting card outside.

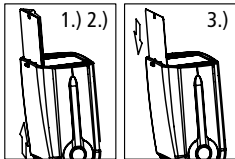
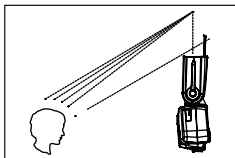

Use the Built-In Wide Angel Diffuser

This is used if you want to have a wider flash light (flare light).

1. Pull out wide diffusion plate

Slowly pull completely out the wide diffusion plate.

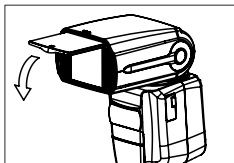

2. Push the reflector plate

Then push the reflector plate back again into the flash head.

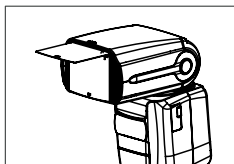

Using the Diffuser:

Attach the diffuser on the Flash Unit. The light will be softer which will help to get no shadow. This can be used in landscape as well as portrait format. The best effect can be achieved if the Flash Unit head has a position of 60 degrees.

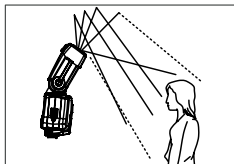
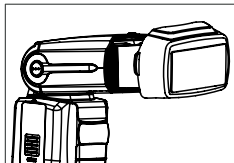



Dispose of packaging: For disposal, separate packaging into different types. Cardboard and board must be disposed of as paper and foil must be recycled.



Disposal of old devices: Applicable in the European Union and other European countries with systems for the separate collection of reusable materials. Do not dispose old devices into the household waste! If the

Rollei Flash Unit 56F is no longer used, every consumer is legally obligated to dispose them separately from the household waste, for example, at a collection site of his community / city district. This ensures that devices are properly recycled and negative effects on the environment are avoided. Therefore electrical and electronic equipment needs to be marked with the shown symbol.

Conformity

The Manufacturer hereby declares that the CE marking was applied to the Rollei Flash Unit 56F in accordance with the basic requirements and other relevant provisions of the following CE Directives:

2011/65/EC RoHs Directive
2014/30/EU EMC Directive
2014/35/EU LVD Directive
2012/19/EC WEEE Directive
2014/53/EU RED Directive



The EC Declaration of Conformity can be requested from the address specified on the Warranty card.